

53-1002446-01  
15 December 2011



# Fabric OS

---

## Administrator's Guide

Supporting Fabric OS v7.0.1

**BROCADE**

Copyright © 2011 Brocade Communications Systems, Inc. All Rights Reserved.

Brocade, the B-wing symbol, BigIron, DCX, Fabric OS, FastIron, NetIron, SAN Health, ServerIron, and Turbolron are registered trademarks, and Brocade Assurance, Brocade NET Health, Brocade One, CloudPlex, MLX, VCS, VDX, and When the Mission Is Critical, the Network Is Brocade are trademarks of Brocade Communications Systems, Inc., in the United States and/or in other countries. Other brands, products, or service names mentioned are or may be trademarks or service marks of their respective owners.

Notice: This document is for informational purposes only and does not set forth any warranty, expressed or implied, concerning any equipment, equipment feature, or service offered or to be offered by Brocade. Brocade reserves the right to make changes to this document at any time, without notice, and assumes no responsibility for its use. This informational document describes features that may not be currently available. Contact a Brocade sales office for information on feature and product availability. Export of technical data contained in this document may require an export license from the United States government.

The authors and Brocade Communications Systems, Inc. shall have no liability or responsibility to any person or entity with respect to any loss, cost, liability, or damages arising from the information contained in this book or the computer programs that accompany it.

The product described by this document may contain “open source” software covered by the GNU General Public License or other open source license agreements. To find out which open source software is included in Brocade products, view the licensing terms applicable to the open source software, and obtain a copy of the programming source code, please visit <http://www.brocade.com/support/oscd>.

## Brocade Communications Systems, Incorporated

Corporate and Latin American Headquarters  
Brocade Communications Systems, Inc.  
130 Holger Way  
San Jose, CA 95134  
Tel: 1-408-333-8000  
Fax: 1-408-333-8101  
E-mail: [info@brocade.com](mailto:info@brocade.com)

Asia-Pacific Headquarters  
Brocade Communications Systems China HK, Ltd.  
No. 1 Guanghua Road  
Chao Yang District  
Units 2718 and 2818  
Beijing 100020, China  
Tel: +8610 6588 8888  
Fax: +8610 6588 9999  
E-mail: [china-info@brocade.com](mailto:china-info@brocade.com)

European Headquarters  
Brocade Communications Switzerland Sàrl  
Centre Swissair  
Tour B - 4ème étage  
29, Route de l'Aéroport  
Case Postale 105  
CH-1215 Genève 15  
Switzerland  
Tel: +41 22 799 5640  
Fax: +41 22 799 5641  
E-mail: [emea-info@brocade.com](mailto:emea-info@brocade.com)

Asia-Pacific Headquarters  
Brocade Communications Systems Co., Ltd. (Shenzhen WFOE)  
Citic Plaza  
No. 233 Tian He Road North  
Unit 1308 - 13th Floor  
Guangzhou, China  
Tel: +8620 3891 2000  
Fax: +8620 3891 2111  
E-mail: [china-info@brocade.com](mailto:china-info@brocade.com)

## Document History

Title	Publication number	Summary of changes	Date
<i>Fabric OS Administrator's Guide</i>	53-1001763-01	Added enhancements and new features for Fabric OS v6.4.0. Added support for the Brocade VA-40FC hardware.	March 2010
<i>Fabric OS Administrator's Guide</i>	53-1001763-02	Corrected minor errors. Added additional clarification in some places.	September 2010
<i>Fabric OS Administrator's Guide</i>	53-1002148-01	Added Fabric OS v7.0.0 software features and support for new hardware platforms: Brocade 6510, DCX 8510-4, and DCX 8510-8.	April 2011
<i>Fabric OS Administrator's Guide</i>	53-1002148-02	Corrected errors and added additional explanations for some features.	June 2011
<i>Fabric OS Administrator's Guide</i>	53-1002148-03	Updated the ICL section and licensing table.	July 2011
<i>Fabric OS Administrator's Guide</i>	53-1002446-01	Added Fabric OS v7.0.1 software features and support for new hardware platforms: Brocade 6505, FC8-32E, and FC8-48E.	December 2011

# Contents

---

## About This Document

In this chapter .....	xxxiii
How this document is organized .....	xxxiii
Supported hardware and software .....	xxxiv
What's new in this document .....	xxxv
Document conventions .....	xxxvi
Notice to the reader .....	xxxvii
Additional information .....	xxxviii
Getting technical help .....	xxxviii
Document feedback .....	xxxix

## Section I

## Standard Features

### Chapter 1

#### Understanding Fibre Channel Services

In this chapter .....	3
Fibre Channel services overview .....	3
Management server .....	4
Platform services .....	4
Platform services and Virtual Fabrics .....	5
Enabling platform services .....	5
Disabling platform services .....	5
Management server database .....	6
Displaying the management server ACL .....	6
Adding a member to the ACL .....	6
Deleting a member from the ACL .....	7
Viewing the contents of the management server database .....	8
Clearing the management server database .....	9
Topology discovery .....	9
Displaying topology discovery status .....	9
Enabling topology discovery .....	9
Disabling topology discovery .....	10

Device login .....	10
Principal switch .....	11
E_Port login .....	11
Fabric login .....	11
Port login process .....	11
RSCNs .....	12
Duplicate Port World Wide Name .....	13
High availability of daemon processes .....	13

## Chapter 2

### Performing Basic Configuration Tasks

In this chapter .....	15
Fabric OS overview .....	15
Fabric OS command line interface .....	16
Console sessions using the serial port .....	16
Telnet or SSH sessions .....	17
Getting help on a command .....	18
Password modification .....	19
Default account passwords .....	19
The Ethernet interface on your switch .....	20
Virtual Fabrics and the Ethernet interface .....	20
Displaying the network interface settings .....	21
Static Ethernet addresses .....	22
DHCP activation .....	23
IPv6 autoconfiguration .....	24
Date and time settings .....	25
Setting the date and time .....	25
Time zone settings .....	26
Network time protocol .....	27
Domain IDs .....	28
Displaying the domain IDs .....	29
Setting the domain ID .....	29
Switch names .....	30
Customizing the switch name .....	30
Chassis names .....	30
Customizing chassis names .....	30
Fabric name .....	31
Configuring the fabric name .....	31
High availability considerations for fabric names .....	31
Upgrade and downgrade considerations for fabric names .....	31
Config file upload and download considerations for fabric names .....	31
Switch activation and deactivation .....	32
Disabling a switch .....	32
Enabling a switch .....	32

Switch and Backbone shutdown . . . . .	32
Powering off a Brocade switch . . . . .	32
Powering off a Brocade Backbone . . . . .	33
Basic connections . . . . .	33
Device connection . . . . .	33
Switch connection . . . . .	34

### Chapter 3

### Performing Advanced Configuration Tasks

In this chapter . . . . .	35
PIDs and PID binding overview . . . . .	35
Core PID addressing mode . . . . .	36
Fixed addressing mode . . . . .	36
10-bit addressing mode . . . . .	36
256-area addressing mode . . . . .	37
WWN-based PID assignment . . . . .	37
Ports . . . . .	39
Setting port names . . . . .	40
Port identification by slot and port number . . . . .	40
Port identification by port area ID . . . . .	40
Port identification by index . . . . .	41
Swapping port area IDs . . . . .	41
Port activation and deactivation . . . . .	42
Port decommissioning . . . . .	43
Setting port speeds . . . . .	43
Setting the same speed for all ports on the switch . . . . .	43
Setting port speed for a port octet . . . . .	44
Blade terminology and compatibility . . . . .	44
CP blades . . . . .	47
Core blades . . . . .	47
Port and application blade compatibility . . . . .	47
FX8-24 compatibility notes . . . . .	48
Enabling and disabling blades . . . . .	48
Enabling blades . . . . .	49
Disabling blades . . . . .	50
Blade swapping . . . . .	50
How blades are swapped . . . . .	51
Swapping blades . . . . .	52
Power management . . . . .	53
Powering off a port blade . . . . .	53
Powering on a port blade . . . . .	53
Equipment status . . . . .	54
Checking switch operation . . . . .	54
Verifying High Availability features (Backbones only) . . . . .	54
Verifying fabric connectivity . . . . .	55
Verifying device connectivity . . . . .	55

Track and control switch changes .....	55
Enabling the track changes feature .....	56
Displaying the status of the track changes feature.....	56
Viewing the switch status policy threshold values.....	56
Setting the switch status policy threshold values .....	57
Audit log configuration .....	58
Verifying host syslog prior to configuring the audit log .....	59
Configuring an audit log for specific event classes .....	59
Configuring FLOGI-time handling of duplicate PWWN .....	60
Setting the behavior for handling duplicate PWWNs.....	61

## Chapter 4

### Routing Traffic

In this chapter .....	63
Routing overview.....	63
Paths and route selection .....	64
FSPF .....	64
Fibre Channel NAT .....	65
Inter-switch links .....	66
Buffer credits .....	67
Virtual channels.....	67
Gateway links.....	68
Configuring a link through a gateway .....	69
Routing policies.....	70
Displaying the current routing policy .....	70
Exchange-based routing .....	71
Port-based routing.....	71
AP route policy .....	71
Route selection .....	72
Dynamic Load Sharing.....	73
Frame order delivery.....	74
Forcing in-order frame delivery across topology changes.....	74
Restoring out-of-order frame delivery across topology changes	74
Lossless Dynamic Load Sharing on ports .....	75
Lossless core .....	76
Configuring Lossless Dynamic Load Sharing .....	77
Lossless Dynamic Load Sharing in Virtual Fabrics .....	77
Enabling forward error correction .....	77
Frame Redirection.....	78
Creating a frame redirect zone .....	79
Deleting a frame redirect zone .....	79
Viewing redirect zones.....	80

## Chapter 5

### Managing User Accounts

In this chapter .....	81
-----------------------	----

User accounts overview .....	81
Role-Based Access Control .....	82
The management channel .....	83
Managing user-defined roles .....	84
Local database user accounts .....	85
Default accounts .....	85
Local account passwords .....	87
Local account database distribution .....	88
Distributing the local user database .....	88
Accepting distributed user databases on the local switch .....	88
Rejecting distributed user databases on the local switch .....	89
Password policies .....	89
Password strength policy .....	89
Password history policy .....	90
Password expiration policy .....	91
Account lockout policy .....	91
The boot PROM password .....	93
Setting the boot PROM password for a switch with a recovery string .....	93
Setting the boot PROM password for a Backbone with a recovery string .....	94
Setting the boot PROM password for a switch without a recovery string .....	95
Setting the boot PROM password for a Backbone without a recovery string .....	96
The authentication model using RADIUS and LDAP .....	97
Setting the switch authentication mode .....	99
Fabric OS user accounts .....	99
Fabric OS users on the RADIUS server .....	100
The RADIUS server .....	103
LDAP configuration and Microsoft Active Directory .....	109
Authentication servers on the switch .....	112
Configuring local authentication as backup .....	113

## Chapter 6

### Configuring Protocols

In this chapter .....	115
Security protocols .....	115
Secure Copy .....	116
Setting up SCP for configuration uploads and downloads .....	116
Secure Shell protocol .....	117
SSH public key authentication .....	117
Secure Sockets Layer protocol .....	120
Browser and Java support .....	120
SSL configuration overview .....	120
Certificate authorities .....	121
The browser .....	123
Root certificates for the Java Plug-in .....	124

Simple Network Management Protocol . . . . .	125
SNMP and Virtual Fabrics . . . . .	126
The security level . . . . .	127
The snmpConfig command . . . . .	127
Telnet protocol . . . . .	127
Blocking Telnet . . . . .	127
Unblocking Telnet . . . . .	129
Listener applications . . . . .	129
Ports and applications used by switches . . . . .	129
Port configuration . . . . .	130

## Chapter 7

### Configuring Security Policies

In this chapter . . . . .	131
ACL policies overview . . . . .	131
How the ACL policies are stored . . . . .	131
Policy members . . . . .	132
ACL policy management . . . . .	132
Displaying ACL policies . . . . .	133
Saving changes without activating the policies . . . . .	133
Activating policy changes . . . . .	133
Deleting an ACL policy . . . . .	133
Adding a member to an existing ACL policy . . . . .	134
Removing a member from an ACL policy . . . . .	134
Aborting unsaved policy changes . . . . .	134
FCS policies . . . . .	135
FCS policy restrictions . . . . .	135
Ensuring fabric domains share policies . . . . .	136
Creating an FCS policy . . . . .	136
Modifying the order of FCS switches . . . . .	137
FCS policy distribution . . . . .	137
DCC policies . . . . .	138
DCC policy restrictions . . . . .	139
Creating a DCC policy . . . . .	139
Deleting a DCC policy . . . . .	140
DCC policy behavior with Fabric-Assigned PWWNs . . . . .	141
SCC Policies . . . . .	142
Creating an SCC policy . . . . .	143
Authentication policy for fabric elements . . . . .	143
E_Port authentication . . . . .	144
Device authentication policy . . . . .	146
AUTH policy restrictions . . . . .	147
Authentication protocols . . . . .	148
Secret key pairs for DH-CHAP . . . . .	149
FCAP configuration overview . . . . .	150
Fabric-wide distribution of the Auth policy . . . . .	153



IP Filter policy .....	153
Creating an IP Filter policy .....	153
Cloning an IP Filter policy .....	154
Displaying an IP Filter policy .....	154
Saving an IP Filter policy .....	154
Activating an IP Filter policy .....	154
Deleting an IP Filter policy .....	155
IP Filter policy rules .....	155
IP Filter policy enforcement .....	158
Adding a rule to an IP Filter policy .....	159
Deleting a rule to an IP Filter policy .....	159
Aborting an IP Filter transaction .....	159
IP Filter policy distribution .....	159
Managing filter thresholds .....	160
Policy database distribution .....	160
Database distribution settings .....	161
ACL policy distribution to other switches .....	162
Fabric-wide enforcement .....	163
Notes on joining a switch to the fabric .....	164
Management interface security .....	166
Configuration examples .....	167
IPsec protocols .....	168
Security associations .....	169
Authentication and encryption algorithms .....	169
IPsec policies .....	170
IKE policies .....	170
Creating the tunnel .....	172
Example of an End-to-end transport tunnel mode .....	174

## Chapter 8

### Maintaining the Switch Configuration File

In this chapter .....	177
Configuration settings .....	177
Configuration file format .....	178
Configuration file backup .....	180
Uploading a configuration file in interactive mode .....	181
Configuration file restoration .....	181
Restrictions .....	182
Configuration download without disabling a switch .....	184
Configurations across a fabric .....	185
Downloading a configuration file from one switch to another same model switch .....	186
Security considerations .....	186
Configuration management for Virtual Fabrics .....	186
Uploading a configuration file from a switch with Virtual Fabrics enabled .....	186
Restoring logical switch configuration using configDownload .....	187
Restrictions .....	188
Brocade configuration form .....	189

<b>Chapter 9</b>	<b>Installing and Maintaining Firmware</b>	
	In this chapter . . . . .	191
	Firmware download process overview . . . . .	191
	Upgrading and downgrading firmware . . . . .	192
	Considerations for FICON CUP environments . . . . .	193
	HA sync state . . . . .	193
	Preparing for a firmware download . . . . .	194
	Connected switches . . . . .	195
	Finding the switch firmware version . . . . .	195
	Obtain and decompress firmware . . . . .	195
	Firmware download on switches . . . . .	196
	Switch firmware download process overview . . . . .	196
	Firmware download on a Backbone . . . . .	197
	Backbone firmware download process overview . . . . .	198
	Firmware download from a USB device . . . . .	201
	Enabling USB . . . . .	201
	Viewing the USB file system . . . . .	201
	Downloading from USB using the relative path . . . . .	202
	Downloading from USB using the absolute path . . . . .	202
	FIPS support . . . . .	202
	Public and private key management . . . . .	202
	The firmwareDownload command . . . . .	203
	Power-on firmware checksum test . . . . .	204
	Test and restore firmware on switches . . . . .	204
	Testing a different firmware version on a switch . . . . .	204
	Test and restore firmware on Backbones . . . . .	206
	Testing different firmware versions on Backbones . . . . .	206
	Validating a firmware download . . . . .	208
<b>Chapter 10</b>	<b>Managing Virtual Fabrics</b>	
	In this chapter . . . . .	211
	Virtual Fabrics overview . . . . .	211
	Logical switch overview . . . . .	212
	Default logical switch . . . . .	212
	Logical switches and fabric IDs . . . . .	213
	Port assignment in logical switches . . . . .	214
	Logical switches and connected devices . . . . .	215
	Logical fabric overview . . . . .	216
	Logical fabric and ISLs . . . . .	217
	Base switch and extended ISLs . . . . .	218
	Management model for logical switches . . . . .	221
	Account management and Virtual Fabrics . . . . .	221

Supported platforms for Virtual Fabrics . . . . .	222
Supported port configurations in the fixed-port switches. . . . .	222
Supported port configurations in the Brocade Backbones. . . . .	222
Virtual Fabrics interaction with other Fabric OS features . . . . .	223
Limitations and restrictions of Virtual Fabrics . . . . .	224
Restrictions on XISLs . . . . .	225
Restrictions on moving ports . . . . .	225
Enabling Virtual Fabrics mode . . . . .	225
Disabling Virtual Fabrics mode . . . . .	226
Configuring logical switches to use basic configuration values. . . . .	227
Creating a logical switch or base switch . . . . .	227
Executing a command in a different logical switch context . . . . .	229
Deleting a logical switch . . . . .	230
Adding and moving ports on a logical switch . . . . .	230
Displaying logical switch configuration . . . . .	231
Changing the fabric ID of a logical switch . . . . .	232
Changing a logical switch to a base switch . . . . .	232
Setting up IP addresses for a Virtual Fabric . . . . .	234
Removing an IP address for a Virtual Fabric . . . . .	234
Configuring a logical switch to use XISLs . . . . .	234
Changing the context to a different logical fabric . . . . .	235
Creating a logical fabric using XISLs . . . . .	235

## Chapter 11

### Administering Advanced Zoning

In this chapter . . . . .	237
Special zones . . . . .	237
Zoning overview . . . . .	238
Approaches to zoning . . . . .	239
Zone objects . . . . .	240
Zone aliases . . . . .	241
Zone configurations . . . . .	241
Zoning enforcement . . . . .	242
Considerations for zoning architecture . . . . .	243
Best practices for zoning . . . . .	244
Broadcast zones . . . . .	244
Broadcast zones and Admin Domains . . . . .	244
Broadcast zones and FC-FC routing . . . . .	245
High availability considerations with broadcast zones . . . . .	246
Loop devices and broadcast zones . . . . .	246
Broadcast zones and default zoning mode . . . . .	246

Zone aliases .....	246
Creating an alias .....	247
Adding members to an alias .....	247
Removing members from an alias .....	248
Deleting an alias .....	248
Viewing an alias in the defined configuration .....	249
Zone creation and maintenance .....	249
Creating a zone .....	249
Adding devices (members) to a zone .....	250
Removing devices (members) from a zone .....	250
Deleting a zone .....	251
Viewing a zone in the defined configuration .....	251
Validating a zone .....	251
Default zoning mode .....	252
Setting the default zoning mode .....	253
Viewing the current default zone access mode .....	254
Zone database size .....	254
Zone configurations .....	254
Creating a zone configuration .....	255
Adding zones (members) to a zone configuration .....	255
Removing zones (members) from a zone configuration .....	256
Enabling a zone configuration .....	256
Disabling a zone configuration .....	257
Deleting a zone configuration .....	257
Clearing changes to a configuration .....	258
Viewing all zone configuration information .....	258
Viewing selected zone configuration information .....	259
Viewing the configuration in the effective zone database .....	259
Clearing all zone configurations .....	259
Zone object maintenance .....	260
Copying a zone object .....	260
Deleting a zone object .....	261
Renaming a zone object .....	262
Zone configuration management .....	262
Security and zoning .....	262
Zone merging .....	263
Fabric segmentation and zoning .....	265
Zone merging scenarios .....	265

## Chapter 12

### Traffic Isolation Zoning

In this chapter .....	269
Traffic Isolation Zoning overview .....	269
TI zone failover .....	270
FSPF routing rules and traffic isolation .....	272
Enhanced TI zones .....	274
Illegal configurations with enhanced TI zones .....	275

Traffic Isolation Zoning over FC routers . . . . .	276
TI within an edge fabric . . . . .	277
TI within a backbone fabric . . . . .	278
Limitations of TI zones over FC routers . . . . .	279
General rules for TI zones . . . . .	279
Supported configurations for Traffic Isolation Zoning . . . . .	280
Additional configuration rules for enhanced TI zones . . . . .	281
Trunking with TI zones . . . . .	281
Limitations and restrictions of Traffic Isolation Zoning . . . . .	281
Admin Domain considerations for Traffic Isolation Zoning . . . . .	282
Virtual Fabric considerations for Traffic Isolation Zoning . . . . .	282
Traffic Isolation Zoning over FC routers with Virtual Fabrics . . . . .	284
Creating a TI zone . . . . .	285
Creating a TI zone in a base fabric . . . . .	287
Modifying TI zones . . . . .	288
Changing the state of a TI zone . . . . .	289
Deleting a TI zone . . . . .	290
Displaying TI zones . . . . .	290
Troubleshooting TI zone routing problems . . . . .	291
Setting up TI over FCR (sample procedure) . . . . .	292

## Chapter 13

### Bottleneck Detection

In this chapter . . . . .	297
Bottleneck detection overview . . . . .	297
Types of bottlenecks . . . . .	298
How bottlenecks are reported . . . . .	298
Using alerting parameters to determine whether alerts are generated . . . . .	299
Supported configurations for bottleneck detection . . . . .	300
Limitations of bottleneck detection . . . . .	300
High availability considerations for bottleneck detection . . . . .	300
Upgrade and downgrade considerations for bottleneck detection . . . . .	300
Trunking considerations for bottleneck detection . . . . .	301
Virtual Fabrics considerations for bottleneck detection . . . . .	301
Access Gateway considerations for bottleneck detection . . . . .	301
Advanced bottleneck detection settings . . . . .	301
Enabling bottleneck detection on a switch . . . . .	302
Excluding a port from bottleneck detection . . . . .	303
Displaying bottleneck detection configuration details . . . . .	304
Changing bottleneck parameters . . . . .	305
Displaying bottleneck statistics . . . . .	307

	Disabling bottleneck detection on a switch . . . . .	308
<b>Chapter 14</b>	<b>In-flight Encryption and Compression</b>	
	In this chapter . . . . .	309
	In-flight encryption and compression overview. . . . .	309
	Encryption and compression restrictions. . . . .	310
	How encryption and compression are enabled . . . . .	311
	Authentication and key generation. . . . .	311
	Availability considerations. . . . .	311
	Virtual Fabrics considerations. . . . .	312
	Recommendation for compression. . . . .	312
	Configuring encryption and compression . . . . .	312
	Viewing the encryption and compression configuration. . . . .	313
	Configuring and enabling authentication. . . . .	314
	Configuring encryption . . . . .	315
	Configuring compression. . . . .	316
	Disabling encryption . . . . .	316
	Disabling compression . . . . .	317
	Encryption and compression example. . . . .	317
	Example of enabling encryption and compression on a port .	318
	Example of disabling encryption and compression. . . . .	320
<b>Chapter 15</b>	<b>NPIV</b>	
	In this chapter . . . . .	323
	NPIV overview . . . . .	323
	Upgrade considerations . . . . .	324
	Fixed addressing mode . . . . .	324
	10-bit addressing mode . . . . .	324
	Configuring NPIV . . . . .	325
	Enabling and disabling NPIV . . . . .	326
	Viewing NPIV port configuration information . . . . .	327
	Viewing virtual PID login information . . . . .	328
<b>Chapter 16</b>	<b>Dynamic Fabric Provisioning: Fabric-Assigned WWN</b>	
	In this chapter . . . . .	329
	Introduction to Dynamic Fabric Provisioning using FA-PWWN . . . .	329
	User- and auto-assigned FA-PWWN behavior . . . . .	330
	Checking for duplicate FA-PWWNs . . . . .	330
	Configuring FA-PWWNs . . . . .	330
	Configuring an FA-PWWN for an HBA connected to an Access Gateway . . . . .	331
	Configuring an FA-PWWN for an HBA connected to an edge switch . . . . .	332
	Supported switches and configurations for FA-PWWN. . . . .	333

Configuration upload and download considerations for FA-PWWN	334
Firmware upgrade and downgrade considerations for FA-PWWN	334
Security considerations for FA-PWWN	334
Restrictions of FA-PWWN	335
Access Gateway N_Port failover with FA-PWWN	335

## Chapter 17

### Managing Administrative Domains

In this chapter	337
Administrative Domains overview	337
Admin Domain features	339
Requirements for Admin Domains	339
Admin Domain access levels	339
User-defined Admin Domains	340
System-defined Admin Domains	340
Home Admin Domains and login	342
Admin Domain member types	343
Admin Domains and switch WWNs	344
Admin Domain compatibility, availability, and merging	346
Admin Domain management for physical fabric administrators	346
Setting the default zoning mode for Admin Domains	346
Creating an Admin Domain	347
User assignments to Admin Domains	348
Removing an Admin Domain from a user account	350
Activating an Admin Domain	350
Deactivating an Admin Domain	351
Adding members to an existing Admin Domain	351
Removing members from an Admin Domain	352
Renaming an Admin Domain	352
Deleting an Admin Domain	353
Deleting all user-defined Admin Domains	354
Deleting all user-defined Admin Domains non-disruptively	354
Validating an Admin Domain member list	358
SAN management with Admin Domains	358
CLI commands in an AD context	359
Executing a command in a different AD context	359
Displaying an Admin Domain configuration	359
Switching to a different Admin Domain context	360
Admin Domain interactions with other Fabric OS features	361
Admin Domains, zones, and zone databases	362
Admin Domains and LSAN zones	363
Configuration upload and download in an AD context	364

## Section II

### Licensed Features

## Chapter 18

### Administering Licensing

In this chapter	367
-----------------	-----

Licensing overview . . . . .	367
Brocade 7800 Upgrade license . . . . .	374
ICL licensing . . . . .	374
ICL 1st POD license . . . . .	374
ICL 2nd POD license . . . . .	375
ICL 8-link license . . . . .	375
ICL 16-link license . . . . .	375
Enterprise ICL license . . . . .	375
8G licensing . . . . .	376
Slot-based licensing . . . . .	376
Upgrade and downgrade considerations . . . . .	377
Assigning a license to a slot . . . . .	377
Removing a license from a slot . . . . .	377
10G licensing . . . . .	377
Enabling 10 Gbps operation on an FC port . . . . .	378
Enabling the 10-GbE ports on an FX8-24 blade . . . . .	380
Temporary licenses . . . . .	381
Restrictions on upgrading temporary slot-based licenses . . . . .	381
Date change restriction . . . . .	382
Configupload and download considerations . . . . .	382
Expired licenses . . . . .	382
Universal temporary licenses . . . . .	382
Extending a universal temporary license . . . . .	383
Universal temporary license shelf life . . . . .	383
Viewing installed licenses . . . . .	383
Activating a license . . . . .	383
Adding a licensed feature . . . . .	383
Removing a licensed feature . . . . .	384
Ports on Demand . . . . .	385
Displaying installed licenses . . . . .	386
Activating Ports on Demand . . . . .	387
Dynamic Ports on Demand . . . . .	387
Displaying the port license assignments . . . . .	388
Enabling Dynamic Ports on Demand . . . . .	388
Disabling Dynamic Ports on Demand . . . . .	389
Reserving a port license . . . . .	389
Releasing a port from a POD set . . . . .	390

## Chapter 19

### Inter-chassis Links

In this chapter . . . . .	393
Inter-chassis links . . . . .	393
ICLs for the Brocade DCX 8510 Backbone family . . . . .	394
ICL trunking on the Brocade DCX 8510-8 and DCX 8510-4 . . . . .	395
ICLs for the Brocade DCX Backbone family . . . . .	395
ICL trunking on the Brocade DCX and DCX-4S . . . . .	396



Virtual Fabrics considerations for ICLs .....	396
Supported topologies for ICL connections .....	397
Mesh topology .....	397
Core-edge topology .....	398

## Chapter 20

### Monitoring Fabric Performance

In this chapter .....	399
Advanced Performance Monitoring overview .....	399
Types of monitors .....	399
Restrictions for installing monitors .....	400
Virtual Fabrics considerations for Advanced Performance Monitoring .....	400
Access Gateway considerations for Advanced Performance Monitoring .....	401
End-to-end performance monitoring .....	401
Maximum number of EE monitors .....	401
Supported port configurations for EE monitors .....	402
Adding EE monitors .....	402
Setting a mask for an EE monitor .....	403
Deleting EE monitors .....	404
Displaying EE monitor counters .....	404
Clearing EE monitor counters .....	405
Frame monitoring .....	406
Creating frame types to be monitored .....	406
Deleting frame types .....	407
Adding frame monitors to a port .....	408
Removing frame monitors from a port .....	408
Saving frame monitor configuration .....	408
Displaying frame monitors .....	409
Clearing frame monitor counters .....	409
Top Talker monitors .....	410
Top Talker monitors and FC-FC routing .....	411
Limitations of Top Talker monitors .....	412
Adding a Top Talker monitor to a port (port mode) .....	413
Adding Top Talker monitors on all switches in the fabric (fabric mode) .....	413
Displaying the top n bandwidth-using flows on a port (port mode) .....	413
Displaying top talking flows for a given domain ID (fabric mode) .....	414
Deleting a Top Talker monitor on a port (port mode) .....	414
Deleting all fabric mode Top Talker monitors .....	415
Trunk monitoring .....	415
Saving and restoring monitor configurations .....	415
Performance data collection .....	416

## Chapter 21

### Optimizing Fabric Behavior

In this chapter . . . . .	417
Adaptive Networking overview . . . . .	417
Ingress Rate Limiting . . . . .	418
Limiting traffic from a particular device . . . . .	419
Disabling ingress rate limiting . . . . .	419
QoS: SID/DID traffic prioritization . . . . .	419
License requirements for SID/DID prioritization . . . . .	420
CS_CTL-based frame prioritization . . . . .	420
Supported configurations for CS_CTL-based frame prioritization . . . . .	421
High availability considerations for CS_CTL-based frame prioritization . . . . .	421
Enabling CS_CTL-based frame prioritization . . . . .	421
Disabling CS_CTL-based frame prioritization . . . . .	421
QoS zone-based traffic prioritization . . . . .	421
Trunking considerations before you install the Adaptive Networking license . . . . .	422
Manually disabling QoS on trunked ports . . . . .	422
QoS zones . . . . .	424
QoS on E_Ports . . . . .	425
QoS over FC routers . . . . .	426
Virtual Fabrics considerations for QoS zone-based traffic prioritization . . . . .	427
High availability considerations for QoS zone-based traffic prioritization . . . . .	428
Supported configurations for QoS zone-based traffic prioritization . . . . .	428
Limitations and restrictions for QoS zone-based traffic prioritization . . . . .	428
Setting QoS zone-based traffic prioritization . . . . .	429
Setting QoS zone-based traffic prioritization over FC routers . . . .	431
Disabling QoS zone-based traffic prioritization . . . . .	431

## Chapter 22

### Managing Trunking Connections

In this chapter . . . . .	433
Trunking overview . . . . .	433
Types of trunking . . . . .	434
Masterless trunking . . . . .	434
License requirements for trunking . . . . .	435
Port groups for trunking . . . . .	435
Requirements for trunk groups . . . . .	435
Supported configurations for trunking . . . . .	436
High availability support for trunking . . . . .	436

Supported platforms for trunking. . . . .	436
Recommendations for trunking groups. . . . .	437
Configuring trunk groups . . . . .	437
Enabling trunking on a port or switch . . . . .	438
Disabling trunking on a port or switch. . . . .	438
Displaying trunking information . . . . .	439
ISL trunking over long distance fabrics . . . . .	440
EX_Port trunking . . . . .	440
Masterless EX_Port trunking. . . . .	441
Supported configurations and platforms for EX_Port trunking	441
Configuring EX_Port trunking . . . . .	442
Displaying EX_Port trunking information . . . . .	442
F_Port trunking . . . . .	442
F_Port trunking for Access Gateway . . . . .	443
Requirements for F_Port trunking on an Access Gateway . . . . .	444
F_Port trunking for Brocade adapters . . . . .	444
F_Port trunking considerations. . . . .	444
Trunk Area and Admin Domains . . . . .	446
F_Port trunking in Virtual Fabrics . . . . .	447
Configuring F_Port trunking for Access Gateway . . . . .	447
Configuring F_Port trunking for Brocade adapters. . . . .	448
Displaying F_Port trunking information . . . . .	448
Disabling F_Port trunking. . . . .	449
Enabling the DCC policy on a trunk area. . . . .	449

## Chapter 23

### Managing Long Distance Fabrics

In this chapter . . . . .	451
Long distance fabrics overview . . . . .	451
Extended Fabrics device limitations . . . . .	452
Long distance link modes. . . . .	452
Configuring an extended ISL . . . . .	453
Enabling long distance when connecting to TDM devices . . . . .	454
Buffer credit management . . . . .	455
Buffer-to-buffer flow control . . . . .	455
Optimal buffer credit allocation . . . . .	456
Fibre Channel gigabit values reference definition. . . . .	457
Allocating buffer credits based on full-size frames . . . . .	457
Allocating buffer credits based on average-size frames. . . . .	459
Allocating buffer credits for F_Ports . . . . .	460
Displaying the remaining buffers in a port group . . . . .	460
Buffer credits for each switch model . . . . .	461
Maximum configurable distances for Extended Fabrics. . . . .	462
Buffer credit recovery . . . . .	463

## Chapter 24

## Using FC-FC Routing to Connect Fabrics

In this chapter . . . . .	465
FC-FC routing overview . . . . .	465
License requirements for FC-FC routing. . . . .	466
Supported platforms for FC-FC routing. . . . .	466
Supported configurations for FC-FC routing. . . . .	467
Unsupported configurations for Network OS connectivity . . .	467
Fibre Channel routing concepts. . . . .	468
Proxy devices . . . . .	471
FC-FC routing topologies . . . . .	472
Phantom domains . . . . .	473
Setting up FC-FC routing. . . . .	475
Verifying the setup for FC-FC routing . . . . .	475
Backbone fabric IDs . . . . .	477
Assigning backbone fabric IDs . . . . .	477
FCIP tunnel configuration . . . . .	478
Inter-fabric link configuration . . . . .	478
Configuring an IFL for both edge and backbone connections	478
FC router port cost configuration . . . . .	482
Port cost considerations . . . . .	483
Setting router port cost for an EX_Port. . . . .	483
EX_Port frame trunking configuration . . . . .	484
LSAN zone configuration . . . . .	485
Use of Admin Domains with LSAN zones and FC-FC routing	485
Zone definition and naming . . . . .	485
LSAN zones and fabric-to-fabric communications. . . . .	486
Controlling device communication with the LSAN. . . . .	486
Configuring backbone fabrics for interconnectivity. . . . .	489
Setting the maximum LSAN count . . . . .	489
HA and downgrade considerations for LSAN zones . . . . .	489
LSAN zone policies using LSAN tagging. . . . .	490
LSAN zone binding. . . . .	493
Proxy PID configuration. . . . .	498
Fabric parameter considerations. . . . .	498
Inter-fabric broadcast frames. . . . .	499
Displaying the current broadcast configuration. . . . .	499
Enabling broadcast frame forwarding . . . . .	499
Disabling broadcast frame forwarding . . . . .	499
Resource monitoring. . . . .	500
FC-FC routing and Virtual Fabrics. . . . .	501
Logical switch configuration for FC routing . . . . .	502
Backbone-to-edge routing with Virtual Fabrics . . . . .	503
Upgrade and downgrade considerations for FC-FC routing . . . . .	504
How replacing port blades affects EX_Port configuration. . .	504
Displaying the range of output ports connected to xlate domains	505

<b>Appendix A</b>	<b>Interoperation of Fabric OS and M-EOS Fabrics Using FC Router</b>	
	In this appendix . . . . .	507
	Interoperability overview . . . . .	507
	Release Compatibility . . . . .	507
	Features of Connected SANs . . . . .	509
	Establishing interoperability . . . . .	509
	Fabric configurations for interconnectivity . . . . .	510
	Connectivity modes . . . . .	510
	Configuring the FC router . . . . .	511
	Configuring LSAN zones in the M-EOS fabric . . . . .	512
	Correcting errors if LSAN devices appear in only one of the fabrics. . . . .	513
	Completing the configuration . . . . .	513
<b>Appendix B</b>	<b>Port Indexing</b>	
<b>Appendix C</b>	<b>FIPS Support</b>	
	In this appendix . . . . .	521
	FIPS overview . . . . .	521
	Zeroization functions . . . . .	521
	Power-on self tests . . . . .	522
	Conditional tests . . . . .	522
	FIPS mode configuration . . . . .	523
	LDAP in FIPS mode . . . . .	524
	LDAP certificates for FIPS mode . . . . .	526
	Preparing the switch for FIPS . . . . .	527
	Overview of steps . . . . .	527
	Enabling FIPS mode . . . . .	528
	Zeroizing for FIPS . . . . .	530
	Displaying FIPS configuration . . . . .	530
<b>Appendix D</b>	<b>Hexadecimal Conversion</b>	
	Hexadecimal overview . . . . .	531
	Example conversion of the hexadecimal triplet 0x616000 . . . . .	531
	<b>Index</b>	



# Figures

---

<b>Figure 1</b>	Well-known addresses . . . . .	3
<b>Figure 2</b>	Identifying the blades . . . . .	51
<b>Figure 3</b>	Blade swap with Virtual Fabrics during the swap . . . . .	52
<b>Figure 4</b>	Blade swap with Virtual Fabrics after the swap . . . . .	52
<b>Figure 5</b>	Principal ISLs . . . . .	64
<b>Figure 6</b>	New switch added to existing fabric . . . . .	66
<b>Figure 7</b>	Virtual channels on a QoS-enabled ISL . . . . .	68
<b>Figure 8</b>	Gateway link merging SANs . . . . .	69
<b>Figure 9</b>	Single host and target . . . . .	79
<b>Figure 10</b>	Windows 2000 VSA configuration . . . . .	101
<b>Figure 11</b>	Example of a Brocade DCT file . . . . .	108
<b>Figure 12</b>	Example of the dictiona.dcm file . . . . .	108
<b>Figure 13</b>	DH-CHAP authentication . . . . .	144
<b>Figure 14</b>	Protected endpoints configuration . . . . .	167
<b>Figure 15</b>	Gateway tunnel configuration . . . . .	168
<b>Figure 16</b>	Endpoint-to-gateway tunnel configuration . . . . .	168
<b>Figure 17</b>	Switch before and after enabling Virtual Fabrics . . . . .	212
<b>Figure 18</b>	Switch before and after creating logical switches . . . . .	213
<b>Figure 19</b>	Fabric IDs assigned to logical switches . . . . .	214
<b>Figure 20</b>	Assigning ports to logical switches . . . . .	214
<b>Figure 21</b>	Logical switches connected to devices and non-Virtual Fabrics switch . . . . .	216
<b>Figure 22</b>	Logical switches in a single chassis belong to separate fabrics . . . . .	216
<b>Figure 23</b>	Logical switches connected to other logical switches through physical ISLs . . . . .	217
<b>Figure 24</b>	Logical switches connected to form logical fabrics . . . . .	217
<b>Figure 25</b>	Base switches connected by an XISL . . . . .	218
<b>Figure 26</b>	Logical ISLs connecting logical switches . . . . .	219
<b>Figure 27</b>	Logical fabric using ISLs and XISLs . . . . .	219
<b>Figure 28</b>	Example of logical fabrics in multiple chassis and XISLs . . . . .	235
<b>Figure 29</b>	Zoning example . . . . .	239
<b>Figure 30</b>	Broadcast zones and Admin Domains . . . . .	245
<b>Figure 31</b>	Traffic Isolation zone creating a dedicated path through the fabric . . . . .	270
<b>Figure 32</b>	Fabric incorrectly configured for TI zone with failover disabled . . . . .	272
<b>Figure 33</b>	Dedicated path is the only shortest path . . . . .	273
<b>Figure 34</b>	Dedicated path is not the shortest path . . . . .	274
<b>Figure 35</b>	Enhanced TI zones . . . . .	274

<b>Figure 36</b>	Illegal ETIZ configuration: two paths from one port to two devices on the same remote domain . . . . .	275
<b>Figure 37</b>	Illegal ETIZ configuration: two paths from one port . . . . .	276
<b>Figure 38</b>	Traffic Isolation Zoning over FCR . . . . .	277
<b>Figure 39</b>	TI zone in an edge fabric . . . . .	277
<b>Figure 40</b>	TI zone in a backbone fabric . . . . .	278
<b>Figure 41</b>	TI zone misconfiguration . . . . .	280
<b>Figure 42</b>	Dedicated path with Virtual Fabrics . . . . .	283
<b>Figure 43</b>	Creating a TI zone in a logical fabric . . . . .	283
<b>Figure 44</b>	Creating a TI zone in a base fabric . . . . .	283
<b>Figure 45</b>	Example configuration for TI zones over FC routers in logical fabrics . . . . .	284
<b>Figure 46</b>	Logical representation of TI zones over FC routers in logical fabrics . . . . .	285
<b>Figure 47</b>	TI over FCR example . . . . .	292
<b>Figure 48</b>	Affected seconds for bottleneck detection . . . . .	299
<b>Figure 49</b>	Encryption and compression on 16 Gbps ISLs . . . . .	310
<b>Figure 50</b>	Fabric-assigned port world wide name provisioning scenarios . . . . .	331
<b>Figure 51</b>	Fabric with two Admin Domains . . . . .	338
<b>Figure 52</b>	Filtered fabric views when using Admin Domains . . . . .	338
<b>Figure 53</b>	Fabric with ADO and AD255 . . . . .	342
<b>Figure 54</b>	Fabric showing switch and device WWNs . . . . .	345
<b>Figure 55</b>	Filtered fabric views showing converted switch WWNs . . . . .	345
<b>Figure 56</b>	ADO and two user-defined Admin Domains, AD1 and AD2 . . . . .	356
<b>Figure 57</b>	ADO with three zones . . . . .	356
<b>Figure 58</b>	Minimum configuration for 64 Gbps ICLs . . . . .	394
<b>Figure 59</b>	DCX-4S allowed ICL connections . . . . .	396
<b>Figure 60</b>	ICL triangular topology with Brocade DCX 8510-8 chassis . . . . .	397
<b>Figure 61</b>	64 Gbps ICL core-edge topology . . . . .	398
<b>Figure 62</b>	Setting end-to-end monitors on a port . . . . .	402
<b>Figure 63</b>	Mask positions for end-to-end monitors . . . . .	404
<b>Figure 64</b>	Fabric mode Top Talker monitors on FC router do not monitor any flows . . . .	412
<b>Figure 65</b>	Fabric mode Top Talker monitors on FC router monitor flows over the E_Port .	412
<b>Figure 66</b>	QoS traffic prioritization . . . . .	425
<b>Figure 67</b>	QoS with E_Ports enabled . . . . .	426
<b>Figure 68</b>	Traffic prioritization in a logical fabric . . . . .	427
<b>Figure 69</b>	Trunk group configuration for the Brocade 5100 . . . . .	435
<b>Figure 70</b>	Switch in Access Gateway mode without F_Port trunking . . . . .	443
<b>Figure 71</b>	Switch in Access Gateway mode with F_Port masterless trunking . . . . .	443
<b>Figure 72</b>	A metaSAN with inter-fabric links . . . . .	468
<b>Figure 73</b>	A metaSAN with edge-to-edge and backbone fabrics and LSAN zones . . . . .	469
<b>Figure 74</b>	Edge SANs connected through a backbone fabric . . . . .	471
<b>Figure 75</b>	MetaSAN with imported devices . . . . .	472
<b>Figure 76</b>	Sample topology (physical topology) . . . . .	473



<b>Figure 77</b>	EX_Port phantom switch topology . . . . .	474
<b>Figure 78</b>	Example of setting up Speed LSAN tag. . . . .	491
<b>Figure 79</b>	LSAN zone binding . . . . .	494
<b>Figure 80</b>	EX_Ports in a base switch . . . . .	502
<b>Figure 81</b>	Logical representation of EX_Ports in a base switch. . . . .	503
<b>Figure 82</b>	Backbone-to-edge routing across base switch using FC router in legacy mode	504



# Tables

---

<b>Table 1</b>	Daemons that are automatically restarted . . . . .	13
<b>Table 2</b>	Terminal port parameters . . . . .	16
<b>Table 3</b>	Help topic contents . . . . .	18
<b>Table 4</b>	fabricShow fields . . . . .	29
<b>Table 5</b>	Core and CP blade terminology and platform support . . . . .	44
<b>Table 6</b>	Port blade terminology, numbering, and platform support . . . . .	45
<b>Table 7</b>	Blade compatibility within Brocade Backbone families . . . . .	48
<b>Table 8</b>	Duplicate PWWN behavior: Existing login takes precedence over second login	60
<b>Table 9</b>	Duplicate PWWN behavior: Second login overrides existing login . . . . .	61
<b>Table 10</b>	Combinations of routing policy and IOD with Lossless DLS enabled . . . . .	76
<b>Table 11</b>	Default Fabric OS roles . . . . .	82
<b>Table 12</b>	Permission types . . . . .	83
<b>Table 13</b>	Maximum number of simultaneous sessions . . . . .	84
<b>Table 14</b>	Default local user accounts . . . . .	86
<b>Table 15</b>	Authentication configuration options . . . . .	98
<b>Table 16</b>	Syntax for VSA-based account roles . . . . .	100
<b>Table 17</b>	Entries in dictionary.brocade file . . . . .	101
<b>Table 18</b>	Secure protocol support . . . . .	115
<b>Table 19</b>	Items needed to deploy secure protocols . . . . .	116
<b>Table 20</b>	Main security scenarios . . . . .	116
<b>Table 21</b>	SSL certificate files . . . . .	121
<b>Table 22</b>	Blocked listener applications . . . . .	129
<b>Table 23</b>	Access defaults . . . . .	130
<b>Table 24</b>	Port information . . . . .	130
<b>Table 25</b>	Valid methods for specifying policy members . . . . .	132
<b>Table 26</b>	FCS policy states . . . . .	135
<b>Table 27</b>	FCS switch operations . . . . .	136
<b>Table 28</b>	Distribution policy states . . . . .	138
<b>Table 29</b>	DCC policy states . . . . .	139
<b>Table 30</b>	DCC policy behavior with FA-PWWN when created using lockdown support . .	141
<b>Table 31</b>	DCC policy behavior when created manually with PWWN . . . . .	142
<b>Table 32</b>	SCC policy states . . . . .	142
<b>Table 33</b>	FCAP certificate files . . . . .	151
<b>Table 34</b>	Supported services . . . . .	156
<b>Table 35</b>	Implicit IP Filter rules . . . . .	157
<b>Table 36</b>	Default IP policy rules . . . . .	158

<b>Table 37</b>	Interaction between fabric-wide consistency policy and distribution settings .	161
<b>Table 38</b>	Supported policy databases . . . . .	161
<b>Table 39</b>	Fabric-wide consistency policy settings . . . . .	163
<b>Table 40</b>	Merging fabrics with matching fabric-wide consistency policies. . . . .	165
<b>Table 41</b>	Examples of strict fabric merges . . . . .	166
<b>Table 42</b>	Fabric merges with tolerant and absent combinations . . . . .	166
<b>Table 43</b>	Algorithms and associated authentication policies . . . . .	169
<b>Table 44</b>	CLI commands to display or modify switch configuration information . . . . .	183
<b>Table 45</b>	Brocade configuration and connection. . . . .	189
<b>Table 46</b>	Backbone HA sync states. . . . .	193
<b>Table 47</b>	Blade and port types supported on logical switches . . . . .	222
<b>Table 48</b>	Virtual Fabrics interaction with Fabric OS features . . . . .	223
<b>Table 49</b>	Maximum number of logical switches per chassis. . . . .	224
<b>Table 50</b>	Approaches to fabric-based zoning. . . . .	239
<b>Table 51</b>	Considerations for zoning architecture . . . . .	243
<b>Table 52</b>	Zone merging scenarios: Defined and effective configurations . . . . .	265
<b>Table 53</b>	Zone merging scenarios: Different content . . . . .	266
<b>Table 54</b>	Zone merging scenarios: Different names . . . . .	266
<b>Table 55</b>	Zone merging scenarios: TI zones . . . . .	267
<b>Table 56</b>	Zone merging scenarios: Default access mode . . . . .	267
<b>Table 57</b>	Zone merging scenarios: Mixed Fabric OS versions. . . . .	268
<b>Table 58</b>	Traffic behavior when failover is enabled or disabled in TI zones . . . . .	271
<b>Table 59</b>	Example ISL connections . . . . .	317
<b>Table 60</b>	Number of supported NPIV devices . . . . .	324
<b>Table 61</b>	AD user types . . . . .	340
<b>Table 62</b>	Ports and devices in CLI output. . . . .	359
<b>Table 63</b>	Admin Domain interaction with Fabric OS features . . . . .	361
<b>Table 64</b>	Configuration upload and download scenarios in an AD context . . . . .	364
<b>Table 65</b>	Available Brocade licenses . . . . .	368
<b>Table 66</b>	License requirements and location name by feature . . . . .	371
<b>Table 67</b>	Base to Upgrade license comparison . . . . .	374
<b>Table 68</b>	List of available ports when implementing PODs . . . . .	386
<b>Table 69</b>	Number of logical switches that support performance monitors . . . . .	400
<b>Table 70</b>	Maximum number of frame monitors and offsets per port. . . . .	406
<b>Table 71</b>	Predefined values at offset 0. . . . .	407
<b>Table 72</b>	Comparison between CS_CTL-based and QoS zone-based prioritization. . . . .	420
<b>Table 73</b>	Virtual channels assigned to QoS priority for frame prioritization. . . . .	420
<b>Table 74</b>	Virtual channels assigned to QoS priority for zone-based prioritization . . . . .	422
<b>Table 75</b>	Trunking over distance for the Backbones. . . . .	440
<b>Table 76</b>	F_Port masterless considerations. . . . .	444
<b>Table 77</b>	PWWN format for F_Port and N_Port trunk ports. . . . .	446
<b>Table 78</b>	Fibre Channel data frames . . . . .	457

<b>Table 79</b>	Buffer credits .....	461
<b>Table 80</b>	Configurable distances for Extended Fabrics.....	462
<b>Table 81</b>	LSAN information stored in FC routers, with and without LSAN zone binding .	495
<b>Table 82</b>	Fabric OS and M-EOSc interoperability compatibility matrix.....	508
<b>Table 83</b>	Fabric OS and M-EOSn interoperability compatibility matrix.....	508
<b>Table 84</b>	Values of portCfgEXPort -m option .....	510
<b>Table 85</b>	Zeroization behavior.....	521
<b>Table 86</b>	FIPS mode restrictions.....	523
<b>Table 87</b>	FIPS and non-FIPS modes of operation .....	524
<b>Table 88</b>	Active Directory keys to modify .....	525
<b>Table 89</b>	Decimal to hexadecimal conversion table .....	532



# About This Document

---

## In this chapter

- [How this document is organized](#) ..... xxxiii
- [Supported hardware and software](#)..... xxxiv
- [What's new in this document](#)..... xxxv
- [Document conventions](#) ..... xxxvi
- [Notice to the reader](#) ..... xxxvii
- [Additional information](#)..... xxxviii
- [Getting technical help](#) ..... xxxviii
- [Document feedback](#) ..... xxxix

## How this document is organized

The document is divided into two sections; the first, “Standard Features,” contains the following topics:

- [Chapter 1, “Understanding Fibre Channel Services,”](#) provides information on the Fibre Channel services on Brocade switches.
- [Chapter 2, “Performing Basic Configuration Tasks,”](#) gives a brief overview of Fabric OS, explains the Fabric OS CLI Help feature, and provides typical connection and configuration procedures.
- [Chapter 3, “Performing Advanced Configuration Tasks,”](#) provides advanced connection and configuration procedures.
- [Chapter 4, “Routing Traffic,”](#) provides information and procedures for using switch routing features.
- [Chapter 5, “Managing User Accounts,”](#) provides information and procedures on managing authentication and user accounts for the switch management channel.
- [Chapter 6, “Configuring Protocols,”](#) provides procedures for basic password and user account management.
- [Chapter 7, “Configuring Security Policies,”](#) provides information and procedures for configuring ACL policies for FC port and switch binding and managing the fabric-wide consistency policy.
- [Chapter 8, “Maintaining the Switch Configuration File,”](#) provides procedures for maintaining and backing up your switch configurations.
- [Chapter 9, “Installing and Maintaining Firmware,”](#) provides preparations and procedures for performing firmware downloads.
- [Chapter 10, “Managing Virtual Fabrics,”](#) describes the concepts and provides procedures for using Virtual Fabrics.

- [Chapter 11, “Administering Advanced Zoning,”](#) provides procedures for use of the Brocade Advanced Zoning feature.
- [Chapter 12, “Traffic Isolation Zoning,”](#) provides concepts and procedures for use of Traffic Isolation Zones within a fabric.
- [Chapter 13, “Bottleneck Detection,”](#) describes how you can detect and configure alert thresholds for latency and congestion bottlenecks in the fabric.
- [Chapter 14, “In-flight Encryption and Compression,”](#) describes concepts and provide procedures for configuring encryption and compression on 16 Gbps ports that connect to other switches using ISLs.
- [Chapter 15, “NPIV,”](#) provides procedures for enabling and configuring N-Port ID Virtualization (NPIV).
- [Chapter 16, “Dynamic Fabric Provisioning: Fabric-Assigned WWN,”](#) describes the Dynamic Fabric Provisioning feature using the fabric-assigned port World Wide Name (FA-PWWN).
- [Chapter 17, “Managing Administrative Domains,”](#) describes the concepts and provides procedures for using administrative domains.

The second section, “Licensed Features,” contains the following topics:

- [Chapter 18, “Administering Licensing,”](#) provides information about Brocade licenses and their implementation on SAN switches.
- [Chapter 19, “Inter-chassis Links,”](#) describes the two different types of ICLs between Brocade Backbones.
- [Chapter 20, “Monitoring Fabric Performance,”](#) provides procedures for use of the Brocade Advanced Performance Monitoring licensed feature.
- [Chapter 21, “Optimizing Fabric Behavior,”](#) provides procedures for use of the Brocade Adaptive Networking suite of tools, including Traffic Isolation, QoS Ingress Rate Limiting, and QoS SID/DID Traffic Prioritization.
- [Chapter 22, “Managing Trunking Connections,”](#) provides procedures for use of the Brocade ISL Trunking licensed feature.
- [Chapter 23, “Managing Long Distance Fabrics,”](#) provides procedures for use of the Brocade Extended Fabrics licensed feature.
- [Chapter 24, “Using FC-FC Routing to Connect Fabrics,”](#) provides information for setting up and using the FC-FC Routing Service.
- The appendices provide special procedures or information for Fabric OS.

## Supported hardware and software

In those instances in which procedures or parts of procedures documented here apply to some switches but not to others, this guide identifies exactly which switches are supported and which are not.

Although many different software and hardware configurations are tested and supported by Brocade Communications Systems, Inc. for Fabric OS v7.0.1, documenting all possible configurations and scenarios is beyond the scope of this document.



The following hardware platforms are supported by this release of Fabric OS:

- Fixed-port switches:
  - Brocade 300 switch
  - Brocade 5100 switch
  - Brocade 5300 switch
  - Brocade 5410 embedded switch
  - Brocade 5424 embedded switch
  - Brocade 5450 embedded switch
  - Brocade 5460 embedded switch
  - Brocade 5470 embedded switch
  - Brocade 5480 embedded switch
  - Brocade 6505 switch
  - Brocade 6510 switch
  - Brocade 7800 extension switch
  - Brocade 8000 FCoE switch
  - Brocade VA-40FC
  - Brocade Encryption Switch
- Brocade DCX Backbone family:
  - Brocade DCX
  - Brocade DCX-4S
- Brocade DCX 8510 Backbone family:
  - Brocade DCX 8510-4
  - Brocade DCX 8510-8

## What's new in this document

Information that was modified:

- Support for new platforms:
  - Brocade 6505 switch
  - FC8-32E port blade
  - FC8-48E port blade
- Added information about duplication PWWN detection. (Refer to [“Duplicate Port World Wide Name”](#) on page 13 and [“Configuring FLOGI-time handling of duplicate PWWN”](#) on page 60.)
- Added Enterprise ICL license for connecting more than four Brocade DCX 8510 Backbones with ICLs. (Refer to [Chapter 18, “Administering Licensing”](#) on page 367.)
- Connectivity between Fabric OS and Brocade Network OS fabrics through FC-FC routing. (Refer to [Chapter 24, “Using FC-FC Routing to Connect Fabrics,”](#) on page 465.)
- Moved the ICL and ICL trunking information to a new chapter, [Chapter 19, “Inter-chassis Links,”](#) on page 393.

# Document conventions

This section describes text formatting conventions and important notice formats used in this document.

## Text formatting

The narrative-text formatting conventions that are used are as follows:

<b>bold text</b>	Identifies command names Identifies the names of user-manipulated GUI elements Identifies keywords and operands Identifies text to enter at the GUI or CLI
<i>italic text</i>	Provides emphasis Identifies variables Identifies paths and Internet addresses Identifies document titles
<code>code text</code>	Identifies CLI output Identifies command syntax examples

For readability, command names in the narrative portions of this guide are presented in mixed lettercase: for example, switchShow. In actual examples, command lettercase is often all lowercase. Otherwise, this manual specifically notes those cases in which a command is case sensitive.

## Command syntax conventions

Command syntax in this manual follows these conventions:

command	Commands are printed in bold.
--option, option	Command options are printed in bold.
-argument, arg	Arguments.
[ ]	Optional element.
variable	Variables are printed in italics. In the help pages, values are <u>underlined</u> or enclosed in angled brackets < >.
...	Repeat the previous element, for example “member[;member...]”
value	Fixed values following arguments are printed in plain font. For example, --show WWN
	Boolean. Elements are exclusive. Example: --show -mode egress   ingress

## Notes, cautions, and warnings

The following notices and statements are used in this manual. They are listed below in order of increasing severity of potential hazards.

---

**NOTE**

A note provides a tip, guidance or advice, emphasizes important information, or provides a reference to related information.

---

**ATTENTION**

An Attention statement indicates potential damage to hardware or data.

---

**CAUTION**

A Caution statement alerts you to situations that can be potentially hazardous to you or cause damage to hardware, firmware, software, or data.

---

**DANGER**

A Danger statement indicates conditions or situations that can be potentially lethal or extremely hazardous to you. Safety labels are also attached directly to products to warn of these conditions or situations.

---

## Key terms

For definitions specific to Brocade and Fibre Channel, see the *Brocade Glossary*.

For definitions of SAN-specific terms, visit the Storage Networking Industry Association online dictionary at:

<http://www.snia.org/education/dictionary>

## Notice to the reader

This document may contain references to the trademarks of the following corporations. These trademarks are the properties of their respective companies and corporations.

These references are made for informational purposes only.

Corporation	Referenced Trademarks and Products
Microsoft Corporation	Windows, Windows NT, Internet Explorer
Mozilla Corporation	Mozilla, Firefox
Netscape Communications Corporation	Netscape
Red Hat, Inc.	Red Hat, Red Hat Network, Maximum RPM, Linux Undercover
Sun Microsystems, Inc.	Sun, Solaris

## Additional information

This section lists additional Brocade and industry-specific documentation that you might find helpful.

### Brocade resources

To get up-to-the-minute information, go to <http://my.brocade.com> and register at no cost for a user ID and password.

For practical discussions about SAN design, implementation, and maintenance, you can obtain *Building SANs with Brocade Fabric Switches* through:

<http://www.amazon.com>

For additional Brocade documentation, visit the Brocade SAN Info Center and click the Resource Library location:

<http://www.brocade.com>

Release notes are available on the My Brocade website and are also bundled with the Fabric OS firmware.

### Other industry resources

For additional resource information, visit the Technical Committee T11 website. This website provides interface standards for high-performance and mass storage applications for Fibre Channel, storage management, and other applications:

<http://www.t11.org>

For information about the Fibre Channel industry, visit the Fibre Channel Industry Association website:

<http://www.fibrechannel.org>

## Getting technical help

Contact your switch support supplier for hardware, firmware, and software support, including product repairs and part ordering. To expedite your call, have the following information available:

#### 1. General Information

- Switch model
- Switch operating system version
- Error numbers and messages received
- **supportSave** command output
- Detailed description of the problem, including the switch or fabric behavior immediately following the problem, and specific questions
- Description of any troubleshooting steps already performed and the results
- Serial console and Telnet session logs

- syslog message logs

## 2. Switch Serial Number

The switch serial number and corresponding bar code are provided on the serial number label, as illustrated below.:

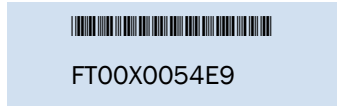

The serial number label is located as follows:

- *Brocade 5424* – On the bottom of the switch module.
- *Brocade 300, 5100, and 5300* – On the switch ID pull-out tab located on the bottom of the port side of the switch.
- *Brocade 6510* – On the switch ID pull-out tab located inside the chassis on the port side on the left.
- *Brocade 7800 and 8000* – On the bottom of the chassis.
- *Brocade DCX-4S and DCX 8510-4* – On the nonport side of the chassis, on the lower left side.
- *Brocade DCX and DCX 8510-8* – On the port side of the chassis, on the lower right side and directly above the cable management comb.

## 3. World Wide Name (WWN)

Use the **wwn** command to display the switch WWN.

If you cannot use the **wwn** command because the switch is inoperable, you can get the WWN from the same place as the serial number, except for the Brocade DCX enterprise class platform. For the Brocade DCX enterprise class platform, access the numbers on the WWN cards by removing the Brocade logo plate at the top of the nonport side of the chassis.

For the Brocade 5424 embedded switch: Provide the license ID. Use the **licenseIdShow** command to display the WWN.

# Document feedback

Quality is our first concern at Brocade and we have made every effort to ensure the accuracy and completeness of this document. However, if you find an error or an omission, or you think that a topic needs further development, we want to hear from you. Forward your feedback to:

[documentation@brocade.com](mailto:documentation@brocade.com)

Provide the title and version number of the document and as much detail as possible about your comment, including the topic heading and page number and your suggestions for improvement.



# Standard Features

This section describes standard Fabric OS features, and includes the following chapters:

- [Chapter 1, “Understanding Fibre Channel Services”](#)
- [Chapter 2, “Performing Basic Configuration Tasks”](#)
- [Chapter 3, “Performing Advanced Configuration Tasks”](#)
- [Chapter 4, “Routing Traffic”](#)
- [Chapter 5, “Managing User Accounts”](#)
- [Chapter 6, “Configuring Protocols”](#)
- [Chapter 7, “Configuring Security Policies”](#)
- [Chapter 8, “Maintaining the Switch Configuration File”](#)
- [Chapter 9, “Installing and Maintaining Firmware”](#)
- [Chapter 10, “Managing Virtual Fabrics”](#)
- [Chapter 11, “Administering Advanced Zoning”](#)
- [Chapter 12, “Traffic Isolation Zoning”](#)
- [Chapter 13, “Bottleneck Detection”](#)
- [Chapter 14, “In-flight Encryption and Compression”](#)
- [Chapter 15, “NPIV”](#)
- [Chapter 16, “Dynamic Fabric Provisioning: Fabric-Assigned WWN”](#)
- [Chapter 17, “Managing Administrative Domains”](#)





# Understanding Fibre Channel Services

## In this chapter

- Fibre Channel services overview ..... 3
- Management server ..... 4
- Platform services ..... 4
- Management server database ..... 6
- Topology discovery ..... 9
- Device login ..... 10
- High availability of daemon processes ..... 13

## Fibre Channel services overview

Fibre Channel services define service functions that reside at well-known addresses, as illustrated in [Figure 1](#). A *well-known address* is a reserved three-byte address for each service. Services are provided to either nodes or management applications in the fabric.

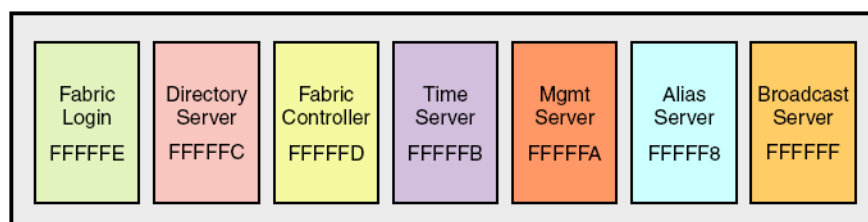

**FIGURE 1** Well-known addresses

**Fabric Login** – The Fabric Login server assigns a fabric address to a fabric node, which allows it to communicate with services on the switch or other nodes in the fabric. The fabric address is a 24-bit address (0x000000) containing three 3-byte nodes. Reading from left to right, the first node (0x000000) represents the domain ID, the second node (0x000000) the port area number of the port where the node is attached, and the third node (0x000000) the arbitrated loop physical address (AL\_PA), if applicable.

**Directory server** – The directory server or name server registers fabric and public nodes and conducts queries to discover other devices in the fabric.

**Fabric controller** – The fabric controller provides State Change Notifications (SCNs) to registered nodes when a change in the fabric topology occurs.

**Time server** – The time server sends the time to the member switches in the fabric from either the principal switch or, if configured, the primary fabric configuration server (FCS) switch. Refer to [Chapter 7, “Configuring Security Policies,”](#) for additional information on FCS policies.

# 1 Management server

Management server — The management server provides a single point for managing the fabric. This is the only service that users can configure.

Alias server — The alias server keeps a group of nodes registered as one name to handle multicast groups.

Broadcast server — The broadcast server is optional. When frames are transmitted to this address, they are broadcast to all operational N\_ and NL\_Ports.

When registration and query frames are sent to a well-known address, a different protocol service, Fibre Channel Common Transport (FC-CT), is used. This protocol provides a simple, consistent format and behavior when a service provider is accessed for registration and query purposes.

## Management server

The Brocade Fabric OS management server (MS) allows a SAN management application to retrieve information and administer interconnected switches, servers, and storage devices. The management server assists in the autodiscovery of switch-based fabrics and their associated topologies.

A client of the management server can find basic information about the switches in the fabric and use this information to construct topology relationships. The management server also allows you to obtain certain switch attributes and, in some cases, modify them. For example, logical names identifying switches can be registered with the management server.

The management server provides several advantages for managing a Fibre Channel fabric:

- It is accessed by an external Fibre Channel node at the well-known address *FFFFFAh*, so an application can access information about the entire fabric management with minimal knowledge of the existing configuration.
- It is replicated on every Brocade switch within a fabric.
- It provides an unzoned view of the overall fabric configuration. This fabric topology view exposes the internal configuration of a fabric for management purposes; it contains interconnect information about switches and devices connected to the fabric. Under normal circumstances, a device (typically an FCP initiator) queries the name server for storage devices within its member zones. Because this limited view is not always sufficient, the management server provides the application with a list of the entire name server database.

## Platform services

By default, all management services except platform services are enabled; the MS platform service and topology discovery are disabled.

You can activate and deactivate the platform services throughout the fabric. Activating the platform services attempts to activate the MS platform service for each switch in the fabric. The change takes effect immediately and is committed to the configuration database of each affected switch. MS activation is persistent across power cycles and reboots.

---

### NOTE

The commands **msplMgmtActivate** and **msplMgmtDeactivate** are allowed only in ADO and AD255.

---

## Platform services and Virtual Fabrics

Each logical switch has a separate Platform Database. All platform registrations done to a logical switch are valid only in that particular logical switch's Virtual Fabric.

Activating the platform services on a switch activates the platform services on all logical switches in a Virtual Fabric. Similarly, deactivating the platform services deactivates the platform service on all logical switches in a Virtual Fabric. The **msPlatShow** command displays all platforms registered in a Virtual Fabric.

## Enabling platform services

When FCS policy is enabled, the **msplMgmtActivate** command can be issued only from the primary FCS switch.

The execution of the **msplMgmtActivate** command is subject to Admin Domain restrictions that may be in place.

1. Connect to the switch and log in using an account assigned to the admin role.
2. Enter the **msCapabilityShow** command to verify that all switches in the fabric support the MS platform service; otherwise, the next step fails.
3. Enter the **msplMgmtActivate** command, as in the following example.

```
switch:admin> msplmgmtactivate  
Request to activate MS Platform Service in progress.....  
*Completed activating MS Platform Service in the fabric!
```

## Disabling platform services

1. Connect to the switch and log in using an account assigned to the admin role.
2. Enter the **msplMgmtDeactivate** command.
3. Enter **y** to confirm the deactivation, as in the following example.

```
switch:admin> msplmgmtdeactivate  
MS Platform Service is currently enabled.  
This will erase MS Platform Service configuration  
information as well as database in the entire fabric.  
Would you like to continue this operation? (yes, y, no, n): [no] y  
Request to deactivate MS Platform Service in progress.....  
*Completed deactivating MS Platform Service in the fabric!
```

## Management server database

You can control access to the management server database.

An access control list (ACL) of WWN addresses determines which systems have access to the management server database. The ACL typically contains those WWNs of host systems that are running management applications.

If the list is empty (the default), the management server is accessible to all systems connected in-band to the fabric. For more access security, you can specify WWNs in the ACL so that access to the management server is restricted to only those WWNs listed.

---

### NOTE

The management server is logical switch-capable. All management server features are supported within a logical switch.

---

## Displaying the management server ACL

1. Connect to the switch and log in using an account assigned to the admin role.

2. Enter the **msConfigure** command.

The command becomes interactive.

3. At the “select” prompt, enter **1** to display the access list.

A list of WWNs that have access to the management server is displayed.

### Example of an empty access list

```
switch:admin> msconfigure
0      Done
1      Display the access list
2      Add member based on its Port/Node WWN
3      Delete member based on its Port/Node WWN
select : (0..3) [1] 1
MS Access list is empty.
0      Done
1      Display the access list
2      Add member based on its Port/Node WWN
3      Delete member based on its Port/Node WWN
select : (0..3) [1] 0
done ...
```

## Adding a member to the ACL

1. Connect to the switch and log in using an account assigned to the admin role.

2. Enter the **msConfigure** command.

The command becomes interactive.

3. At the “select” prompt, enter **2** to add a member based on its port/node WWN.

4. At the “Port/Node WWN” prompt, enter the WWN of the host to be added to the ACL.

5. At the “select” prompt, enter **1** to display the access list so you can verify that the WWN you entered was added to the ACL.

6. After verifying that the WWN was added correctly, enter **0** at the prompt to end the session.
7. At the “Update the FLASH?” prompt, enter **y**.
8. Press **Enter** to update the nonvolatile memory and end the session.

#### Example of adding a member to the management server ACL

```

switch:admin> msconfigure
0      Done
1      Display the access list
2      Add member based on its Port/Node WWN
3      Delete member based on its Port/Node WWN
select : (0..3) [1] 2
Port/Node WWN (in hex): [00:00:00:00:00:00:00:00] 20:00:00:20:37:65:ce:aa
*WWN is successfully added to the MS ACL.
0      Done
1      Display the access list
2      Add member based on its Port/Node WWN
3      Delete member based on its Port/Node WWN
select : (0..3) [2] 1
MS Access List consists of (14): {
 20:00:00:20:37:65:ce:aa
 20:00:00:20:37:65:ce:bb
 20:00:00:20:37:65:ce:ff
 20:00:00:20:37:65:ce:11
 20:00:00:20:37:65:ce:22
 20:00:00:20:37:65:ce:33
 20:00:00:20:37:65:ce:44
 10:00:00:60:69:04:11:24
 10:00:00:60:69:04:11:23
 21:00:00:e0:8b:04:70:3b
 10:00:00:60:69:04:11:33
 20:00:00:20:37:65:ce:55
 20:00:00:20:37:65:ce:66
 00:00:00:00:00:00:00:00
}
0      Done
1      Display the access list
2      Add member based on its Port/Node WWN
3      Delete member based on its Port/Node WWN
select : (0..3) [1] 0
done ...
Update the FLASH? (yes, y, no, n): [yes] y
*Successfully saved the MS ACL to the flash.

```

## Deleting a member from the ACL

When you delete a member from the ACL, that member no longer has access to the management server.

Note that if you delete the last member of the ACL, so that the ACL list is empty, then the management server is accessible to all systems connected in-band to the fabric.

1. Connect to the switch and log in using an account with admin permissions.
2. Enter the **msConfigure** command.  
The command becomes interactive.
3. At the “select” prompt, enter **3** to delete a member based on its port/node WWN.

# 1 Management server database

4. At the “Port/Node WWN” prompt, enter the WWN of the member to be deleted from the ACL.
5. At the “select” prompt, enter **1** to display the access list so you can verify that the WWN you entered was deleted from the ACL.
6. After verifying that the WWN was deleted correctly, enter **0** at the “select” prompt to end the session.
7. At the “Update the FLASH?” prompt, enter **y**.
8. Press **Enter** to update the nonvolatile memory and end the session.

## Example of deleting a member from the management server ACL

```
switch:admin> msconfigure

0      Done
1      Display the access list
2      Add member based on its Port/Node WWN
3      Delete member based on its Port/Node WWN
select : (0..3) [1] 3

Port/Node WWN (in hex): [00:00:00:00:00:00:00:00] 10:00:00:00:c9:29:b3:84
*WWN is successfully deleted from the MS ACL.
0      Done
1      Display the access list
2      Add member based on its Port/Node WWN
3      Delete member based on its Port/Node WWN
select : (0..3) [3] 1

MS Access list is empty

0      Done
1      Display the access list
2      Add member based on its Port/Node WWN
3      Delete member based on its Port/Node WWN
select : (0..3) [1] 0
```

## Viewing the contents of the management server database

1. Connect to the switch and log in using an account assigned to the admin role.
2. Enter the **msPlatShow** command.

## Example of viewing the contents of the management server platform database

```
switch:admin> msplatshow
-----
Platform Name: [9] "first obj"
Platform Type: 5 : GATEWAY
Number of Associated M.A.: 1
[35] "http://java.sun.com/products/plugin"
Number of Associated Node Names: 1
Associated Node Names:
10:00:00:60:69:20:15:71
-----
Platform Name: [10] "second obj"
Platform Type: 7 : HOST_BUS_ADAPTER
Number of Associated M.A.: 1
Associated Management Addresses:
[30] "http://java.sun.com/products/1"
```

```
Number of Associated Node Names: 1
Associated Node Names:
10:00:00:60:69:20:15:75
```

## Clearing the management server database

---

### NOTE

The command **msPIClearDB** is allowed only in ADO and AD255.

---

1. Connect to the switch and log in using an account assigned to the admin role.
2. Enter the **mspicClearDb** command.
3. Enter **y** to confirm the deletion.

The management server platform database is cleared.

## Topology discovery

The topology discovery feature can be displayed, enabled, and disabled; it is disabled by default. The commands **mstdEnable** and **mstdDisable** are allowed only in ADO and AD255.

### Displaying topology discovery status

1. Connect to the switch and log in using an account with admin permissions.
2. Enter the **mstdReadConfig** command.

```
switch:admin> mstdreadconfig
*MS Topology Discovery is Enabled.
```

### Enabling topology discovery

1. Connect to the switch and log in using an account with admin permissions.
2. Enter the appropriate following command based on how you want to enable discovery:
  - For the local switch, enter the **mstdEnable** command.
  - For the entire fabric, enter the **mstdEnable all** command.

#### Example of enabling discovery

```
switch:admin> mstdenable
```

```
Request to enable MS Topology Discovery Service in progress....
*MS Topology Discovery enabled locally.
```

```
switch:admin> mstdenable ALL
```

```
Request to enable MS Topology Discovery Service in progress....
*MS Topology Discovery enabled locally.
*MS Topology Discovery Enable Operation Complete!!
```

## Disabling topology discovery

Topology discovery is disabled by default.

---

### NOTE

Disabling discovery of management server topology might erase all node ID entries.

---

If Admin Domains are enabled, you must be in the ADO or AD255 context. Refer to [Chapter 17, “Managing Administrative Domains,”](#) for additional information.

1. Connect to the switch and log in using an account with admin permissions.
2. Enter the appropriate following command based on how you want to disable discovery:
  - For the local switch, enter the **mstdDisable** command.
  - For the entire fabric, enter the **mstdDisable all** command.A warning displays stating that all NID entries might be cleared.

3. Enter **y** to disable the Topology Discovery feature.

### Example of disabling discovery

```
switch:admin> mstdisable
This may erase all NID entries. Are you sure? (yes, y, no, n): [no] y

Request to disable MS Topology Discovery Service in progress....
*MS Topology Discovery disabled locally.

switch:admin> mstdisable all
This may erase all NID entries. Are you sure? (yes, y, no, n): [no] y

Request to disable MS Topology Discovery Service in progress....
*MS Topology Discovery disabled locally.
*MS Topology Discovery Disable Operation Complete!!
```

## Device login

A device can be storage, a host, or a switch. When new devices are introduced into the fabric, they must be powered on and, if a host or storage device, connected to a switch. Switch-to-switch logins (using the E\_Port) are handled differently than storage and host logins. E\_Ports exchange different frames than the ones listed below with the Fabric Controller to access the fabric. Once storage and host devices are powered on and connected, the following logins occur:

1. FLOGI—Fabric Login command establishes a 24-bit address for the device logging in, and establishes buffer-to-buffer credits and the class of service supported.
2. PLOGI—Port Login command logs the device into the name server to register its information and query for devices that share its zone. During the PLOGI process, information is exchanged between the new device and the fabric. Some of the following types of information exchanges occur:
  - SCR—State Change Registration registers the device for State Change Notifications. If a change in the fabric occurs, such as a zoning change or a change in the state of a device to which this device has access, the device receives a Registered State Change Notification (RSCN).
  - Registration—A device exchanges registration information with the name server.
  - Query—Devices query the name server for information about the device it can access.



## Principal switch

In a fabric with multiple switches, and one inter-switch link (ISL) exists between any two switches, a principal switch is automatically elected. The principal switch provides the following capabilities:

- Maintains time for the entire fabric. Subordinate switches synchronize their time with the principal switch. Changes to the clock server value on the principal switch are propagated to all switches in the fabric.
- Manages domain ID assignment within the fabric. If a switch requests a domain ID that has been used before, the principal switch grants the same domain ID unless it is in use by another switch.

## E\_Port login

An E\_Port does not use a FLOGI to log in to another switch. Instead, the new switch exchanges frames with the principal switch to establish that the new switch is an E\_Port and that it has information to exchange. If everything is acceptable to the principal switch, it replies to the new switch with an SW\_ACC (accept) frame. The initializing frame is an Exchange Link Parameters (ELP) frame that allows an exchange of parameters between two ports, such as flow control, buffer-to-buffer credits, RA\_TOV, and ED\_TOV. This is not a negotiation. If one or the other port's link parameters do not match, a link does not occur. Once an SW\_ACC frame is received from the principal switch, the new switch sends an Exchange Switch Capabilities (ESC) frame. The two switches exchange routing protocols and agree on a common routing protocol. An SW\_ACC frame is received from the principal switch and the new switch sends an Exchange Fabric Parameters (EFP) frame to the principal switch, requesting principal switch priority and the domain ID list. Buffer-to-buffer credits for the device and switch ports are exchanged in the SW\_ACC command sent to the device in response to the FLOGI.

## Fabric login

A device performs a fabric login (FLOGI) to determine if a fabric is present. If a fabric is detected then it exchanges service parameters with the fabric controller. A successful FLOGI sends back the 24-bit address for the device in the fabric. The device must issue and successfully complete a FLOGI command before communicating with other devices in the fabric.

Because the device does not know its 24-bit address until after the FLOGI, the source ID (SID) in the frame header of the FLOGI request are zeros (0x000000).

## Port login process

The steps in the port initialization process occur as the result of a protocol that functions to discover the type of device connected and establish the port type and negotiate port speed.

The possible port types are as follows:

- U\_Port — A universal FC port is the base Fibre Channel port type, and all unidentified or uninitiated ports are listed as U\_Ports.
- L\_/FL\_Port — A loop or fabric loop port connects loop devices. L\_Ports are associated with private loop devices and FL\_Ports are associated with public loop devices.
- G\_Port — A generic port acts as a transition port for non-loop fabric-capable devices.
- E\_Port — An expansion port is assigned to ISL links to expand your fabric by connecting it to other switches.

# 1 Device login

- F\_Port — A fabric port is assigned to fabric-capable devices, such as SAN storage devices.
- EX\_Port — A type of E\_Port that connects a Fibre Channel router to an edge fabric. From the point of view of a switch in an edge fabric, an EX\_Port appears as a normal E\_Port. It follows applicable Fibre Channel standards as other E\_Ports. However, the router terminates EX\_Ports rather than allowing different fabrics to merge as would happen on a switch with regular E\_Ports.
- Mirror Port — A mirror port is a configured switch port that connects to a port to mirror a specific source port and destination port traffic passing through any switch port. This is only supported between F\_Ports.
- VE\_Port — A virtual E\_Port is a gigabit Ethernet switch port configured for an FCIP tunnel.
- VEX\_Port — A virtual EX\_Port connects a Fibre Channel router to an edge fabric. From the point of view of a switch in an edge fabric, a VEX\_Port appears as a normal VE\_Port. It follows the same Fibre Channel protocol as other VE\_Ports. However, the router terminates VEX\_Ports rather than allowing different fabrics to merge as would happen on a switch with regular VE\_Ports.

The Fibre Channel protocol (FCP) auto discovery process enables private storage devices that accept the process login (PRLI) to communicate in a fabric.

If device probing is enabled, the embedded port performs a PLOGI and attempts a PRLI into the device to retrieve information to enter into the name server. This enables private devices that do not perform a FLOGI, but accept a PRLI, to be entered in the name server and receive full fabric access.

A fabric-capable device registers its information with the name server during a FLOGI. These devices typically register information with the name server before querying for a device list. The embedded port still performs a PLOGI and attempts a PRLI with these devices.

If a port decides to end the current session, it initiates a logout. A logout concludes the session and terminates any work in progress associated with that session.

To display the contents of a switch's name server, use the **nsShow** or **nsAllShow** command. For more information about these commands, refer to the *Fabric OS Command Reference*.

## RSCNs

An Registered State Change Notification (RSCN) is a notification frame that is sent to devices that are zoned together and are registered to receive a State Change Notification (SCN). The RSCN is responsible for notifying all devices of fabric changes. The following general list of actions can cause an RSCN to be sent through your fabric:

- A new device has been added to the fabric.
- An existing device has been removed from the fabric.
- A zone has changed.
- A switch name has changed or an IP address has changed.
- Nodes leaving or joining the fabric, such as zoning, powering on or shutting down a device, or zoning changes.

---

### NOTE

Fabric reconfigurations with no domain change do not cause an RSCN.

---

## Duplicate Port World Wide Name

According to Fibre Channel standards, the Port World Wide Name (PWWN) of a device cannot overlap with that of another device, thus having duplicate PWWNs within the same fabric is an illegal configuration.

If a PWWN conflict occurs with two devices attached to the same domain, Fabric OS handles device login in such a way that only one device may be logged in to the fabric at a time. For more information, refer to [“Configuring FLOGI-time handling of duplicate PWWN”](#) on page 60.

If a PWWN conflict occurs and two duplicate devices are attached to the fabric through different domains, the devices are removed from the Name Server database and a RASlog is generated.

### *Device Recovery*

To recover devices that have been removed from the Name Server database due to duplicate PWWNs, the devices must re-login to the fabric. This is true for any device—for example, a device on an F\_Port, NPIV devices, or devices attached to a switch in Access Gateway mode.

## High availability of daemon processes

Starting non-critical daemons is automatic; you cannot configure the startup process. The following sequence of events occurs when a non-critical daemon fails:

1. A RASlog and AUDIT event message are logged.
2. The daemon is automatically started again.
3. If the restart is successful, then another message is sent to RASlog and AUDIT reporting the successful restart status.
4. If the restart fails, another message is sent to RASlog and no further attempts are made to restart the daemon.

Schedule downtime and reboot the switch at your convenience. [Table 1](#) lists the daemons that are considered non-critical and are automatically restarted on failure.

**TABLE 1** Daemons that are automatically restarted

Daemon	Description
arrd	Asynchronous Response Router, which is used to send management data to hosts when the switch is accessed through the APIs (FA API or SMI-S).
cald	Common Access Layer daemon, which is used by manageability applications.
raslogd	Reliability, Availability, and Supportability daemon logs error detection, reporting, handling, and presentation of data into a format readable by you and management tools.
rpcd	Remote Procedure Call daemon, which is used by the API (Fabric Access API and SMI-S).
snmpd	Simple Network Management Protocol daemon.
traced	Trace daemon provides trace entry date and time translation to Trace Device at startup and when date/time changed by command. Maintains the trace dump trigger parameters in a Trace Device. Performs the trace Background Dump, trace automatic FTP, and FTP “aliveness check” if auto-FTP is enabled.
trafd	Traffic daemon implements Bottleneck detection.

# 1 High availability of daemon processes

**TABLE 1** Daemons that are automatically restarted (Continued)

Daemon	Description
webd	Webserver daemon used for WebTools (includes httpd as well).
weblinkerd	Weblinker daemon provides an HTTP interface to manageability applications for switch management and fabric discovery.

# Performing Basic Configuration Tasks

---

## In this chapter

• Fabric OS overview .....	15
• Fabric OS command line interface .....	16
• Password modification .....	19
• The Ethernet interface on your switch .....	20
• Date and time settings .....	25
• Domain IDs .....	28
• Switch names .....	30
• Chassis names .....	30
• Fabric name .....	31
• Switch activation and deactivation .....	32
• Switch and Backbone shutdown .....	32
• Basic connections .....	33

## Fabric OS overview

This chapter describes how to configure your Brocade SAN using the Fabric OS command line interface (CLI). Before you can configure a storage area network (SAN), you must power up the Backbone platform or switch and blades, and then set the IP addresses of those devices. Although this chapter focuses on configuring a SAN using the CLI, you can also use the following methods to configure a SAN:

- Web Tools

For Web Tools procedures, refer to *Web Tools Administrator's Guide*.

- Brocade Network Advisor

For additional information, refer to the *Brocade Network Advisor User Manual* for the version you have.

- A third-party application using the API

For third-party application procedures, refer to the third-party API documentation.

Because of the differences between fixed-port and variable-port devices, procedures sometimes differ among Brocade models. As new Brocade models are introduced, new features sometimes apply only to those models.

When procedures or parts of procedures apply to some models but not others, this guide identifies the specifics for each model. For example, a number of procedures that apply only to variable-port devices are found in [Chapter 3, "Performing Advanced Configuration Tasks"](#).

Although many different software and hardware configurations are tested and supported by Brocade Communications Systems, Inc., documenting all possible configurations and scenarios is beyond the scope of this document. In some cases, earlier releases are highlighted to present considerations for interoperating with them.

The hardware reference manuals for Brocade products describe how to power up devices and set their IP addresses. After the IP address is set, you can use the CLI procedures contained in this guide. For additional information about the commands used in the procedures, refer to the *Fabric OS Command Reference*.

## Fabric OS command line interface

Fabric OS uses Role-Based Access Control (RBAC) to control access to all Fabric OS operations. Each feature is associated with an RBAC role and you need to know which role is allowed to run a command, make modifications to the switch, or view the output of the command. To determine which RBAC role you need to run a command, review the section [“Role-Based Access Control”](#) on page 82.

---

### NOTE

When command examples in this guide show user input enclosed in quotation marks, the quotation marks are required.

---

## Console sessions using the serial port

Note the following behaviors for serial connections:

- Some procedures require that you connect through the serial port; for example, setting the IP address or setting the boot PROM password.
- Brocade DCX and DCX 8510 Backbone families: You can connect to CP0 or CP1 using either of the two serial ports.

### *Connecting to Fabric OS through the serial port*

1. Connect the serial cable to the serial port on the switch and to an RS-232 serial port on the workstation.

If the serial port on the workstation is an RJ-45 port, instead of RS-232, remove the adapter on the end of the serial cable and insert the exposed RJ-45 connector into the RJ-45 serial port on the workstation.

2. Open a terminal emulator application (such as HyperTerminal on a PC, TERM, TIP, or Kermit in a UNIX environment), and configure the application as follows:
  - In a Windows environment enter the following parameters:

**TABLE 2** Terminal port parameters

Parameter	Value
Bits per second	9600
Databits	8
Parity	None

**TABLE 2** Terminal port parameters (Continued)

Parameter	Value
Stop bits	1
Flow control	None

- In a UNIX environment, enter the following string at the prompt:

```
tip /dev/ttyb -9600
```

If ttyb is already in use, use ttya instead and enter the following string at the prompt:

```
tip /dev/ttya -9600
```

## Telnet or SSH sessions

Connect to the Fabric OS through a Telnet or SSH connection or through a console session on the serial port. The switch must also be physically connected to the network. If the switch network interface is not configured or the switch has been disconnected from the network, use a console session on the serial port as described in [“Console sessions using the serial port”](#) on page 16.

---

### NOTE

To automatically configure the network interface on a DHCP-enabled switch, plug the switch into the network and power it on. The DHCP client automatically gets the IP and gateway addresses from the DHCP server. The DHCP server must be on the same subnet as the switch. Refer to [“DHCP activation”](#) on page 23.

---

### *Rules for Telnet connections*

The following rules must be observed when making Telnet connections to your switch:

- Never change the IP address of the switch while two Telnet sessions are active; if you do, your next attempt to log in fails. To recover, gain access to the switch by one of these methods:
  - You can use Web Tools to perform a fast boot. When the switch comes up, the Telnet quota is cleared. (For instructions on performing a fast boot with Web Tools, see the *Web Tools Administrator’s Guide*.)
  - If you have the required privileges, you can connect through the serial port, log in as admin, and use the **killTelnet** command to identify and kill the Telnet processes without disrupting the fabric.
- For accounts with an admin role, Fabric OS limits the number of simultaneous Telnet sessions per switch to two. For more details on session limits, refer to [Chapter 5, “Managing User Accounts”](#).

### *Connecting to Fabric OS using Telnet*

1. Connect through a serial port to the switch that is appropriate for your fabric:
  - If Virtual Fabrics is enabled, log in using an admin account assigned the chassis-role permission.
  - If Virtual Fabrics is not enabled, log in using an account assigned to the admin role.
2. Verify the switch’s network interface is configured and that it is connected to the IP network through the RJ-45 Ethernet port.

Switches in the fabric that are not connected through the Ethernet port can be managed through switches that are using IP over Fibre Channel. The embedded port must have an assigned IP address.

3. Log off the switch’s serial port.
4. From a management station, open a Telnet connection using the IP address of the switch to which you want to connect.

The login prompt is displayed when the Telnet connection finds the switch in the network.

5. Enter the account ID at the login prompt.
6. Enter the password.

If you have not changed the system passwords from the default, you are prompted to change them. Enter the new system passwords, or press **Ctrl+C** to skip the password prompts. For more information on system passwords, refer to “Default account passwords” on page 19.

7. Verify the login was successful.

The prompt displays the switch name and user ID to which you are connected.

```
login: admin
password: xxxxxxxx
```

## Getting help on a command

You can display a list of all command help topics for a given login level. For example, if you log in as user and enter the **help** command, a list of all user-level commands that can be executed is displayed. The same rule applies to the admin, securityAdmin, and the switchAdmin roles.

1. Connect to the switch and log in using an account assigned to the admin role.
2. Enter the **help [ |more]** command with no specific command and all commands are displayed.

The optional **|more** argument displays the commands one page at a time.

For command-specific information, you can enter **help command |more**, where *command* is the name of the command for which you need specific information.

The commands in the following table provides help files for the indicated specific topics.

**TABLE 3 Help topic contents**

Topic name	Help contents description
<b>diagHelp</b>	Diagnostic help information
<b>ficonHelp</b>	FICON help information
<b>fwHelp</b>	Fabric Watch help information
<b>iscsiHelp</b>	iSCSI help information
<b>licenseHelp</b>	License help information
<b>perfHelp</b>	Performance Monitoring help information
<b>routeHelp</b>	Routing help information
<b>trackChangesHelp</b>	Track Changes help information
<b>zoneHelp</b>	Zoning help information



## Password modification

The switch automatically prompts you to change the default account passwords after logging in for the first time. If you do not change the passwords, the switch prompts you after each subsequent login until all the default passwords have been changed.

---

### NOTE

The default account passwords can be changed from their original values only when prompted immediately following the login; the passwords cannot be changed using the `passwd` command later in the session. If you skip the prompt, and then later decide to change the passwords, log out and then back in.

---

The default accounts on the switch are admin, user, root, and factory. Use the “admin” account to log in to the switch for the first time and to perform the basic configuration tasks. The password for all of these accounts is “password”.

There is only one set of default accounts for the entire chassis. The root and factory default accounts are reserved for development and manufacturing. The user account is primarily used for system monitoring. For more information on default accounts, refer to “[Default accounts](#)” on page 85.

## Default account passwords

The change default account passwords prompt is a string that begins with the message “Please change your passwords now”. User-defined passwords can have from 8 through 40 characters. They must begin with an alphabetic character and can include numeric characters, the period (.), and the underscore ( \_ ). They are case-sensitive, and they are not displayed when you enter them on the command line.

Record the passwords exactly as entered and store them in a secure place because recovering passwords requires significant effort and fabric downtime. Although the root and factory accounts are not meant for general use, change their passwords if prompted to do so and save the passwords in case they are needed for recovery purposes.

### *Changing the default account passwords at login*

1. Connect to the switch and log in using the default administrative account.
2. At each of the “Enter new password” prompts, either enter a new password or skip the prompt.

To skip a single prompt, press **Enter**. To skip all of the remaining prompts, press **Ctrl-C**.

#### Example output of changing passwords

```
login: admin
Password:
Please change your passwords now.
Use Control-C to exit or press 'Enter' key to proceed.
for user - root
Changing password for root
Enter new password: <hidden>
Password changed.
Saving password to stable storage.
Password saved to stable storage successfully.
(output truncated)
```

## The Ethernet interface on your switch

The Ethernet (network) interface provides management access, including direct access to the Fabric OS CLI, and allows other tools, such as Web Tools, to interact with the switch. You can use either Dynamic Host Configuration Protocol (DHCP) or static IP addresses for the Ethernet network interface configuration. On Brocade Backbones, you must set IP addresses for the following components:

- Both Control Processors (CPO and CP1)
- Chassis management IP

On the Brocade switches, you must set the Ethernet and chassis management IP interfaces.

Setting the chassis management IP address eliminates the need to know which CP is active and automatically connects the requestor to the currently active CP.

You can continue to use a static Ethernet addressing system or allow the DHCP client to automatically acquire Ethernet addresses. Configure the Ethernet interface IP address, subnet mask, and gateway addresses in one of the following manners:

- Using static Ethernet addresses (refer to [“Static Ethernet addresses”](#) on page 22)
- Activating DHCP (refer to [“DHCP activation”](#) on page 23)

---

### NOTE

When you change the Ethernet interface settings, open connections such as SSH or Telnet may be dropped. Reconnect using the new Ethernet IP address information or change the Ethernet settings using a console session through the serial port to maintain your session during the change. You must connect through the serial port to set the Ethernet IP address if the Ethernet network interface is not configured already. For details, refer to [“Connecting to Fabric OS through the serial port”](#) on page 16.

---

## Virtual Fabrics and the Ethernet interface

On the Brocade DCX and DCX-4S, the single-chassis IP address and subnet mask are assigned to the management Ethernet ports on the front panels of the CPs. These addresses allow access to the chassis—more specifically, the active CP of the chassis—and not individual logical switches. The IP addresses can also be assigned to each CP individually. This allows for direct communication with a CP, including the standby CP. On the Brocade DCX and DCX-4S Backbones, each CP has two management Ethernet ports on its front panel. These two physical ports are bonded together to create a single, logical Ethernet port, and it is the logical Ethernet port to which IP addresses are assigned.

IPv4 addresses assigned to individual Virtual Fabrics are assigned to IP over Fibre Channel (IPFC) network interfaces. In Virtual Fabrics environments, a single chassis can be assigned to multiple fabrics, each of which is logically distinct and separate from one another. Each IPFC point of connection to a given chassis needs a separate IPv4 address and prefix to be accessible to a management host. For more information on how to set up these IPFC interfaces to your Virtual Fabric, refer to [Chapter 10, “Managing Virtual Fabrics”](#).

## Displaying the network interface settings

If an IP address has not been assigned to the network interface (Ethernet), you must connect to the Fabric OS CLI using a console session on the serial port. For more information, see [“Console sessions using the serial port”](#) on page 16. Otherwise, connect using SSH.

1. Connect to the switch and log in using an account assigned to the admin role.
2. Enter the `ipAddrShow` command.

### Example output of a Brocade Backbone

```

ecp:admin> ipaddrshow
SWITCH
Ethernet IP Address: 10.1.2.3
Ethernet Subnetmask: 255.255.240.0

CP0
Ethernet IP Address: 10.1.2.3
Ethernet Subnetmask: 255.255.240.0
Host Name: ecp0
Gateway IP Address: 10.1.2.1

CP1
Ethernet IP Address: 10.1.2.4
Ethernet Subnetmask: 255.255.240.0
Host Name: ecp1
Gateway IP Address: 10.1.2.3

IPFC address for virtual fabric ID 123: 11.1.2.3/24
IPFC address for virtual fabric ID 45: 13.1.2.4/20

Slot 7
eth0: 11.1.2.4/24
Gateway: 11.1.2.1

Backplane IP address of CP0 : 10.0.0.5
Backplane IP address of CP1 : 10.0.0.6

IPv6 Autoconfiguration Enabled: Yes
Local IPv6 Addresses:
sw 0 stateless fd00:60:69bc:70:260:69ff:fe00:2/64 preferred
sw 0 stateless fec0:60:69bc:70:260:69ff:fe00:2/64 preferred
cp 0 stateless fd00:60:69bc:70:260:69ff:fe00:197/64 preferred
cp 0 stateless fec0:60:69bc:70:260:69ff:fe00:197/64 preferred
cp 1 stateless fd00:60:69bc:70:260:69ff:fe00:196/64 preferred
cp 1 stateless fec0:60:69bc:70:260:69ff:fe00:196/64 preferred
IPv6 Gateways:
cp 0 fe80:60:69bc:70::3
cp 0 fe80:60:69bc:70::2
cp 0 fe80:60:69bc:70::1
cp 1 fe80:60:69bc:70::3

```

If the Ethernet IP address, subnet mask, and gateway address are displayed, then the network interface is configured. Verify the information on your switch is correct. If DHCP is enabled, the network interface information was acquired from the DHCP server.

---

### NOTE

You can use either IPv4 or IPv6 with a classless inter-domain routing (CIDR) block notation (also known as a *network prefix length*) to set up your IP addresses.

---

### Static Ethernet addresses

Use static Ethernet network interface addresses on Brocade DCX and DCX-4S Backbones, and in environments where DHCP service is not available. To use static addresses for the Ethernet interface, you must first disable DHCP. You can enter static Ethernet information and disable DHCP at the same time. For more information, refer to “[DHCP activation](#)” on page 23.

If you choose not to use DHCP or to specify an IP address for your switch Ethernet interface, you can do so by entering “none” or “0.0.0.0” in the Ethernet IP address field.

On an application blade, configure the two external Ethernet interfaces to two different subnets. If two subnets are not present, configure one of the interfaces and leave the other unconfigured. Otherwise, the following message displays and blade status may go into a faulty state after a reboot.

```
Neighbor table overflow.  
print: 54 messages suppressed
```

### *Setting the static addresses for the Ethernet network interface*

1. Connect to the switch and log in using an account assigned to the admin role.
2. Perform the appropriate action based on whether you have a switch or Backbone:
  - If you are setting the IP address for a switch, enter the **ipAddrSet** command.
  - If you are setting the IP address for a Backbone, enter the **ipAddrSet** command specifying either CPO or CP1. You must set the IP address for both CPO and CP1.

#### Example of setting the IPv4 address

```
switch:admin> ipaddrset  
Ethernet IP Address [10.1.2.3]:  
Ethernet Subnetmask [255.255.255.0]:  
Fibre Channel IP Address [220.220.220.2]:  
Fibre Channel Subnetmask [255.255.0.0]:  
Gateway IP Address [10.1.2.1]:  
DHCP [OFF]: off
```

#### Example of setting an IPv6 address on a switch

```
switch:admin> ipaddrset -ipv6 --add 1080::8:800:200C:417A/64  
IP address is being changed...Done.
```

For more information on setting up an IP address for a Virtual Fabric, refer to [Chapter 10](#), “[Managing Virtual Fabrics](#)”.

3. Enter the network information in dotted-decimal notation for the Ethernet IPv4 address or in semicolon-separated notation for IPv6.
4. Enter the Ethernet Subnetmask at the prompt.
5. Skip the Fibre Channel prompts by pressing **Enter**.  
The Fibre Channel IP address is used for management.
6. Enter the Gateway Address at the prompt.
7. Disable DHCP by entering **off**.

### *Setting the static addresses for the chassis management IP interface*

1. Connect to the switch and log in using an account assigned to the admin role.
2. Enter the **ipAddrSet -chassis** command.
 

```
switch:admin> ipaddrset -chassis
Ethernet IP Address [192.168.166.148]:
Ethernet Subnetmask [255.255.255.0]:
Committing configuration...Done.
```
3. Enter the network information in dotted-decimal notation for the Ethernet IPv4 address or in semicolon-separated notation for IPv6.
4. Enter the Ethernet Subnet mask at the prompt.

## DHCP activation

By default, some Brocade switches have DHCP enabled.

---

### NOTE

The Brocade DCX and Brocade DCX-4S Backbones do not support DHCP.

---

The Fabric OS DHCP client supports the following parameters:

- External Ethernet port IP addresses and subnet masks
- Default gateway IP address

The DHCP client uses a DHCP vendor-class identifier that allows DHCP servers to determine that the discover/request packet are coming from a Brocade switch. The vendor-class identifier is the string “BROCADE” followed by the SWBD model number of the platform. For example, the vendor-class identifier for a request from a Brocade 5300 is “BROCADESWBD64.”

---

### NOTE

The client conforms to the latest IETF Draft Standard RFCs for IPv4, IPv6, and DHCP.

---

### *Enabling DHCP*

Connect the DHCP-enabled switch to the network, power on the switch, and the switch automatically obtains the Ethernet IP address, Ethernet subnet mask, and default gateway address from the DHCP server. The DHCP client can only connect to a DHCP server on the same subnet as the switch. Do not enable DHCP if the DHCP server is not on the same subnet as the switch.

Enabling DHCP after the Ethernet information has been configured releases the current Ethernet network interface settings, including Ethernet IP address, Ethernet subnet mask, and gateway IP address. The Fibre Channel IP address and subnet mask are static and are not affected by DHCP; for instructions on setting the FC IP address, see [“Static Ethernet addresses”](#) on page 22.

1. Connect to the switch and log in using an account assigned to the admin role.
2. Enter the **ipAddrSet** command.
3. If already set up, skip the Ethernet IP address, Ethernet subnet mask, Fibre Channel IP address, and Fibre Channel subnet mask prompts by pressing **Enter**.

## 2 The Ethernet interface on your switch

4. Enable DHCP by entering **on**.

```
switch:admin> ipaddrset
Ethernet IP Address [10.1.2.3]:
Ethernet Subnetmask [255.255.255.0]:
Fibre Channel IP Address [220.220.220.2]:
Fibre Channel Subnetmask [255.255.0.0]:
Gateway IP Address [10.1.2.1]:
DHCP [Off]:on
```

### *Disabling DHCP*

When you disable DHCP, enter the static Ethernet IP address and subnet mask of the switch and default gateway address. Otherwise, the Ethernet settings may conflict with other addresses assigned by the DHCP server on the network.

1. Connect to the switch and log in using an account assigned to the admin role.
2. Enter the **ipAddrSet** command.
3. Enter the network information in dotted-decimal notation for the Ethernet IPv4 address or in semicolon-separated notation for IPv6.

If a static Ethernet address is not available when you disable DHCP, enter **0.0.0.0** at the Ethernet IP address prompt.

4. Skip the Fibre Channel prompts by pressing **Enter**.
5. When you are prompted for DHCP[On], disable it by entering **off**.

```
switch:admin> ipaddrset
Ethernet IP Address [10.1.2.3]:
Ethernet Subnetmask [255.255.255.0]:
Fibre Channel IP Address [220.220.220.2]:
Fibre Channel Subnetmask [255.255.0.0]:
Gateway IP Address [10.1.2.1]:
DHCP [On]:off
```

### IPv6 autoconfiguration

IPv6 can assign multiple IP addresses to each network interface. Each interface is configured with a link local address in almost all cases, but this address is only accessible from other hosts on the same network. To provide for wider accessibility, interfaces are typically configured with at least one additional global scope IPv6 address. IPv6 autoconfiguration allows more IPv6 addresses, the number of which is dependent on the number of routers serving the local network and the number of prefixes they advertise.

There are two methods of autoconfiguration for IPv6 addresses: stateless autoconfiguration and stateful autoconfiguration. *Stateless* allows an IPv6 host to obtain a unique address using the IEEE 802 MAC address; *stateful* uses a DHCPv6 server, which keeps a record of the IP address and other configuration information for the host. Whether a host engages in autoconfiguration and which method it uses is dictated by the routers serving the local network, not by a configuration of the host. There can be multiple routers serving the network, each potentially advertising multiple network prefixes. Thus, the host is not in full control of the number of IPv6 addresses that it configures, much less the values of those addresses, and the number and values of addresses can change as routers are added to or removed from the network.

When IPv6 autoconfiguration is enabled, the platform engages in stateless IPv6 autoconfiguration. When IPv6 autoconfiguration is disabled, the platform relinquishes usage of any autoconfigured IPv6 addresses that it may have acquired while it was enabled. This same enable or disable state also enables or disables the usage of a link local address for each managed entity, though a link local address continues to be generated for each nonchassis-based platform and for each CP of a chassis-based platform because those link local addresses are required for router discovery. The enabled or disabled state of autoconfiguration is independent of whether any static IPv6 addresses have been configured.

### *Setting IPv6 autoconfiguration*

1. Connect to the switch and log in using an account assigned to the admin role.
2. Take the appropriate following action based on whether you want to enable or disable IPv6 autoconfiguration:
  - Enter the `ipAddrSet -ipv6 -auto` command to enable IPv6 autoconfiguration for all managed entities on the target platform.
  - Enter the `ipAddrSet -ipv6 -noauto` command to disable IPv6 autoconfiguration for all managed entities on the target platform.

## Date and time settings

Switches maintain the current date and time inside a battery-backed real-time clock (RTC) circuit that receives the date and time from the fabric's principal switch. Date and time are used for logging events. Switch operation does not depend on the date and time; a switch with an incorrect date and time value functions properly. However, because the date and time are used for logging, error detection, and troubleshooting, you must set them correctly.

In a Virtual Fabric, there can be a maximum of eight logical switches per Backbone. Only the default switch in the chassis can update the hardware clock. When the `date` command is issued from a non-principal pre-Fabric OS v6.2.0 or earlier switch, the `date` command request is dropped by a Fabric OS v6.2.0 and later switch and the pre-Fabric OS v6.2.0 switch or earlier does not receive an error.

Authorization access to set or change the date and time for a switch is role-based. For an understanding of role-based access, refer to ["Role-Based Access Control"](#) on page 82.

### Setting the date and time

1. Connect to the switch and log in using an account assigned to the admin role.
2. Enter the `date` command, using the following syntax:

```
date "mmddHHMMyy"
```

The values represent the following:

- mm is the month; valid values are 01 through 12.
- dd is the date; valid values are 01 through 31.
- HH is the hour; valid values are 00 through 23.
- MM is minutes; valid values are 00 through 59.

## 2 Date and time settings

- `yy` is the year, valid values are 00 through 37 and 70 through 99 (year values from 70 through 99 are interpreted as 1970 through 1999, year values from 00 through 37 are interpreted as 2000 through 2037).

### Example of showing and setting the date

```
switch:admin> date
Fri Sep 29 17:01:48 UTC 2007
Stealth200E:admin> date "0204101008"
Mon Feb 4 10:10:00 UTC 2008
```

## Time zone settings

You can set the time zone for a switch by name. You can specify the setting using country and city or time zone parameters. Switch operation does not depend on a date and time setting. However, having an accurate time setting is needed for accurate logging and audit tracking.

If the time zone is not set with new options, the switch retains the offset time zone settings. The **tsTimeZone** command includes an option to revert to the prior time zone format. For more information about the **tsTimeZone** command, refer to the *Fabric OS Command Reference*.

When you set the time zone for a switch, you can perform the following tasks:

- Display all of the time zones supported in the firmware.
- Set the time zone based on a country and city combination or based on a time zone ID, such as PST.

The time zone setting has the following characteristics:

- Users can view the time zone settings. However, only those with administrative permissions can set the time zones.
- The setting automatically adjusts for Daylight Savings Time.
- Changing the time zone on a switch updates the local time zone setup and is reflected in local time calculations.
- By default, all switches are set to Greenwich Mean Time (0,0). If all switches in a fabric are in one time zone, it is possible for you to keep the time zone setup at the default setting.
- System services that have already started reflect the time zone changes after the next reboot.
- Time zone settings persist across failover for high availability.

Setting the time zone on any dual domain Backbone has the following characteristics:

- Updating the time zone on any switch updates the entire Backbone.
- The time zone of the entire Backbone is the time zone of switch 0.

### *Setting the time zone*

The following procedure describes how to set the time zone for a switch. You must perform the procedure on *all* switches for which the time zone must be set. However, you only need to set the time zone once on each switch because the value is written to nonvolatile memory.

1. Connect to the switch and log in using an account assigned to the admin role and with the chassis-role permission.
2. Enter the **tsTimeZone** command.



- Use **tsTimeZone** with no parameters to display the current time zone setting.
- Use **--interactive** to list all of the time zones supported by the firmware.
- Use **timeZone\_fmt** to set the time zone by Country/City or by time zone ID, such as Pacific Standard Time (PST).

#### Example of displaying and changing the time zone to US/Central

```
switch:admin> tstimezone
Time Zone : US/Pacific
switch:admin> tstimezone US/Central
switch:admin> tstimezone
Time Zone : US/Central
```

### *Setting the time zone interactively*

The following procedure describes how to set the current time zone to PST using interactive mode.

1. Connect to the switch and log in using an account assigned to the admin role and with the chassis-role permission.

2. Enter the **tsTimeZone --interactive** command.

You are prompted to select a general location.

```
Please identify a location so that time zone rules can be set correctly.
```

3. Enter the appropriate number or press **Ctrl-D** to quit.
4. Select a country location at the prompt.
5. Enter the appropriate number at the prompt to specify the time zone region of **Ctrl-D** to quit.

## Network time protocol

You can synchronize the local time of the principal and primary FCS switch to a maximum of eight external Network Time Protocol (NTP) servers. To keep the time in your SAN current, it is recommended that the principal or primary FCS switch has its time synchronized with at least one external NTP server. The other switches in the fabric automatically take their time from the principal or primary FCS switch, as described in [“Synchronizing the local time with an external source.”](#)

All switches in the fabric maintain the current clock server value in nonvolatile memory. By default, this value is the local clock server (LOCL) of the principal or primary FCS switch. Changes to the clock server value on the principal or primary FCS switch are propagated to all switches in the fabric.

In a Virtual Fabric, all the switches in the fabric must have the same NTP clock server configured. This includes any Fabric OS v6.2.0 or earlier switches in the fabric. This ensures that time does not go out of sync in the logical fabric. It is not recommended to have LOCL in the server list.

When a new switch enters the fabric, the time server daemon of the principal or primary FCS switch sends out the addresses of all existing clock servers and the time to the new switch. When a switch enters the fabric, it stores the list and the active servers.

---

#### NOTE

In a Virtual Fabric, multiple logical switches can share a single chassis. Therefore, the NTP server list must be the same across all fabrics.

---

### *Synchronizing the local time with an external source*

The **tsClockServer** command accepts multiple server addresses in IPv4, IPv6, or Domain Name System (DNS) name formats. When multiple NTP server addresses are passed, **tsClockServer** sets the first obtainable address as the active NTP server. The rest are stored as backup servers that can take over if the active NTP server fails. The principal or primary FCS switch synchronizes its time with the NTP server every 64 seconds.

1. Connect to the switch and log in using an account assigned to the admin role.
2. Enter the **tsClockServer** command.

```
switch:admin> tsclockserver "ntp1;ntp2"
```

In this syntax, *ntp1* is the IP address or DNS name of the first NTP server, which the switch must be able to access. The second variable, *ntp2*, is the second NTP server and is optional. The operand "*ntp1;ntp2*" is optional; by default, this value is LOCL, which uses the local clock of the principal or primary FCS switch as the clock server.

#### Example of setting the NTP server

```
switch:admin> tsclockserver  
LOCL  
switch:admin> tsclockserver "10.1.2.3"
```

#### Example of displaying the NTP server

```
switch:admin> tsclockserver  
10.1.2.3
```

#### Example of setting up more than one NTP server using a DNS name

```
switch:admin> tsclockserver "10.1.2.4;10.1.2.5;ntp.localdomain.net"  
Updating Clock Server configuration...done.  
Updated with the NTP servers
```

Changes to the clock server value on the principal or primary FCS switch are propagated to all switches in the fabric.

## Domain IDs

Although domain IDs are assigned dynamically when a switch is enabled, you can change them manually so that you can control the ID number or resolve a domain ID conflict when you merge fabrics.

If a switch has a domain ID when it is enabled, and that domain ID conflicts with another switch in the fabric, the conflict is automatically resolved if the other switch's domain ID is not persistently set. The process can take several seconds, during which time traffic is delayed. If both switches have their domain IDs persistently set, one of them needs to have its domain ID changed to a domain ID not used within the fabric.

The default domain ID for Brocade switches is 1.

---

#### ATTENTION

Do not use domain ID 0. The use of this domain ID can cause the switch to reboot continuously. Avoid changing the domain ID on the FCS switch in secure mode. To minimize down time, change the domain IDs on the other switches in the fabric.

---

## Displaying the domain IDs

1. Connect to the switch and log in using an account assigned to the admin role.
2. Enter the **fabricShow** command.

### Example output of fabric information, including the domain ID (D\_ID)

The principal switch is determined by the arrow ( > ) next to the name of the switch. In this output, the principal switch appears in blue boldface.

```
switch:admin> fabricshow
Switch ID   Worldwide Name           Enet IP Addr   FC IP Addr     Name
-----
  2: fffc02  10:00:00:60:69:e0:01:46  10.3.220.1     0.0.0.0        "ras001"
  3: fffc03  10:00:00:60:69:e0:01:47  10.3.220.2     0.0.0.0        "ras002"
  5: fffc05  10:00:00:05:1e:34:01:bd  10.3.220.5     0.0.0.0        "ras005"
                                     fec0:60:69bc:63:205:1eff:fe34:1bd
  6: fffc06  10:00:00:05:1e:34:02:3e  10.3.220.6     0.0.0.0        "ras006"
  7: fffc07  10:00:00:05:1e:34:02:0c  10.3.220.7     0.0.0.0        "ras007"
 10: fffc0a  10:00:00:05:1e:39:e4:5a  10.3.220.10    0.0.0.0        "ras010"
 15: fffc0f  10:00:00:60:69:80:47:74  10.3.220.15    0.0.0.0        "ras015"
 19: fffc13  10:00:00:05:1e:34:00:ad  10.3.220.19    0.0.0.0        "ras019"
                                     fec0:60:69bc:63:219:1eff:fe34:1bd
 20: fffc14  10:00:00:05:1e:40:68:78  10.3.220.20    0.0.0.0        "ras020"
 25: fffc19  10:00:00:05:1e:37:23:c6  10.3.220.25    0.0.0.0        "ras025"
 30: fffc1e  10:00:00:60:69:90:04:1e  10.3.220.30    0.0.0.0        "ras030"
 35: fffc23  10:00:00:05:1e:07:c7:26  10.3.220.35    0.0.0.0        "ras035"
 40: fffc28  10:00:00:60:69:50:06:7f  10.3.220.40    0.0.0.0        "ras040"
 45: fffc2d  10:00:00:05:1e:35:10:72  10.3.220.45    0.0.0.0        "ras045"
 46: fffc2e  10:00:00:05:1e:34:c5:17  10.3.220.46    0.0.0.0        "ras046"
 47: fffc2f  10:00:00:05:1e:02:aa:f7  10.3.220.47    0.0.0.0        >"ras047"
 50: fffc32  10:00:00:60:69:c0:06:64  10.1.220.50    0.0.0.0        "ras050"
(output truncated)
```

The Fabric has 26 switches

Table 4 displays the **fabricShow** fields.

**TABLE 4** fabricShow fields

Field	Description
Switch ID	The switch domain_ID and embedded port D_ID. The numbers are broken down as follows: <b>Example 64: fffc40</b> 64 is the switch domain_ID fffc40 is the hexadecimal format of the embedded port D_ID.
World Wide Name	The switch WWN.
Enet IP Addr	The switch Ethernet IP address for IPv4- and IPv6-configured switches. For IPv6 switches, only the static IP address displays.
FC IP Addr	The switch Fibre Channel IP address.
Name	The switch symbolic or user-created name in quotes.

## Setting the domain ID

1. Connect to the switch and log in on an account assigned to the admin role.
2. Enter the **switchDisable** command to disable the switch.

## 2 Switch names

3. Enter the **configure** command.

4. Enter **y** after the Fabric Parameters prompt.

```
Fabric parameters (yes, y, no, n): [no] y
```

5. Enter a unique domain ID at the Domain prompt. Use a domain ID value from 1 through 239 for normal operating mode (FCSW-compatible).

```
Domain: (1..239) [1] 3
```

6. Respond to the remaining prompts, or press **Ctrl-D** to accept the other settings and exit.

7. Enter the **switchEnable** command to re-enable the switch.

## Switch names

Switches can be identified by IP address, domain ID, World Wide Name (WWN), or by customized switch names that are unique and meaningful.

Switch names can be from 1 through 30 characters long. All switch names must begin with a letter, and can contain letters, numbers, or the underscore character.

---

### NOTE

Changing the switch name causes a domain address format RSCN to be issued and may be disruptive to the fabric.

---

## Customizing the switch name

1. Connect to the switch and log in using an account assigned to the admin role.

2. Enter the **switchName** command and enter a new name for the switch.

```
switch:admin> switchname newname
```

3. Record the new switch name for future reference.

## Chassis names

Brocade recommends that you customize the chassis name for each platform. Some system logs identify devices by platform names; if you assign meaningful platform names, logs are more useful. All chassis names supported by Fabric OS v7.0.0 allow 31 characters. Chassis names must begin with an alphabetic character and can include alphabetic and numeric characters, and the underscore (`_`).?

## Customizing chassis names

1. Connect to the switch and log in using an account assigned to the admin role.

2. Enter the **chassisName** command.

```
ecp:admin> chassisname newname
```

3. Record the new chassis name for future reference.

## Fabric name

You can assign an alphanumeric name to identify and manage a logical fabric that formerly could only be identified by a fabric ID. The fabric name does not replace the fabric ID or its usage. The fabric continues to have a fabric ID, in addition to the assigned alphanumeric fabric name.

Note the considerations:

- Each name must be unique for each logical switch within a chassis; duplicate fabric names are not allowed.
- A fabric name can be from 1 through 128 alphanumeric characters.
- All switches in a logical fabric must be running Fabric OS v7.0.1. Switches running earlier versions of the firmware can co-exist in the fabric, but do not show the fabric name details.
- You must have admin permissions to configure the fabric name.

### Configuring the fabric name

To set and display the fabric name, use the **fabricname** command as shown in the following example:

```
switch:user> fabricname --set myfabric@1
```

Using the **fabricname --set** command without a fabric name takes the existing fabric name and synchronizes it across the entire fabric. An error message displays if no name is configured.

To set a fabric name that includes spaces, enclose the fabric name in quotes, as shown here:

```
switch:user> fabricname --set "my new fabric"
```

To set a fabric name that includes bash special meta-characters or spaces, use the command **fabricname** as shown in the following example:

```
switch:user> fabricname --set 'red fabric $$'
```

To clear the fabric name, use the **fabricname --clear** command.

### High availability considerations for fabric names

Fabric names locally configured or obtained from a remote switch are saved in the configuration database, and then synchronized to the standby CP on dual-CP-based systems.

### Upgrade and downgrade considerations for fabric names

Fabric names are lost during a firmware downgrade. No default fabric name is provided. If a fabric name is needed, it must be configured after the upgrade.

### Config file upload and download considerations for fabric names

A new key, "fabric name" is added to store the user configuration. You can only configure fabric names using config download when the switch is offline.

# Switch activation and deactivation

By default, the switch is enabled after power is applied and diagnostics and switch initialization routines have finished. You can disable and re-enable the switch as necessary.

## Disabling a switch

1. Connect to the switch and log in using an account assigned to the admin role.
2. Enter the **switchDisable** command.

All Fibre Channel ports on the switch are taken offline. If the switch is part of a fabric, the fabric is reconfigured.

## Enabling a switch

1. Connect to the switch and log in using an account assigned to the admin role.
2. Enter the **switchEnable** command.

All Fibre Channel ports that passed Power On Self Test (POST) are enabled. If the switch has inter-switch links (ISLs) to a fabric, it joins the fabric.

# Switch and Backbone shutdown

To avoid corrupting your file system, Brocade recommends that you perform graceful shutdowns of Brocade switches and Backbones.

*Warm reboot* (also known as *graceful shutdown*) refers to shutting down the switch or platform by way of the following instructions. *Cold boot* (also known as a *hard boot*) refers to shutting down the switch or platform by suddenly shutting down power and powering on again.

## Powering off a Brocade switch

The following procedure describes how to gracefully shut down a switch.

1. Connect to the switch and log in using an account assigned to the admin role.
2. Enter the **sysShutdown** command.
3. Enter **y** at the prompt.

```
switch:admin> sysshutdown
This command will shutdown the operating systems on your switch.
You are required to power-cycle the switch in order to restore operation.
Are you sure you want to shutdown the switch [y/n]?y
```

4. Wait until the following message displays:

```
Broadcast message from root (ttyS0) Wed Jan 25 16:12:09 2006...

The system is going down for system halt NOW !!
INIT: Switching to runlevel: 0
INIT: Sending processes the TERM signal
Unmounting all filesystems.
```

```
The system is halted
flushing ide devices: hda
Power down.
```

5. Power off the switch.

## Powering off a Brocade Backbone

1. From the active CP in a dual-CP platform, enter the **sysShutdown** command.

---

### NOTE

When the **sysShutdown** command is issued on the active CP, the active CP, the standby CP, and any application blades are all shut down.

---

2. Enter **y** at the prompt.
3. Wait until the following message displays:

```
DCX:FID128:admin> sysshutdown
This command will shutdown the operating systems on your switch.
You are required to power-cycle the switch in order to restore operation.
Are you sure you want to shutdown the switch [y/n]?y
HA is disabled
Stopping blade 10
Shutting down the blade....
Stopping blade 12
Shutting down the blade....

Broadcast message from root (pts/0) Fri Oct 10 08:36:48 2008...

The system is going down for system halt NOW !!
```

4. Power off the switch.

## Basic connections

Before connecting a switch to a fabric that contains switches running different firmware versions, you must first set the same port identification (PID) format on all switches. The presence of different PID formats in a fabric causes fabric segmentation.

- For information on PID formats and related procedures, refer to [Chapter 3, “Performing Advanced Configuration Tasks”](#).
- For information on configuring the routing of connections, refer to [Chapter 4, “Routing Traffic”](#).
- For information on configuring extended inter-switch connections, refer to [Chapter 23, “Managing Long Distance Fabrics”](#).

## Device connection

To minimize port logins, power off all devices before connecting them to the switch. When powering the devices back on, wait for each device to complete the fabric login before powering on the next one.

For devices that cannot be powered off, first use the **portDisable** command to disable the port on the switch, connect the device, and then use the **portEnable** command to enable the port.

### Switch connection

See the hardware reference manual of your specific switch for ISL connection and cable management information. The standard or default ISL mode is L0. ISL mode L0 is a static mode, with the following maximum ISL distances:

- 10 km at 1 Gbps
- 5 km at 2 Gbps
- 2.5 km at 4 Gbps
- 1 km at 8 Gbps
- 1 km at 10 Gbps
- 1 km at 16 Gbps

For more information on extended ISL modes, which enable long distance inter-switch links, refer to [Chapter 23, “Managing Long Distance Fabrics”](#).



# Performing Advanced Configuration Tasks

---

## In this chapter

- [PIDs and PID binding overview](#) . . . . . 35
- [Ports](#) . . . . . 39
- [Blade terminology and compatibility](#) . . . . . 44
- [Enabling and disabling blades](#) . . . . . 48
- [Blade swapping](#) . . . . . 50
- [Power management](#) . . . . . 53
- [Equipment status](#) . . . . . 54
- [Track and control switch changes](#) . . . . . 55
- [Audit log configuration](#) . . . . . 58
- [Configuring FLOGI-time handling of duplicate PWWN](#) . . . . . 60

## PIDs and PID binding overview

Port identifiers (*PIDs*, also called *Fabric Addresses*) are used by the routing and zoning services in Fibre Channel fabrics to identify ports in the network. All devices in a fabric must use the same PID format. When you add new equipment to the SAN, you might need to change the PID format on legacy equipment.

Many scenarios cause a device to receive a new PID; for example, unplugging the device from one port and plugging it into a different port as part of fabric maintenance, or changing the domain ID of a switch, which might be necessary when merging fabrics, or changing compatibility mode settings.

Some device drivers use the PID to map logical disk drives to physical Fibre Channel counterparts. Most drivers can either change PID mappings dynamically, also called *dynamic PID binding*, or use the WWN of the Fibre Channel disk for mapping, also called *WWN binding*.

Some older device drivers behave as if a PID uniquely identifies a device; they use *static PID binding*. These device drivers should be updated, if possible, to use WWN binding or dynamic PID binding instead, because static PID binding creates problems in many routine maintenance scenarios. Fortunately, very few device drivers still behave this way. Many current device drivers enable you to select static PID binding as well as WWN binding. You should only select static PID binding if there is a compelling reason, and only after you have evaluated the effect of doing so.

### Core PID addressing mode

Core PID is the default PID format for Brocade platforms. It uses the entire 24-bit address space of the domain, area ID, and AL\_PA to determine an object's address within the fabric.

The Core PID is a 24-bit address built from the following three 8-bit fields:

- Domain ID, written in hex and the numeric range is from 01-ee (1-239)
- Area ID, written in hex and the numeric range is from 01-ff (1-255)
- AL\_PA

For example, if a device is assigned an address of 0f1e00, the following would apply:

- 0f is the domain ID.
- 1e is the area ID.
- 00 is the assigned AL\_PA.

From this information, you can determine which switch the device resides on from the domain ID, which port the device is attached to from the area ID, and if this device is part of a loop from the AL\_PA number.

For more information on reading and converting hexadecimal, refer to [Appendix D, "Hexadecimal Conversion"](#).

### Fixed addressing mode

Fixed addressing mode is the default addressing mode used in all platforms that do not have Virtual Fabrics enabled. When Virtual Fabrics is enabled on the Brocade Backbone, fixed addressing mode is used only on the default logical switch. With fixed addressing mode enabled, each port has a fixed address assigned by the system based on the port number. This address does not change unless you choose to swap the address using the **portSwap** command.

### 10-bit addressing mode

The 10-bit addressing mode is the default mode for all the logical switches created in the Brocade Backbones. This addressing scheme is flexible to support a large number of F\_Ports. In the regular 10-bit addressing mode, the **portAddress --auto** command supports addresses from 0x00 to 0x8F.

---

#### NOTE

The default switch in the Brocade Backbones uses the fixed addressing mode.

---

The 10-bit addressing mode utilizes the 8-bit area ID and the borrowed upper two bits from the AL\_PA portion of the PID. Areas 0x00 through 0x8F use only 8 bits for the port address and support up to 256 NPIV devices. A logical switch can support up to 144 ports that can each support 256 devices. Areas 0x90 through 0xFF use an additional two bits from the AL\_PA for the port address. Therefore, these ports support only 64 NPIV devices per port.

10-bit addressing mode provides the following features:

- A PID is dynamically allocated only when the port is first moved to a logical switch and thereafter it is persistently maintained.
- PIDs are assigned in each logical switch starting with 0xFFC0, and can go to 0x8000 in the case of 64-port blades.

- Shared area limitations are removed on 48-port and 64-port blades.
- Any port on a 48-port or 64-port blade can support up to 256 NPIV devices (in fixed addressing mode, only 128 NPIV devices are supported in non-VF mode and 64 NPIV devices in VF mode on a 48-port blade).
- Any port on a 48-port blade can support loop devices.
- Any port on a 48-port or 64-port blade can support hard port zoning.
- Port index is not guaranteed to be equal to the port area ID.

## 256-area addressing mode

This configurable addressing mode is available only in a logical switch on the Brocade Backbone. In this mode, only 256 ports are supported and each port receives a unique 8-bit area address. This mode can be used in FICON environments, which have strict requirements for 8-bit area FC addresses.

There are two types of area assignment modes in the 256-area addressing mode: zero-based and port-based.

- Zero-based mode assigns areas as ports are added to the logical switch, beginning at area 0x00. When a port is assigned to a logical switch, the next free PID starting from 0x00 is assigned. This mode allows FICON customers to make use of the upper ports of a 48-port or 64-port blade. Zero-based mode is also supported on the default switch.
- Port-based mode does not support the upper 16 ports of a 48-port or 64-port blade in a logical switch. Port-based mode is not supported on the default switch.

## WWN-based PID assignment

WWN-based PID assignment is disabled by default. When the feature is enabled, bindings are created dynamically; as new devices log in, they automatically enter the WWN-based PID database. The bindings exist until you explicitly unbind the mappings through the CLI or change to a different addressing mode. If there are any existing devices when you enable the feature, you must manually enter the WWN-based PID assignments through the CLI.

This feature also allows you to configure a PID persistently using a device WWN. When the device logs in to the switch, the PID is bound to the device WWN. If the device is moved to another port in the same switch, or a new blade is hot plugged, the device receives the same PID (area) at its next login.

Once WWN-based PID assignment is enabled, you must manually enter the WWN-based PID assignments through the CLI for any existing devices.

---

### ATTENTION

When WWN-based PID assignment is enabled, the area assignment is dynamic and does not guarantee any order in the presence of static WWN-area binding or when the devices are moved around.

---

PID assignments are supported for a maximum of 4096 devices; this includes both point-to-point and NPIV devices. The number of point-to-point devices supported depends on the areas available. For example, 448 areas are available on Backbones and 256 areas are available on switches. When the number of entries in the WWN-based PID database reaches 4096 areas are used up, the oldest unused entry is purged from the database to free up the reserved area for the new FLOGI.

#### *Virtual Fabrics considerations for WWN-based PID assignment*

WWN-based PID assignment is disabled by default and is supported in the default switch on the Brocade DCX and DCX 8510 Backbone families. This feature is not supported on application blades such as the FS8-18, FX8-24, and the FCOE10-24. The total number of ports in the default switch must be 256 or less.

When the WWN-based PID assignment feature is enabled and a new blade is plugged into the chassis, the ports for which the area is not available are disabled.

#### *NPIV*

If any NPIV devices have static PIDs configured and the acquired area is not the same as the one being requested, the FDISC coming from that device is rejected and the error is noted in the RASlog.

If the NPIV device has Dynamic Persistent PID set, the same AL\_PA value in the PID is used. This guarantees NPIV devices get the same PID across reboots and AL\_PAs assigned for the device do not depend on the order in which the devices come up. For more information on NPIV, refer to [Chapter 15, "NPIV"](#).

#### *Enabling automatic PID assignment*

---

##### **NOTE**

To activate the WWN-based PID assignment, you do not need to disable the switch.

---

1. Connect to the switch and log in using an account with admin permissions.
2. Enter the **configure** command.
3. At the **Fabric Parameters** prompt, type **y**.
4. At the **WWN Based persistent PID** prompt, type **y**.
5. Press **Enter** to bypass the remaining prompts without changing them.

##### **Example of activating PID assignments**

```
Configure...
```

```
Fabric parameters (yes, y, no, n): [no] y
```

```
WWN Based persistent PID (yes, y, no, n): [no] y
```

```
System services (yes, y, no, n): [no]
```

```
ssl attributes (yes, y, no, n): [no]
```

```
rpcd attributes (yes, y, no, n): [no]
```

```
cfgload attributes (yes, y, no, n): [no]
```

```
webtools attributes (yes, y, no, n): [no]
```

```
Custom attributes (yes, y, no, n): [no]
```

```
system attributes (yes, y, no, n): [no]
```

#### *Assigning a static PID*

1. Connect to the switch and log in using an account with admin permissions.
2. Enter the **wwnAddress -bind** command to assign a 16-bit PID to a given WWN.

### *Clearing PID binding*

1. Connect to the switch and log in using an account with admin permissions.
2. Enter the **wwnAddress -unbind** command to clear the PID binding for the specified WWN.

### *Showing PID assignments*

1. Connect to the switch and log in using an account with admin permissions.
2. Based on what you want to display, enter the appropriate command:
  - **wwnAddress -show** displays the assigned WWN-PID bindings.
  - **wwnAddress -findPID wwn** displays the PID assigned to the device WWN specified.

## Ports

Because Backbones contain interchangeable port blades, their procedures differ from those for fixed-port switches. For example, fixed-port models identify ports only by the port number, while Backbones identify ports by *slot/port* notation.

---

#### **NOTE**

For detailed information about the Brocade DCX and DCX 8510 Backbone families, refer to the hardware reference manuals.

---

The different blades that can be inserted into a chassis are described as follows:

- Control processor blades (CPs) contain communication ports for system management, and are used for low-level, platform-wide tasks.
- Core blades are used for intra-chassis switching as well as interconnecting two Backbones.
- Port blades are used for host, storage, and interswitch connections.
- AP blades are used for Fibre Channel Application Services and Routing Services, FCIP, Converged Enhanced Ethernet, and encryption support.

---

#### **NOTE**

On each port blade, a particular port must be represented by both slot number and port number.

---

The Brocade DCX and DCX 8510-8 each have 12 slots that contain control processor, core, port, and AP blades:

- Slot numbers 6 and 7 contain CPs.
- Slot numbers 5 and 8 contain core blades.
- Slot numbers 1 through 4 and 9 through 12 contain port and AP blades.

The Brocade DCX-4S and DCX 8510-4 each have 8 slots that contain control processor, core, port, and AP blades:

- Slot numbers 4 and 5 contain CPs.
- Slot numbers 3 and 6 contain core blades.
- Slot numbers 1 and 2, and 7 and 8 contain port and AP blades.

When you have port blades with different port counts in the same Backbone (for example, 16-port blades and 32-port blades, or 16-port blades and 18-port blades with 16 FC ports and 2 GbE ports, or 16-port and 48-port blades), the area IDs no longer match the port numbers.

Table 6 on page 45 lists the port numbering schemes for the blades.

## Setting port names

Perform the following steps to specify a port name. For Backbones, specify the slot number where the blade is installed.

1. Connect to the switch and log in using an account with admin permissions.
2. Enter the **portName** command.

### Example of naming port 0

```
ecp:admin> portname 1/0 trunk1
```

## Port identification by slot and port number

The port number is a number assigned to an external port to give it a unique identifier in a switch.

To select a specific port in the Backbones, you must identify both the slot number and the port number using the format *slot number/port number*. No spaces are allowed between the slot number, the slash (/), and the port number.

### Example of enabling port 4 on a blade in slot 2

```
ecp:admin> portenable 2/4
```

## Port identification by port area ID

The relationship between the port number and area ID depends upon the PID format used in the fabric. When Core PID format is in effect, the area ID for port 0 is 0, for port 1 is 1, and so forth.

For 32-port blades (FC8-32, FC8-32E, FC16-32), the numbering is contiguous up to port 15; from port 16, the numbering is still contiguous, but starts with 128. For example, port 15 in slot 1 has a port number and area ID of 15; port 16 has a port number and area ID of 128; port 17 has a port number and area ID of 129.

For 48-port blades (FC8-48, FC8-48E, FC16-48), the numbering is the same as for 32-port blades for the first 32 ports on the blade. For ports 32 through 47, area IDs are not unique and port index should be used instead of area ID.

For the 64-port blade (FC8-64), the numbering is the same as for 32-port blades for the first 32 ports on the blade. For ports 32 through 64, area IDs are not unique and port index should be used instead of area ID.

If you perform a port swap operation, the port number and area ID no longer match. On 48-port blades, port swapping is supported only on ports 0–15.

To determine the area ID of a particular port, enter the **switchShow** command. This command displays all ports on the current (logical) switch and their corresponding area IDs.

## Port identification by index

With the introduction of 48-port blades, indexing was introduced. Unique area IDs are possible for up to 255 areas, but beyond that there needed to be some way to ensure uniqueness.

A number of fabric-wide databases supported by Fabric OS (including ZoneDB, the ACL DDC, and Admin Domain) allow a port to be designated by the use of a “D,P” (*domain,port*) notation. While the “P” component appears to be the port number, for up to 255 ports it is actually the *area* assigned to that port.

---

### ATTENTION

Port area schema does not apply to the Brocade DCX-4S and DCX 8510-4 Backbones.

---

If two ports are changed using the **portSwap** command, their respective areas and “P” values are exchanged.

For ports that are numbered above 255, the “P” value is actually a logical index. The first 256 ports continue to have an index value equal to the area ID assigned to the port. If a switch is using Core PID format, and no port swapping has been done, the port index value for all ports is the same as the physical port numbers. Using **portSwap** on a pair of ports will exchange those ports’ area ID and index values.

---

### NOTE

The **portSwap** command is not supported for ports above 256.

---

## Swapping port area IDs

If a device that uses port binding is connected to a port that fails, you can use port swapping to make another physical port use the same PID as the failed port. The device can then be plugged into the new port without the need to reboot the device.

Use the following procedure to swap the port area IDs of two physical switch ports. In order to swap port area IDs, the port swap feature must be enabled, and both switch ports must be disabled. The swapped area IDs for the two ports remain persistent across reboots, power cycles, and failovers.

**Brocade DCX and DCX 8510 Backbone families only:** You can swap only ports 0 through 15 on the FC8-48 port blades. You cannot swap ports 16 through 47.

1. Connect to the switch and log in using an account with admin permissions.
2. Enable the **portSwapEnable** command to enable the feature.
3. Enter the **portDisable** command on each of the source and destination ports to be swapped.

```
switch:admin>portdisable 1
ecp:admin>portdisable 1/2
```

4. Enter the **portSwap** command.

```
switch:admin>portswap 1 2
ecp:admin>portswap 1/1 2/2
```

5. Enter the **portSwapShow** command to verify that the port area IDs have been swapped.  
A table shows the physical port numbers and the logical area IDs for any swapped ports.
6. Enter the **portSwapDisable** command to disable the port swap feature.

## Port activation and deactivation

By default, all licensed ports are enabled. You can disable and re-enable them as necessary. Ports that you activate with the Ports on Demand license must be enabled explicitly, as described in “Ports on Demand” on page 385.

If ports are persistently disabled and you use the **portEnable** command to enable a disabled port, the port will revert to being disabled after a power cycle or a switch reboot. To ensure the port remains enabled, use the **portCfgPersistentEnable** command as shown in the following instructions.



### CAUTION

The fabric will be reconfigured if the port you are enabling or disabling is connected to another switch.

The switch with a port that has been disabled will be segmented from the fabric and all traffic flowing between it and the fabric will be lost.

### *Enabling a port*

1. Connect to the switch and log in using an account with admin permissions.
2. Enter the appropriate command based on the current state of the port and on whether it is necessary to specify a slot number:
  - To enable a port that is disabled, enter the command **portEnable portnumber** or **portEnable slotnumber/portnumber**.
  - To enable a port that is persistently disabled, enter the command **portCfgPersistentEnable portnumber** or **portCfgPersistentEnable slotnumber/portnumber**.

If you change port configurations during a switch failover, the ports may become disabled. To bring the ports online, re-issue the **portEnable** command after the failover is complete.

### *Disabling a port*

1. Connect to the switch and log in using an account with admin permissions.
2. Enter the appropriate command based on the current state of the port and on whether it is necessary to specify a slot number:
  - To disable a port that is enabled, enter the command **portDisable portnumber** or **portDisable slotnumber/portnumber**.
  - To disable a port that is persistently enabled, enter the command **portCfgPersistentDisable portnumber** or **portCfgPersistentDisable slotnumber/portnumber**.



## Port decommissioning

Fabric OS 7.0.0 and later provides an automated mechanism to remove an E\_Port or E\_Port trunk port from use. This feature identifies the target port and communicates the intention to decommission the port to those systems within the fabric affected by the action. Each affected system can agree or disagree with the action, and these responses are automatically collected before a port is decommissioned.

Note that all members of a trunk group must have an equal link cost value in order for any of the members to be decommissioned. If any member of a trunk group does not have an equal cost, requests to decommission a trunk member will fail and an error reminding the caller of this requirement is produced.

Note the following restrictions of port decommissioning:

- The local switch and the remote switch on the other end of the E\_Port must both be running Fabric OS 7.0.0 or later.
- Port decommissioning is not supported on links configured for encryption or compression.
- Port decommissioning is not supported on ports with DWDM, CWDM, or TDM.
- Port decommissioning requires that the lossless feature is enabled on both the local switch and the remote switch.

Use the **portDecom** *[slot/]port* command to begin the decommission process.

## Setting port speeds

1. Connect to the switch and log in using an account with admin permissions.
2. Enter the **portCfgSpeed** command.

### Example of setting the port speed

The following example sets the speed for port 3 on slot 2 to 4 Gbps:

```
ecp:admin> portcfgspeed 2/3 4
done.
```

The following example sets the speed for port 3 on slot 2 to autonegotiate:

```
ecp:admin> portcfgspeed 2/3 0
done.
```

---

### NOTE

For the FR4-18i blade, the maximum speed supported is 4 Gbps.

---

## Setting the same speed for all ports on the switch

1. Connect to the switch and log in using an account with admin permissions.
2. Enter the **switchCfgSpeed** command.

### Example of setting the switch speed

The following example sets the speed for all ports on the switch to 8 Gbps:

```
switch:admin> switchcfgspeed 8
Committing configuration...done.
```

### 3 Blade terminology and compatibility

The following example sets the speed for all ports on the switch to autonegotiate:

```
switch:admin> switchcfgspeed 0  
Committing configuration...done.
```

## Setting port speed for a port octet

You can use the `portCfgOctetSpeedCombo` command to configure the speed for a port octet. Note that in a Virtual Fabrics environment, this command applies chassis-wide and not just to the logical switch.

1. Connect to the switch and log in using an account with admin permissions.
2. Enter the `portCfgOctetSpeedCombo` command.

### Example

The following example configures the ports in the first octet for combination 3 (support autonegotiated or fixed port speeds of 16 Gbps and 10 Gbps):

```
switch::admin> portcfgoctetspeedcombo 1 3
```

## Blade terminology and compatibility

Before configuring a chassis, familiarize yourself with the platform CP blade and port blade nomenclature, as well as the port blade compatibilities. [Table 5](#) includes core and CP blade terminology and descriptions. [Table 6](#) on page 45 includes port blade terminology and descriptions.

**TABLE 5 Core and CP blade terminology and platform support**

Blade	Blade ID (slotshow)	Supported on:		Definition
		DCX family	DCX 8510 family	
CP8	50	Yes	Yes	Brocade DCX and DCX 8510 Backbone family control processor blade. This CP supports all blades used in the DCX and DCX 8510 Backbone families.
CORE8	52	Yes DCX only	No	A 16-port blade that provides 8 Gbps connectivity between port blades in the Brocade DCX chassis.
CR4S-8	46	Yes DCX-4S only	No	A 16-port blade that provides 8 Gbps connectivity between port blades in the Brocade DCX-4S chassis.
CR16-8	98	No	Yes DCX 8510-8 only.	A core blade that has 16x4 QSFPs per blade. It can be connected to another CR16-8 or CR16-4 core blade.
CR16-4	99	No	Yes DCX 8510-4 only	A core blade that has 8x4 QSFPs per blade. It can be connected to another CR16-4 or a CR16-8 core blade.

**TABLE 6** Port blade terminology, numbering, and platform support

Blade	Blade ID (slotshow)	Supported on:		Ports	Definition
		DCX family	DCX 8510 family		
FC8-16 <sup>1</sup>	21	Yes	No	16	8-Gbps port blade supporting 1, 2, 4, and 8 Gbps port speeds. Ports are numbered from 0 through 15 from bottom to top.
FC8-32 <sup>1</sup>	55	Yes	No	32	8-Gbps port blade supporting 1, 2, 4, and 8 Gbps port speeds. Ports are numbered from 0 through 15 from bottom to top on the left set of ports and 16 through 31 from bottom to top on the right set of ports.
FC8-32E	125	No	Yes	32	8-Gbps port blade supporting 2, 4, and 8 Gbps port speeds. Ports are numbered from 0 through 15 from bottom to top on the left set of ports and 16 through 31 from bottom to top on the right set of ports.
FC8-48 <sup>1</sup>	51	Yes	No	48	8-Gbps port blade supporting 1, 2, 4, and 8 Gbps port speeds. Ports are numbered from 0 through 23 from bottom to top on the left set of ports and 24 through 47 from bottom to top on the right set of ports.
FC8-48E	126	No	Yes	48	8-Gbps port blade supporting 2, 4, and 8 Gbps port speeds. Ports are numbered from 0 through 23 from bottom to top on the left set of ports and 24 through 47 from bottom to top on the right set of ports.
FC8-64	77	Yes	Yes	64	8-Gbps port blade supporting 2, 4, and 8 Gbps port speeds. The Brocade DCX and Brocade DCX 8510 Backbone families support loop devices on 64-port blades in a Virtual Fabric-enabled environment. The loop devices can only be attached to ports on a 64-port blade that is not a part of the default logical switch. Ports are numbered from 0 through 31 from bottom to top on the left set of ports and 32 through 63 from bottom to top on the right set of ports.
FC10-6	39	Yes	No	6	A 6-port, 10-Gbps port blade supporting 10 Gbps port speed. Blade provides 10 Gbps ISLs. This port blade can be used to form ISLs only between other FC10-6 ports. Ports are numbered from 0 through 5 from bottom to top.
FC16-32	97	No	Yes	32	A 32-port, 16-Gbps port blade supporting 2, 4, 8, 10, and 16 Gbps port speeds. <b>NOTE:</b> 10 Gbps speed for FC16-xx blades requires the 10G license. Ports are numbered from 0 through 15 from bottom to top on the left set of ports and 16 through 31 from bottom to top on the right set of ports.

### 3 Blade terminology and compatibility

**TABLE 6 Port blade terminology, numbering, and platform support (Continued)**

Blade	Blade ID (slotshow)	Supported on:		Ports	Definition
		DCX family	DCX8510 family		
FC16-48	96	No	Yes	48	<p>A 48-port, 16-Gbps port blade supporting 2, 4, 8, 10, and 16 Gbps port speeds.</p> <p><b>NOTE:</b> 10 Gbps speed for FC16-xx blades requires the 10G license.</p> <p>Ports are numbered from 0 through 23 from bottom to top on the left set of ports and 24 through 47 from bottom to top on the right set of ports.</p>
FR4-18i	24	Yes	No	16 FC 2 GbE	<p>Fibre Channel routing and FCIP blade supporting 2 and 4 Gbps port speeds.</p> <p>FC ports are numbered from 0 through 15 from bottom to top.</p> <p>GbE ports are numbered ge0 through ge1 from bottom to top.</p> <p>Going from bottom to top, the 2 GbE ports appear on the bottom of the blade followed by 16 FC ports.</p>
FS8-18	68	Yes	Yes	16 FC 2 GbE	<p>Brocade Encryption blade that provides high performance 32-port auto-sensing 8-Gbps Fibre Channel connectivity with data cryptographic (encryption/decryption) and data compression capabilities.</p> <p>Ports are numbered from 0 through 15 from bottom to top.</p> <p>GbE ports are numbered ge0 through ge1 from top to bottom.</p> <p>Going from top to bottom, the 2 GbE ports appear on the top of the blade followed by the 16 FC ports.</p>
FCOE10-24	74	Yes	No	24 10-GbE DCB ports	<p>An application blade that provides Converged Enhanced Ethernet to bridge a Fibre Channel and Ethernet SAN.</p> <p>Ports are numbered from 0 through 11 from bottom to top on the left set of ports and 12 through 23 from bottom to top on the right set of ports.</p>
FX8-24	75	Yes	Yes	12 FC 10 1-GbE 2 10-GbE	<p>Extension blade with 8-Gbps Fibre Channel, FCIP, and 10-GbE technology.</p> <p>Port numbering on this blade is as follows.</p> <p>On the left side of the blade going from bottom to top:</p> <ul style="list-style-type: none"> <li>• Six FC ports numbered from 0 through 5</li> <li>• Two 10-GbE ports numbered xge0 and xge1</li> <li>• Four 1-GbE ports numbered from ge0 through ge3</li> </ul> <p>On the right side of the blade going from bottom to top:</p> <ul style="list-style-type: none"> <li>• Six FC ports numbered from 6 through 11</li> <li>• Six 1-GbE ports numbered from ge4 through ge9</li> </ul>

1. The Brocade DCX and DCX-4S support loop devices on this blade in a Virtual Fabrics-enabled environment.

## CP blades

The control processor (CP) blade provides redundancy and acts as the main controller on the Brocade Backbone. The Brocade DCX and DCX 8510 Backbone families support the CP8 blades.

The CP blades in the Brocade DCX and DCX 8510 Backbone families are hot-swappable. The CP8 blades are fully interchangeable among Brocade DCX, DCX-4S, DCX 8510-4, and DCX 8510-8 Backbones.

Brocade recommends that each CP (primary and secondary partition) should maintain the same firmware version.

For more information on maintaining firmware in your Backbone, refer to [Chapter 9, “Installing and Maintaining Firmware”](#).

## Core blades

Core blades provide intra-chassis switching and ICL connectivity, between DCX/DCX-4S platforms and between DCX 8510 platforms.

- Brocade DCX supports two CORE8 core blades.
- Brocade DCX-4S supports two CR4S-8 core blades.
- Brocade DCX 8510-8 supports two CR16-8 core blades.
- Brocade DCX 8510-4 supports two CR16-4 core blades.

The core blades for each platform are not interchangeable or hot-swappable with the core blades for any other platform. If you try to interchange the blades they become faulty.

## Port and application blade compatibility

[Table 6](#) on page 45 identifies which port and application blades are supported for each Brocade Backbone.

---

### NOTE

The FR4-18i blade cannot coexist in the same chassis with an FX8-24 blade.

---

### NOTE

During power up of a Brocade DCX or DCX-4S Backbone, if an FCOE10-24 is detected first before any other AP blade, all other AP and FC8-64 blades are faulted. If a non-FCOE10-24 blade is detected first, then any subsequently-detected FCOE10-24 blades are faulted. Blades are powered up starting with slot 1.

---

The maximum number of intelligent blades supported on a Brocade DCX or DCX 8510-8 is eight.

The maximum number of intelligent blades supported on a Brocade DCX-4S or DCX 8510-4 is four.

[Table 7](#) lists the maximum supported limits of each blade for a specific Fabric OS release. Software functions are not supported across application blades.

**TABLE 7 Blade compatibility within Brocade Backbone families**

Intelligent blade	Fabric OS v6.3.0		Fabric OS v6.4.0		Fabric OS v7.0.0			
	DCX	DCX-4S	DCX	DCX-4S	DCX	DCX-4S	DCX 8510-8	DCX 8510-4
FR4-18i <sup>1</sup>	8	4	8	4	8	4	0	0
FS8-18	4	4	4	4	4	4	4	4
FCOE10-24 <sup>2</sup>	2	2	2	2	4	4	0	0
FX8-24 <sup>3</sup>	2	4	4	4	4	4	4	4

1. The iSCSI function over FCIP is not supported, but the FCIP link is the same as other FC E\_Ports. This is not restricted by software.
2. Not compatible with other application blades or with the FC8-64 in the same chassis.
3. The hardware limit is enforced by software.

## FX8-24 compatibility notes

Note the following guidelines when using the FX8-24 in the Brocade DCX and DCX-4S Backbones:

- The FR4-18i and Brocade 7500 GbE ports cannot be connected to either the FX8-24 or Brocade 7800 GbE ports. The ports may come online, but they will not communicate with each other. Running physical cables between the FR4-18i and FX8-24 blades is not supported.
- The port configuration is maintained separately for the GbE ports of the FR4-18i and FX8-24 blades. The port configuration data of one blade is never applied to the other type even if an FX8-24 replaces an FR4-18i in the same slot of a chassis. However, if an FR4-18i blade is replaced with an FX8-24 blade and then replaced back with an FR4-18i, the FR4-18i previous IP configuration data would be applied to the new FR4-18i. The same behavior applies if you were to replace the FX8-24 with an FX8-24.
- When Virtual Fabrics is disabled, replacing an FR4-18i with an FX8-24 (and vice-versa) is allowed without any pre-conditions
- When Virtual Fabrics is enabled (regardless of whether the FR4-18i or FX8-24 blade is in the default switch), replacing an FR4-18i with an FX8-24 (and vice-versa) without rebooting or power cycling the chassis will fault the blade with reason code 91. However, after blade removal, if you reboot or power cycle the chassis, inserting the other blade type is allowed.
- The data paths in both blades are interoperable between FC ports. FR4-18i FC ports can stream data over FX8-24 GbE ports and vice versa.
- The FX8-24 and FS8-18 blades cannot co-exist with the FCOE10-24 blade.

## Enabling and disabling blades

Port blades are enabled by default. In some cases, you will need to disable a port blade to perform diagnostics. When diagnostics are executed manually (from the Fabric OS command line), many commands require the port blade to be disabled. This ensures that diagnostic activity does not interfere with normal fabric traffic.

If you need to replace an application blade with a different application blade, there may be extra steps you need to take to ensure that the previous configuration is not interfering with your new application blade.

## Enabling blades

1. Connect to the switch and log in using an account with admin permissions.
2. Enter the **bladeEnable** command with the slot number of the port blade you want to enable.

```
ecp:admin> bladeenable 3
Slot 3 is being enabled
```

### *FC8-48, FC8-48E, FC8-64, and FC16-48 port blade enabling exceptions*

Because the area IDs are shared with different port IDs, the FC8-48, FC8-48E, FC8-64, and FC16-48 blades support only F\_ and E\_Ports. They do not support FL\_Ports.

Port swapping on an FC8-48, FC8-48E, FC8-64, and FC16-48 is supported only on ports 0–15. For the FC8-32, FC8-32E, and FC16-32 port blades, port swapping is supported on all 32 ports. This means that if you replace a 32-port blade where a port has been swapped on ports 16–31 with a 48-port blade, the 48-port blade faults. To correct this, reinsert the 32-port blade and issue **portSwap** to restore the original area IDs to ports 16–31.

### *FR4-18i application blade enabling exceptions*

Note the following exceptions to enabling the FR4-18i application blade:

- You have inserted the FR4-18i blade into a slot that was previously empty or contained an FC8-16, FC8-32, FC8-48, FC10-6, FS8-18.

If the FR4-18i blade is operational and the platform is rebooted, then after the successful bootup of the system the blade continues operations using the previous configurations.

If a previously configured FR4-18i blade is removed and another or the same FR4-18i blade is inserted into the same slot, then the ports use the previous configuration and come up enabled. If you do not want to use the previous configuration, you must clear the configuration information, remove the blade, and then reseal the blade.

If a previously-configured FR4-18i blade is removed and an FC8-16, FC8-32, FC8-48, or FC10-6 blade is plugged in, then—other than the port's EX\_Port configuration—all the remaining port configurations previously applied to the FR4-18i ports can be used. The EX\_Port configuration on those ports is disabled before the FC8 port blade becomes operational. When a blade is present in the slot, then any requested port configuration is validated against the blade's capabilities before accepting the request. Also, hot-swapping causes the ports on the FR4-18i to be persistently disabled (which later need to be enabled).

- If you have turned on the power to the chassis and the FR4-18i blade in that slot was not active prior to the power-on you must persistently enable the ports manually. For instructions on how to manually persistently enable a port, refer to [“Port activation and deactivation”](#) on page 42.

---

#### **ATTENTION**

The ports of an FR4-18i are persistently disabled only if an FR4-18i was not previously in that slot. You can replace an FR4-18i with another one with no change in the port states.

---

To summarize:

- When an FC8-16, FC8-32, FC10-6, FS8-18, or FX8-24 blade is replaced by an FR4-18i blade, the current port configuration continues to be used, and all ports on the FR4-18i blade are persistently disabled.

## 3 Blade swapping

- When an FR4-18i blade is replaced by an FC8-16, FC8-32, FC8-48, or FC8-64 blade, then the EX\_Port configuration is retained, but the ports are persistently disabled. All remaining port configurations are retained.

---

**NOTE**

The FC10-6 blade does not support EX\_Ports.

---

### Disabling blades

1. Connect to the switch and log in using an account with admin permissions.
2. Enter the **bladeDisable** command with the slot number of the port blade you want to disable.

```
ecp:admin> bladedisable 3  
Slot 3 is being disabled
```

## Blade swapping

Blade swapping allows you to swap one blade with another of the same type; in this way, you can replace a FRU with minimal traffic disruption. The entire operation is accomplished when the **bladeSwap** command runs on the Fabric OS. The Fabric OS then validates each command before actually implementing the command on the Backbone. If an error is encountered, the blade swap quits without disrupting traffic flowing through the blades. If an unforeseen error does occur during the **bladeSwap** command, an entry will be made into the RASlog and all ports that have been swapped as part of the blade swap operation will be swapped back. On successful completion of the command, the source and destination blades are left in a disabled state, allowing you to complete the cable move.

Blade swapping is based on port swapping and has the same restrictions:

- Shared area ports cannot be swapped.
- Ports that are part of a trunk group cannot be swapped.
- GbE ports cannot be swapped.
- Swapping ports between different logical switches is not supported. The ports on the source and destination blades must be in the same logical switch.
- Undetermined board types cannot be swapped. For example, a blade swap will fail if the blade type cannot be identified.
- Blade swapping is not supported when swapping to a different model of blade or a different port count. For example, you cannot swap an FC8-32 blade with an FC8-48 port blade.

---

**NOTE**

This feature is not supported on the FX8-24 DCX Extension blade.

---



## How blades are swapped

The `bladeSwap` command performs the following operations:

### 1. Blade selection

The selection process includes selecting the switch and the blades to be affected by the swap operation. [Figure 2](#) shows the source and destination blades identified to begin the process.

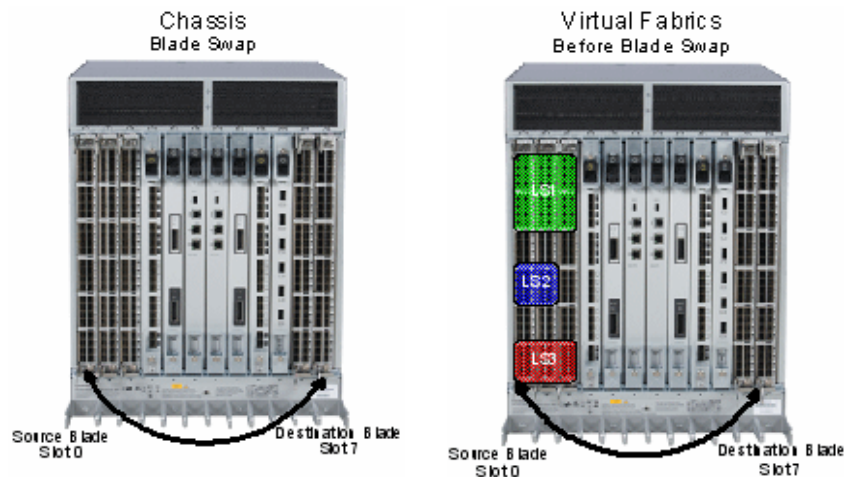

**FIGURE 2** Identifying the blades

### 2. Blade validation

The validation process includes determining the compatibility between the blades selected for the swap operation:

- Blade technology. Both blades must be of compatible technology types (for example, Fibre Channel to Fibre Channel, Ethernet to Ethernet, application to application, and so on).
- Port count. Both blades must support the same number of front ports (for example, 16 ports to 16 ports, 32 ports to 32 ports, 48 ports to 48 ports, and so on).
- Availability. The ports on the destination blade must be available for the swap operation and not attached to any other devices.

### 3. Port preparation

The process of preparing ports for a swap operation includes basic operations such as ensuring the source and destination ports are offline, or verifying that none of the destination ports have failed.

The preparation process also includes any special handling of ports associated with logical switches. For example [Figure 3](#) shows the source blade has ports in a logical switch or logical fabric, then the corresponding destination ports must be included in the associated logical switch or logical fabric of the source ports.

### 3 Blade swapping

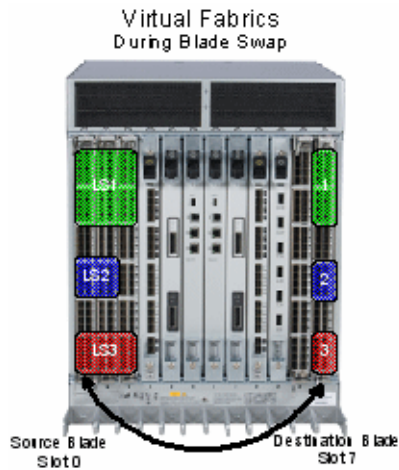

FIGURE 3 Blade swap with Virtual Fabrics during the swap

#### 4. Port swapping

The swap ports action is effectively an iteration of the **portSwap** command for each port on the source blade to each corresponding port on the destination blade.

In Figure 4 shows Virtual Fabrics, where the blades can be carved up into different logical switches as long as they are carved the same way. If slot 1 and slot 2 ports 0-7 are all in the same logical switch, then blade swapping slot 1 to slot 2 will work. The entire blade does not need to be in the same partition.

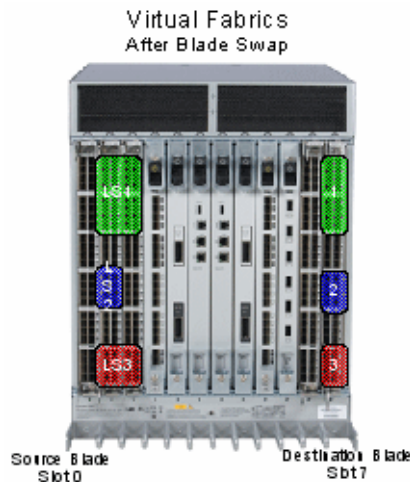

FIGURE 4 Blade swap with Virtual Fabrics after the swap

## Swapping blades

1. Connect to the Backbone and log in using an account with admin permissions.
2. Enter the **bladeSwap** command.

If no errors are encountered, the blade swap will complete successfully. If errors are encountered, the command is interrupted and the ports are set back to their original configurations.

3. Once the command completes successfully, move the cables from the source blade to the destination blade.
4. Enter the **bladeEnable** command on the destination blade to enable all user ports.

## Power management

All blades are powered on by default when the switch chassis is powered on. Blades cannot be powered off when POST or AP initialization is in progress.

To manage power and ensure that more critical components are the least affected by power changes, you can specify the order in which the components are powered off, using the **powerOffListSet** command

The power monitor compares the available power with the power required to determine if there will be enough power to operate. If it is predicted to be less power available than required, the power-off list is processed until there is enough power for operation. By default, the processing begins with slot 1 and proceeds to the last slot in the chassis. As power becomes available, slots are powered up in the reverse order. During the initial power up of a chassis, or using the **slotPowerOn** command, or the insertion of a blade, the available power is compared to required power before power is applied to the blade.

---

### NOTE

Some FRUs in the chassis may use significant power, yet cannot be powered off through software.

---

The **powerOffListShow** command displays the power off order.

---

### NOTE

In the Backbones, the core blades and CP blades cannot be powered off from the CLI. You must manually power off the blades by lowering the slider or removing power from the chassis. If there is no CP up and running, then physical removal or powering off the chassis is required.

---

## Powering off a port blade

1. Connect to the switch and log in using an account with admin permissions.
2. Enter the **slotPowerOff** command with the slot number of the port blade you want to power off.

```
ecp:admin> slotpoweroff 3  
Slot 3 is being powered off
```

## Powering on a port blade

1. Connect to the switch and log in using an account with admin permissions.
2. Enter the **slotPowerOn** command with the slot number of the port blade you want to power on.

```
ecp:admin> slotpoweron 3  
Powering on slot 3
```

## Equipment status

You can check the status of switch operation, High Availability features, and fabric connectivity.

### Checking switch operation

1. Connect to the switch and log in using an account with admin permissions.
2. Enter the **switchShow** command. This command displays a switch summary and a port summary.
3. Check that the switch and ports are online.
4. Use the **switchStatusShow** command to further check the status of the switch.

### Verifying High Availability features (Backbones only)

High Availability (HA) features provide maximum reliability and nondisruptive management of key hardware and software modules.

1. Connect to the switch and log in using an account with admin permissions.
2. Enter the **chassisShow** command to verify the model of the DCX and obtain a listing of all field-replaceable units (FRUs).
3. Enter the **haShow** command to verify HA is enabled, the heartbeat is up, and that the HA state is synchronized between the active and standby CP blades.
4. Enter the **fanShow** command to display the current status and speed of each fan in the system. Refer to the hardware reference manual of your system to determine the appropriate values.
5. Enter the **psShow** command to display the current status of the switch power supplies. Refer to the hardware reference manual of your system to determine the appropriate values.
6. Enter the **slotShow -m** command to display the inventory and the current status of each slot in the system.

#### Example of the slot information displayed for a DCX chassis

```
DCX:FID128:admin> slotshow -m
```

Slot	Blade Type	ID	Model Name	Status
1	SW BLADE	55	FC8-32	ENABLED
2	SW BLADE	51	FC8-48	ENABLED
3	SW BLADE	39	FC10-6	ENABLED
4	SW BLADE	51	FC8-48	ENABLED
5	CORE BLADE	52	CORE8	ENABLED
6	CP BLADE	50	CP8	ENABLED
7	CP BLADE	50	CP8	ENABLED
8	CORE BLADE	52	CORE8	ENABLED
9	SW BLADE	37	FC8-16	ENABLED
10	AP BLADE	43	FS8-18	ENABLED
11	SW BLADE	55	FC8-32	ENABLED
12	AP BLADE	24	FR4-18i	ENABLED

## Verifying fabric connectivity

1. Connect to the switch and log in using an account with admin permissions.
2. Enter the **fabricShow** command. This command displays a summary of all the switches in the fabric.

The output of the **fabricShow** command is discussed in “Domain IDs” on page 28.

## Verifying device connectivity

1. Connect to the switch and log in using an account with admin permissions.
2. *Optional:* Enter the **switchShow** command to verify devices, hosts, and storage are connected.
3. *Optional:* Enter the **nsShow** command to verify devices, hosts, and storage have successfully registered with the name server.
4. Enter the **nsAllShow** command to display the 24-bit Fibre Channel addresses of all devices in the fabric.

```
switch:admin> nsallshow
{
  010e00 012fe8 012fef 030500 030b04 030b08 030b17 030b18
  030b1e 030b1f 040000 050000 050200 050700 050800 050de8
  050def 051700 061c00 071a00 073c00 090d00 0a0200 0a07ca
  0a07cb 0a07cc 0a07cd 0a07ce 0a07d1 0a07d2 0a07d3 0a07d4
  0a07d5 0a07d6 0a07d9 0a07da 0a07dc 0a07e0 0a07e1 0a0f01
  0a0f02 0a0f0f 0a0f10 0a0f1b 0a0f1d 0b2700 0b2e00 0b2fe8
  0b2fef 0f0000 0f0226 0f0233 0f02e4 0f02e8 0f02ef 210e00
  211700 211fe8 211fef 2c0000 2c0300 611000 6114e8 6114ef
  611600 620800 621026 621036 6210e4 6210e8 6210ef 621400
  621500 621700 621a00
  75 Nx_Ports in the Fabric }
```

The number of devices listed should reflect the number of devices that are connected.

## Track and control switch changes

The track changes feature allows you to keep a record of specific changes that may not be considered switch events, but may provide useful information. The output from the track changes feature is dumped to the system messages log for the switch. Use the **errDump** or **errShow** command to view the log.

Items in the log created from the track changes feature are labeled *TRCK*.

Trackable changes are:

- Successful login
- Unsuccessful login
- Logout
- Track changes on
- Track changes off

## Enabling the track changes feature

1. Connect to the switch and log in using an account with admin permissions.
2. Enter the **trackChangesSet 1** command to enable the track changes feature.

A message displays, verifying that the track changes feature is on:

```
switch:admin> trackchangesset 1
Committing configuration...done.
```

3. View the log using the commands **errDump | more** to display a page at a time or **errShow** to view one line at a time.

```
2008/10/10-08:13:36, [TRCK-1001], 5, FID 128, INFO, ras007, Successful login
by user admin.
```

## Displaying the status of the track changes feature

1. Connect to the switch and log in using an account with admin permissions.
2. Enter the **trackChangesShow** command.

The status of the track changes feature is displayed as either on or off. The display includes whether or not the track changes feature is configured to send SNMP traps.

```
switch:admin> trackchangesshow
Track changes status: ON
Track changes generate SNMP-TRAP: NO
```

## Viewing the switch status policy threshold values

The policy parameter determines the number of failed or inoperable units for each contributor that triggers a status change in the switch.

Each parameter can be adjusted so that a specific threshold must be reached before that parameter changes the overall status of a switch to MARGINAL or DOWN. For example, if the FaultyPorts DOWN parameter is set to 3, the status of the switch will change if three ports fail. Only one policy parameter needs to pass the MARGINAL or DOWN threshold to change the overall status of the switch.

For more information about setting policy parameters, see the *Fabric Watch Administrator's Guide*.

1. Connect to the switch and log in using an account with admin permissions.
2. Enter the **switchStatusPolicyShow** command.

Whenever there is a switch change, an error message is logged and an SNMP connUnitStatusChange trap is sent.

The output is similar to the following:

```
eyp:admin> switchstatuspolicyshow
switch:admin> switchstatuspolicyshow
  The current overall switch status policy parameters:
      Down      Marginal
-----
PowerSupplies  0          0
Temperatures   0          0
Fans           1          0
```

```

          WWN      0          0
          CP       0          0
          Blade    0          0
          CoreBlade 0          0
          Flash    0          0
MarginalPorts 0.00%[0]      0.00%[0]
FaultyPorts   0.00%[0]      0.00%[0]
MissingSFPs   0.00%[0]      0.00%[0]
ErrorPorts    0.00%[0]      0.00%[0]
Number of ports: 4

```

## Setting the switch status policy threshold values

1. Connect to the switch and log in using an account with admin permissions.
2. Enter the **switchStatusPolicySet** command.

The current switch status policy parameter values are displayed. You are prompted to enter values for each DOWN and MARGINAL threshold parameter.

---

### NOTE

By setting the DOWN and MARGINAL values for a parameter to 0,0 that parameter is no longer used in setting the overall status for the switch.

---

3. Verify the threshold settings you have configured for each parameter.

Enter the **switchStatusPolicyShow** command to view your current switch status policy configuration.

### Example output from a switch

The following example displays what is typically seen from a Brocade switch, but the quantity and types vary by platform.

```

switch:admin> switchstatuspolicyshow

To change the overall switch status policy parameters

The current overall switch status policy parameters:
          Down      Marginal
-----
PowerSupplies      2          1
Temperatures       2          1
    Fans           2          1
    Flash          0          1
MarginalPorts     25.00%[12]      10.00%[5]
FaultyPorts       25.00%[12]      10.00%[5]
MissingSFPs       0.00%[0]        0.00%[0]
ErrorPorts        0.00%[0]        0.00%[0]
Number of ports: 48

```

Note that the value, 0, for a parameter, means that it is NOT used in the calculation.

\*\* In addition, if the range of settable values in the prompt is (0..0),  
 \*\* the policy parameter is NOT applicable to the switch.  
 \*\* Simply hit the Return key.

The minimum number of

```
Bad PowerSupplies contributing to DOWN status: (0..2) [2]
```

### 3 Audit log configuration

```
Bad PowerSupplies contributing to MARGINAL status: (0..2) [1]
Bad Temperatures contributing to DOWN status: (0..4) [2]1
Bad Temperatures contributing to MARGINAL status: (0..4) [1]2
Bad Fans contributing to DOWN status: (0..2) [2]
Bad Fans contributing to MARGINAL status: (0..2) [1]
(output truncated)
```

On the Brocade Backbones, the command output includes parameters related to CP blades.

## Audit log configuration

When managing SANs you may want to audit certain classes of events to ensure that you can view and generate an audit log for what is happening on a switch, particularly for security-related event changes. These events include login failures, zone configuration changes, firmware downloads, and other configuration changes; in other words, critical changes that have a serious effect on the operation and security of the switch.

Important information related to event classes is also tracked and made available. For example, you can track changes from an external source by the user name, IP address, or type of management interface used to access the switch.

Auditable events are generated by the switch and streamed to an external host through a configured system message log daemon (syslog). You specify a filter on the output to select the event classes that are sent through the system message log. The filtered events are streamed chronologically and sent to the system message log on an external host in the specified audit message format. This ensures that they can be easily distinguished from other system message log events that occur in the network. Then, at some regular interval of your choosing, you can review the audit events to look for unexpected changes.

Before you configure audit event logging, familiarize yourself with the following audit event log behaviors and limitations:

- By default, *all event classes* are configured for audit; to create an audit event log *for specific events*, you must explicitly set a filter with the *class* operand and then enable it.
- Audited events are generated specific to a switch and have no negative impact on performance.
- The last 256 events are persistently stored on the switch and are streamed to a system message log.
- The audit log depends on the system message log facility and IP network to send messages from the switch to a remote host. Because the audit event log configuration has no control over these facilities, audit events can be lost if the system message log and IP network facilities fail.
- If too many events are generated by the switch, the system message log becomes a bottleneck and audit events are dropped by the Fabric OS.
- If the user name, IP address, or user interface is not transported, *None* is used instead for each of the respective fields.
- For High Availability, the audit event logs exist independently on both active and standby CPs. The configuration changes that occur on the active CP are propagated to the standby CP and take effect.
- Audit log configuration is also updated through a configuration download.

Before configuring an audit log, you must select the event classes you want audited.



---

**NOTE**

Only the active CP can generate audit messages because event classes being audited occur only on the active CP. Audit messages cannot originate from other blades in a Backbone.

---

Switch names are logged for switch components and Backbone names for Backbone components. For example, a Backbone name may be FWDL or RAS and a switch component name may be zone, name server, or SNMP.

Pushed messages contain the administrative domain of the entity that generated the event. Refer to the *Fabric OS Message Reference* for details on event classes and message formats. For more information on setting up the system error log daemon, refer to the *Fabric OS Troubleshooting and Diagnostics Guide*.

---

**NOTE**

If an AUDIT message is logged from the CLI, any environment variables will be initialized with proper values for login, interface, ip and other session information. Refer to the *Fabric OS Message Reference* for more information.

---

## Verifying host syslog prior to configuring the audit log

Audit logging assumes that your syslog is operational and running. Before configuring an audit log, you must perform the following steps to ensure that the host syslog is operational.

1. Set up an external host machine with a system message log daemon running to receive the audit events that will be generated.
2. On the switch where the audit configuration is enabled, enter the **syslogdIpAdd** command to add the IP address of the host machine so that it can receive the audit events.  
  
You can use IPv4, IPv6, or DNS names for the **syslogdIpAdd** command.
3. Ensure the network is configured with a network connection between the switch and the remote host.
4. Check the host syslog configuration. If all error levels are not configured, you may not see some of the audit messages.

## Configuring an audit log for specific event classes

1. Connect to the switch from which you want to generate an audit log and log in using an account with admin permissions.
2. Enter the **auditCfg --class** command, which defines the specific event classes to be filtered.

```
switch:admin> auditcfg --class 2,4  
Audit filter is configured.
```

3. Enter the **auditCfg --enable** command, which enables audit event logging based on the classes configured in [step 2](#).

```
switch:admin> auditcfg --enable  
Audit filter is enabled.
```

To disable an audit event configuration, enter the **auditCfg --disable** command.

### 3 Configuring FLOGI-time handling of duplicate PWWN

4. Enter the `auditCfg --show` command to view the filter configuration and confirm that the correct event classes are being audited, and the correct filter state appears (enabled or disabled).

```
switch:admin> auditcfg --show
Audit filter is enabled.
2-SECURITY
4-FIRMWARE
```

5. Issue the `auditDump -s` command to confirm that the audit messages are being generated.

#### Example of the `syslog (system message log)` output for audit logging

```
Oct 10 08:52:06 10.3.220.7 raslogd: AUDIT, 2008/10/10-08:20:19 (GMT),
[SEC-3020], INFO, SECURITY, admin/admin/10.3.220.13/telnet/CLI,
ad_0/ras007/FID 128, , Event: login, Status: success, Info: Successful login
attempt via REMOTE, IP Addr: 10.3.220.13.

Oct 10 08:52:23 10.3.220.7 raslogd: 2008/10/10-08:20:36, [CONF-1001], 13, WWN
10:00:00:05:1e:34:02:0c | FID 128, INFO, ras007, configUpload completed
successfully. All config parameters are uploaded.

Oct 10 09:00:04 10.3.220.7 raslogd: AUDIT, 2008/10/10-08:28:16 (GMT),
[SEC-3021], INFO, SECURITY, admin/NONE/10.3.220.13/None/CLI, None/ras007/FID
128, , Event: login, Status: failed, Info: Failed login attempt via REMOTE, IP
Addr: 10.3.220.13.
```

## Configuring FLOGI-time handling of duplicate PWWN

Fabric OS has two configurable options for handling duplicate PWWN conflicts occurring on the same switch.

- Existing login takes precedence over second login (default behavior).
- Second login overrides existing login (optional behavior).

[Table 8](#) shows details of the default behavior. [Table 9](#) shows details of the optional behavior.

**TABLE 8 Duplicate PWWN behavior: Existing login takes precedence over second login**

Input port	Duplicate found on same F_Port	Duplicate found on different F_Port	Duplicate found on same NPIV port	Duplicate found on different NPIV port
FLOGI received	1	Implicit logout.	1	Send FLOGI RJT.
	2	Send FLOGI ACC.	2	RASLog Duplicate Found.
			3	Persistently disable input port.
FDISC received	N/A	1	Send FDISC RJT.	Send FDISC ACC with previously assigned PID.
		2	RASLog Duplicate Found.	2

**TABLE 9 Duplicate PWWN behavior: Second login overrides existing login**

Input port	Duplicate found on same F_Port	Duplicate found on different F_Port	Duplicate found on same NPIV port	Duplicate found on different NPIV port
FLOGI received	1 Implicit logout. 2 Send FLOGI ACC.	1 Logout different F-port. 2 Persistently disable different F-port. 3 RASLog Duplicate Found. 4 FLOGI ACC to Input port.	N/A	1 Logout duplicate on different NPIV port. 2 RASLog Duplicate Found. 3 FLOGI ACC to input port.
FDISC received	N/A	1 Logout different F-port. 2 Persistently disable different F-port. 3 RASLog Duplicate Found. 4 FDISC ACC to Input port.	Send FDISC ACC with previously assigned PID	1 Logout duplicate on different NPIV port. 2 RASLog Duplicate Found. 3 FDISC ACC to input port.

## Setting the behavior for handling duplicate PWWNs

1. Connect to the switch and log in using an account with admin permissions.
2. Enter the **switchDisable** command to disable the switch.
3. Enter the **configure** command.
4. Enter **y** after the F-Port login parameters prompt.

```
F-Port login parameters (yes, y, no, n): [no] y
```

5. Enter **1** at the Enforce FLOGI/FDISC login prompt to select the optional behavior for handling duplicate PWWNs.

```
Enforce FLOGI/FDISC login: (0..1) [0] 1
```

Enter **0** at the Enforce FLOGI/FDISC login prompt to select the default behavior.

6. Respond to the remaining prompts, or press Ctrl-D to accept the other settings and exit.
7. Enter the **switchEnable** command to re-enable the switch.

With either setting, detection of duplicate PWWNs results in a RASLog. Ports that are restricted become persistently disabled, marked with the reason "Duplicate Port WWN detected".

### 3 Configuring FLOGI-time handling of duplicate PWWN

# Routing Traffic

---

## In this chapter

• Routing overview .....	63
• Inter-switch links .....	66
• Gateway links .....	68
• Routing policies .....	70
• Route selection .....	72
• Frame order delivery .....	74
• Lossless Dynamic Load Sharing on ports .....	75
• Enabling forward error correction .....	77
• Frame Redirection .....	78

## Routing overview

Data moves through a fabric from switch to switch and from storage to server along one or more paths that make up a *route*. Routing policies determine the path for each frame of data.

Before the fabric can begin routing traffic, it must discover the route a packet should take to reach the intended destination. Route tables are lists that indicate the next hop to which packets are directed to reach a destination. Route tables include network addresses, the next address in the data path, and a cost to reach the destination network. There are two kinds of routing protocols on intranet networks, distance vector and link state.

- Distance vector is based on hop count. This is the number of switches that a frame passes through to get from the source switch to the destination switch.
- Link state is based on a metric value based on a cost. The cost could be based on bandwidth, line speed, or round-trip time.

With the link-state protocol, switches that discover a route identify the networks to which they are attached, receiving an initial route table from the principal switch. After an initial message is sent out, the switch only notifies the others when changes occur.

It is recommended that no more than seven hops occur between any two switches. This limit is not required or enforced by Fabric Shortest Path First (FSPF). Its purpose is to ensure that a frame is not delivered to a destination after Resource Allocation TimeOut Value (R\_A\_TOV) has expired.

Fabric OS v7.0.1 supports unicast Class 2 and 3 traffic, multicast, and broadcast traffic. Broadcast and multicast are supported in Class 3 only.



---

**NOTE**

FSPF only supports 16 routes in a zone, including Traffic Isolation Zones.

---

FSPF makes minimal use of the ISL bandwidth, leaving virtually all of it available for traffic. In a stable fabric, a switch transmits 64 bytes every 20 seconds in each direction. FSPF frames have the highest priority in the fabric. This guarantees that a control frame is not delayed by user data and that FSPF routing decisions occur very quickly during convergence.

FSPF guarantees a routing loop-free topology at all times. It is essential for a fabric to include many physical loops because, without loops, there would be no multiple paths between switches, and therefore no redundancy. If a link goes down, part of the fabric becomes isolated. FSPF ensures that the topology is loop-free and that the frame is never forwarded over the same ISL more than once.

FSPF calculates paths based on the destination domain ID. The fabric protocol must complete domain ID assignments before routing can begin. ISLs provide the physical pathway when the Source ID (SID) address has a frame destined to a port on a remote switch Destination ID (DID). When an ISL is attached or removed from a switch, the FSPF updates the route tables to reflect the addition or deletion of the new routes.

As each host transmits a frame to the switch, the switch reads the SID and DID in the frame header. If the domain ID of the destination address is the same as the switch (intra-switch communications), the frame buffer is copied to the destination port and a credit R\_RDY message is sent to the host. The switch only needs to read word zero and word one of the Fibre Channel frame to perform what is known as *cut-through routing*. A frame may begin to emerge from the output port before it has been entirely received by the input port. The entire frame does not need to be buffered in the switch.

If the destination domain ID is different than the source domain ID, then the switch consults the FSPF route table to identify which local E\_Port provides the Fabric Shortest Path First (FSPF) to the remote domain.

## Fibre Channel NAT

Within an edge fabric or across a backbone fabric, the standard Fibre Channel FSPF protocol determines how frames are routed from the source Fibre Channel (FC) device to the destination FC device. The source or destination device can be a proxy device.

Fibre Channel fabrics require that all ports be identified by a unique port identifier (PID). In a single fabric, FC protocol guarantees that domain IDs are unique, and so a PID formed by a domain ID and area ID is unique within a fabric. However, the domain IDs and PIDs in one fabric may be duplicated within another fabric, just as IP addresses that are unique to one private network are likely to be duplicated within another private network.

In an IP network, a network router can maintain network address translation (NAT) tables to replace private network addresses with public addresses when a packet is routed out of the private network, and to replace public addresses with private addresses when a packet is routed from the public network to the private network. The Fibre Channel routing equivalent to this IP-NAT is the Fibre Channel network address translation (FC-NAT). Using FC-NAT, the proxy devices in a fabric can have PIDs that are different from the real devices they represent, allowing the proxy devices to have appropriate PIDs for the address space of their corresponding fabric.

## Inter-switch links

An inter-switch link (ISL) is a link between two switches, E\_Port-to-E\_Port. The ports of the two switches automatically come online as E\_Ports once the login process finishes successfully. For more information on the login process, refer to [Chapter 1, “Understanding Fibre Channel Services”](#).

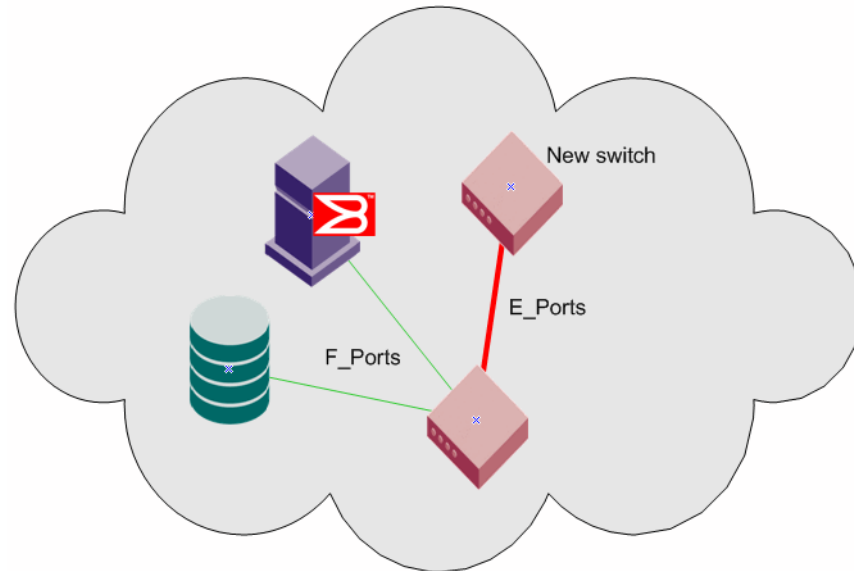

**FIGURE 6** New switch added to existing fabric

You can expand your fabric by connecting new switches to existing switches. [Figure 6](#) shows a new switch being added into an existing fabric. The thick red line is the newly formed ISL.

When connecting two switches together, Brocade recommends the best practice that the following parameters are differentiated:

- Domain ID
- Switch name
- Chassis name

You must also verify the following fabric parameters are identical on each switch for a fabric to merge:

- R\_A\_TOV (Resource Allocation TimeOut Value)
- E\_D\_TOV (Error Detect TimeOut Value)
- Data Field Size
- Sequence Level Switching
- Disable Device Probing
- Suppress Class F Traffic
- Per-frame Route Priority

There are non-fabric parameters that must match as well, such as zoning. Some fabric services, such as management server, must match. If the fabric service is enabled in the fabric, then the switch you are introducing into the fabric must also have it enabled. If you experience a segmented fabric, refer to the *Fabric OS Troubleshooting and Diagnostics Guide* to fix the problem.



## Buffer credits

In order to prevent the dropping of frames in the fabric, a device can never send frames without the receiving device being able to receive them, so an end-to-end flow control is used on the switch. Flow control in Fibre Channel uses buffer-to-buffer credits, which are distributed by the switch. When all buffer-to-buffer credits are utilized, a device waits for a VC\_RDY or an R\_RDY primitive from the destination switch before resuming I/O. The primitive is dependent on whether you have R\_RDYs enabled on your switch using the **portCfgrSLMode** command. When a device logs in to a fabric, it typically requests from two to sixteen buffer credits from the switch, depending on the device type, driver version, and configuration. This determines the maximum number of frames the port can transmit before receiving an acknowledgement from the receiving device.

For more information on how to set the buffer-to-buffer credits on an extended link, refer to [Chapter 23, “Managing Long Distance Fabrics”](#).

## Virtual channels

Virtual channels create multiple logical data paths across a single physical link or connection. They are allocated their own network resources such as queues and buffer-to-buffer credits. Virtual channel technology is the fundamental building block used to construct Adaptive Networking services. For more information on Adaptive Networking services, refer to [Chapter 21, “Optimizing Fabric Behavior”](#).

Virtual channels are divided into three priority groups. P1 is the highest priority, which is used for Class F, F\_RJT, and ACK traffic. P2 is the next highest priority, which is used for data frames. The data virtual channels can be further prioritized to provide higher levels of Quality of Service. P3 is the lowest priority and is used for broadcast and multicast traffic. This example is illustrated in [Figure 7](#).

Quality of Service (QoS) is a licensed traffic shaping feature available in Fabric OS. QoS allows the prioritization of data traffic based on the SID and DID of each frame. Through the use of QoS zones, traffic can be divided into three priorities: high, medium, and low, as shown in [Figure 7](#). The seven data virtual channels, VC8 through VC14, are used to multiplex data frames based upon QoS zones when congestion occurs. For more information on QoS zones, refer to [Chapter 21, “Optimizing Fabric Behavior”](#).

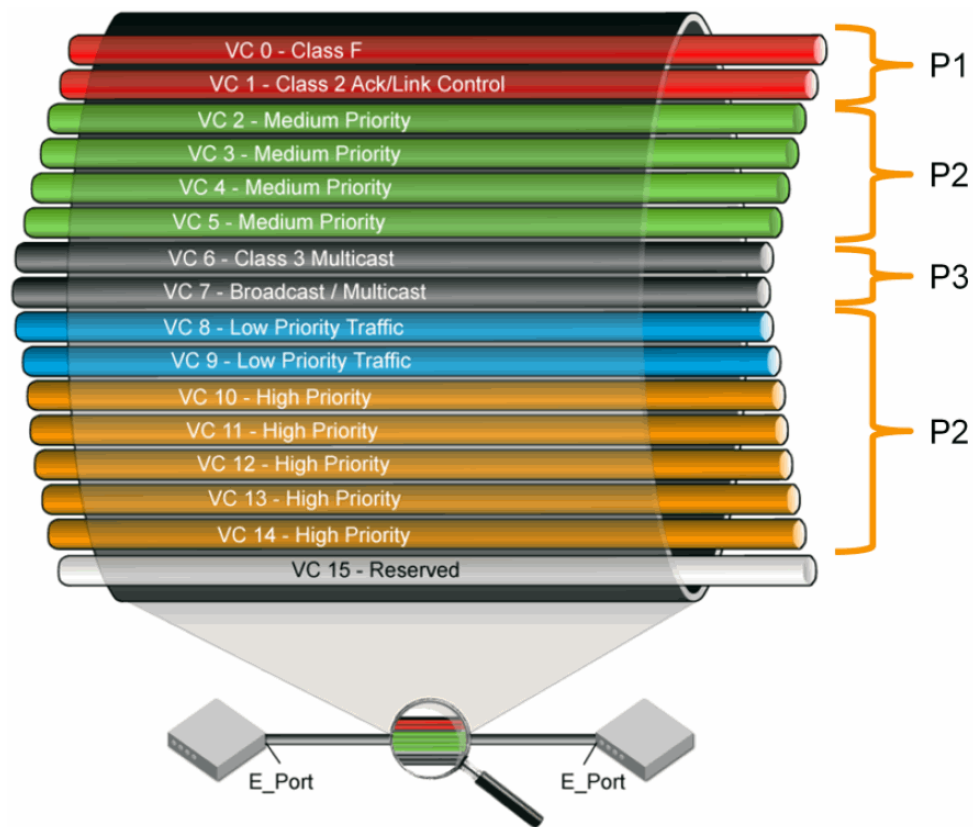
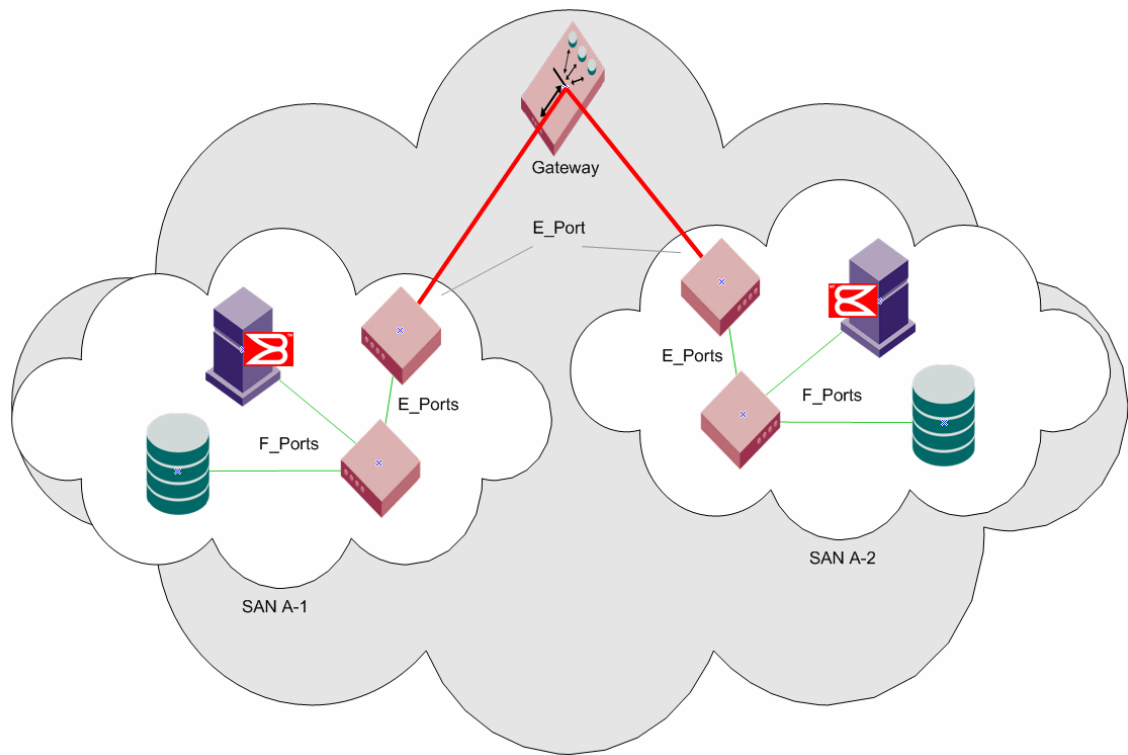

FIGURE 7 Virtual channels on a QoS-enabled ISL

## Gateway links

A gateway merges SANs into a single fabric by establishing point-to-point E\_Port connectivity between two Fibre Channel switches that are separated by a network with a protocol such as IP or SONET.

Except for link initialization, gateways are transparent to switches; the gateway simply provides E\_Port connectivity from one switch to another. [Figure 8](#) shows two separate SANs, A-1 and A-2, merged together using a gateway.



**FIGURE 8** Gateway link merging SANs

By default, switch ports initialize links using the Exchange Link Parameters (ELP) mode 1. However, gateways expect initialization with ELP mode 2, also referred to as ISL R\_RDY mode. Therefore, to enable two switches to link through a gateway, the ports on both switches must be set for ELP mode 2.

Any number of E\_Ports in a fabric can be configured for gateway links, provided the following guidelines are followed:

- All switches in the fabric use the core PID format, as described in [“Configuring a link through a gateway”](#) on page 69.
- The switches connected to both sides of the gateway are included when determining switch-count maximums.
- Extended links (those created using the Extended Fabrics licensed feature) are not supported through gateway links.

## Configuring a link through a gateway

1. Connect to the switch at one end of the gateway and log in using an account assigned to the admin role.
2. Enter the `portCfgIsiMode` command.
3. Repeat steps 1 and 2 for any additional ports that are connected to the gateway.
4. Repeat this procedure on the switch at the other end of the gateway.

### Example of enabling a gateway link on slot 2, port 3

```
ecp:admin> portcfgislmode 2/3, 1
Committing configuration...done.
ISL R_RDY Mode is enabled for port 3. Please make sure the PID
formats are consistent across the entire fabric.
```

## Routing policies

By default, all routing protocols place their routes into a routing table. You can control the routes that a protocol places into each table and the routes from that table that the protocol advertises by defining one or more routing policies and then applying them to the specific routing protocol.

The routing policy is responsible for selecting a route based on one of two user-selected routing policies:

- Port-based routing
- Exchange-based routing

On the Brocade 300, 5100, 5300, 5410, 5450, 5460, 5470, 5480, 6505, 6510, 7800, 8000, and VA-40FC switches, Brocade DCX and DCX 8510 Backbone families, routing is handled by the FSPF protocol and either the port-based routing or exchange-based routing policy.

Each switch can have its own routing policy and different policies can exist in the same fabric.

---

### ATTENTION

For most configurations, the default routing policy is optimal and provides the best performance. You should change the routing policy only if there is a performance issue that is of concern, or if a particular fabric configuration or application requires it.

---

## Displaying the current routing policy

1. Connect to the switch and log in using an account with admin permissions.
2. Enter the **aptPolicy** command with no parameters.

The current policy is displayed, followed by the supported policies for the switch.

### Example of the output from the aptPolicy command

In the following example, the current policy is exchange-based routing (3) with the additional AP dedicated link policy.

```
switch:admin> aptpolicy
Current Policy: 3 1(ap)

3 0(ap): Default Policy
1: Port Based Routing Policy
3: Exchange Based Routing Policy
   0: AP Shared Link Policy
   1: AP Dedicated Link Policy
```

## Exchange-based routing

The choice of routing path is based on the Source ID (SID), Destination ID (DID), and Fibre Channel originator exchange ID (OXID) optimizing path utilization for the best performance. Thus, every exchange can take a different path through the fabric. Exchange-based routing requires the use of the Dynamic Load Sharing (DLS) feature; when this policy is in effect, you cannot disable the DLS feature.

Exchange-based routing is also known as *Dynamic Path Selection* (DPS). DPS is where exchanges or communication between end devices in a fabric are assigned to egress ports in ratios proportional to the potential bandwidth of the ISL or trunk group. When there are multiple paths to a destination, the input traffic is distributed across the different paths in proportion to the bandwidth available on each of the paths. This improves utilization of the available paths, thus reducing possible congestion on the paths. Every time there is a change in the network (which changes the available paths), the input traffic can be redistributed across the available paths. This is a very easy and non-disruptive process when the exchange-based routing policy is engaged.

## Port-based routing

The choice of routing path is based only on the incoming port and the destination domain. To optimize port-based routing, DLS can be enabled to balance the load across the available output ports within a domain.

---

### NOTE

**For FC routers only:** When an FC router is in port-based routing mode, the backbone traffic is load-balanced based on SID and DID. When an FC router is in exchange-based routing mode, the backbone traffic is load-balanced based on SID, DID, and OXID.

---

Whatever routing policy a switch is using applies to the VE\_Ports as well. For more information on VE\_Ports, refer to the *Fibre Channel over IP Administrator's Guide*.

## AP route policy

Two additional AP policies are supported under exchange-based routing:

- AP Shared Link policy (default)
- AP Dedicated Link policy

The AP policies are independent of the routing policies. Every routing policy supports both AP policies.

The AP Dedicated Link policy relieves internal congestion in an environment where:

- There is a large amount of traffic going through both directions at the same time.
- There is a reduction of the effect of slow devices on the overall switch performance.

It is recommended that the default AP Shared Link policy be used for most environments. Also, it is recommended that you design a SAN that localizes host-to-target traffic by reducing the amount of traffic through the router.

---

### ATTENTION

Setting either AP route policy is a disruptive process.

---

### *Routing in Virtual Fabrics*

Virtual Fabrics support DPS on all partitions. DPS is limited where multiple paths are available for a logical fabric frame entering a Virtual Fabrics chassis from a base fabric that is sent out using one of the dedicated ISLs in a logical switch.

The AP policy affecting the DPS behavior, whether it is exchange-based, device-based, or port-based, is configured on a per-logical switch basis. In-order delivery (IOD) and DLS settings are set per logical switch as well. IOD and DLS settings for the base switch affect all traffic going over the base fabric including any logical fabric traffic that uses the base fabric.



#### **CAUTION**

**Setting the routing policy is disruptive to the fabric because it requires that you disable the switch where the routing policy is being changed.**

### *Setting the routing policy*

1. Connect to the VF switch and log in as admin.
2. Enter the **setcontext** command for the correct FID.  

```
switch:admin> setcontext 20
```
3. Enter the **switchDisable** command to disable the switch.
4. Take the appropriate following action based on the AP route policy you choose to implement:
  - If the exchange-based policy is required, enter the **aptPolicy 3** command.
  - If the port-based policy is required, enter the **aptPolicy 1** command.

### *Setting up the AP route policy*

The AP route policy can only be set in the base switches that are using Virtual Fabrics.

1. Connect to the base switch and log in as admin.
2. Enter the **switchDisable** command to disable the switch.
3. Take the appropriate following action based on the AP route policy you choose to implement:
  - If the AP Shared Link policy (default) is required, enter the **aptPolicy -ap 0** command.
  - If the AP Dedicated Link policy is required, enter the **aptPolicy -ap 1** command.

## Route selection

Selection of specific routes can be dynamic, so that the router can constantly adjust to changing network conditions; or it may be static, so that data packets always follow a predetermined path.

## Dynamic Load Sharing

The exchange-based routing policy depends on the Fabric OS Dynamic Load Sharing (DLS) feature for dynamic routing path selection. When using the exchange-based routing policy, DLS is enabled by default and cannot be disabled. In other words, you cannot enable or disable DLS when the exchange-based routing policy is in effect.

When the port-based policy is in force, you can enable DLS to optimize routing. When DLS is enabled, it shares traffic among multiple equivalent paths between switches. DLS recomputes load sharing when any of the following occurs:

- A switch boots up
- An E\_Port goes offline and online
- An EX\_Port goes offline
- A device goes offline

### *Setting DLS*

1. Connect to the switch and log in using an account with admin permissions.
2. Enter the **dlshow** command to view the current DLS setting.

One of the following messages appears:

- "DLS is set" indicates that DLS is turned on.
- "DLS is not set" indicates that DLS is turned off.
- "DLS is set with Lossless enabled." DLS is enabled with the Lossless feature. Load sharing is recomputed with every change in the fabric, and existing routes can be moved to maintain optimal balance. In Lossless mode, no frames are lost during this operation.
- "DLS is set by default with current routing policy. DLS is set with Lossless enabled." The current routing policy (exchange-based) requires DLS to be enabled by default. In addition, the Lossless option is enabled. Frame loss is prevented during a load sharing recomputation. If you get this message, you cannot perform [step 3](#), so you are done with this procedure.

3. Enter the **dlset** command to enable DLS or enter the **dlreset** command to disable it.

#### **Example of setting and resetting DLS**

```
switch:admin> dlshow
DLS is not set
switch:admin> dlset
switch:admin> dlshow
DLS is set
switch:admin> dlreset
switch:admin> dlshow
DLS is not set
```

## Frame order delivery

The order of delivery of frames is maintained within a switch and determined by the routing policy in effect. The frame delivery behaviors for each routing policy are:

- Port-based routing  
All frames received on an incoming port destined for a destination domain are guaranteed to exit the switch in the same order in which they were received.
- Exchange-based routing  
All frames received on an incoming port for a given exchange are guaranteed to exit the switch in the same order in which they were received. Because different paths are chosen for different exchanges, this policy does not maintain the order of frames across exchanges.

If even one switch in the fabric delivers out-of-order exchanges, then exchanges are delivered to the target out of order, regardless of the policy configured on other switches in the fabric.

---

### NOTE

Some devices do not tolerate out-of-order exchanges; in such cases, use the port-based routing policy.

---

In a stable fabric, frames are always delivered in order, even when the traffic between switches is shared among multiple paths. However, when topology changes occur in the fabric (for example, if a link goes down), traffic is rerouted around the failure, and some frames could be delivered out of order. Most destination devices tolerate out-of-order delivery, but some do not.

By default, out-of-order frame-based delivery is allowed to minimize the number of frames dropped. Enabling in-order delivery (IOD) guarantees that frames are either delivered in order or dropped. You should only force in-order frame delivery across topology changes if the fabric contains destination devices that cannot tolerate occasional out-of-order frame delivery.

## Forcing in-order frame delivery across topology changes

1. Connect to the switch and log in using an account with admin permissions.
2. Enter the **iodSet** command.

---

### NOTE

The **iodSet** command can cause a delay in the establishment of a new path when a topology change occurs; use it with care.

---

3. Confirm the in-order delivery has been set by entering the **iodShow** command.

## Restoring out-of-order frame delivery across topology changes

1. Connect to the switch and log in using an account with admin permissions.
2. Enter the **iodReset** command.



## Lossless Dynamic Load Sharing on ports

Lossless Dynamic Load Sharing (DLS) allows you to rebalance port paths without causing input/output (I/O) failures. For devices where in-order delivery (IOD) of frames is required, you can set IOD separately. You can use this feature with the following hardware:

- Brocade 300
- Brocade 5100
- Brocade 5300
- Brocade 6505
- Brocade 6510
- Brocade VA-40FC
- Brocade FC8-16, FC8-32, FC8-48, and FC8-64 port blades
- Brocade DCX 8510 Backbone family and supported blades
- Brocade FC16-32 and FC16-48 port blades
- Brocade FC8-32E and FC8-48E port blades
- Brocade FX8-24 application blades in the Brocade DCX and DCX-4S Backbones

On the Brocade 7800 switch and the FX8-24 application blade, Lossless DLS is supported only on FC-to-FC port flows.

---

### ATTENTION

When you implement Lossless DLS, the switches in the fabric must have either Fabric OS v6.3.0 or Fabric OS v6.4.0 or later installed to guarantee no frame loss.

---

Lossless DLS must be implemented along the path between the target and initiator. You can use Lossless DLS on ports connecting switches to perform the following functions:

- Eliminate dropped frames and I/O failures by rebalancing the paths going over the ISLs whenever there is a fabric event that might result in suboptimal utilization of the ISLs.
- Eliminate the frame delay caused by establishing a new path when a topology change occurs.

Lossless mode means no frame loss during a rebalance and only takes effect if DLS is enabled. Lossless DLS can be enabled on a fabric topology in order to have zero frame drops during rebalance operations. If the end device also requires the order of frames to be maintained during the rebalance operation, then IOD must be enabled. However this combination of Lossless DLS and IOD is supported only in specific topologies, such as in a FICON environment.

You can disable or enable IOD when Lossless DLS is enabled. You can also choose between exchange- or port-based policies with Lossless DLS. Events that cause a rebalance include the following:

- Adding an E\_Port
- Adding a slave E\_Port
- Removing an E\_Port (However, frame loss occurs on traffic flows to this port.)
- Removing an F\_Port (However, frame loss occurs on traffic flows to this port.)

Lossless DLS does the following whenever paths need to be rebalanced:

1. Pauses ingress traffic by not returning credits. Frames that are already in transit are not dropped.
2. Changes the existing path to a more optimal path.
3. If IOD is enabled, waits for sufficient time for frames already received to be transmitted. This is needed to maintain IOD.
4. Resumes traffic.

Table 10 shows the effect of frames when you have a specific routing policy turned on with IOD.

**TABLE 10** Combinations of routing policy and IOD with Lossless DLS enabled

Policy	IOD	Rebalance result with Lossless DLS enabled
Port-based	Disabled	No frame loss, but out-of-order frames may occur.
Port-based	Enabled	No frame loss and no out-of-order frames. Topology restrictions apply. Intended for FICON environment.
Exchange-based	Disabled	No frame loss, but out-of-order frames may occur.
Exchange-based	Enabled	No frame loss and no out-of-order frames. Topology restrictions apply. Intended for FICON environment.

### Lossless core

Lossless core works with the default configuration of the Brocade DCX 8510-8 and DCX 8510-4 hardware to prevent frame loss during a core blade removal and insertion. This feature is on by default and cannot be disabled. Lossless core has the following limitations:

- Only supported with IOD disabled, which means Lossless core cannot guarantee in-order delivery of exchanges
- ICL limitations
- Traffic flow limitations

#### *ICL limitations*

If ICL ports are connected during a core blade removal, it is equivalent to removing external E\_Ports which may cause I/O disruption on the ICL ports that have been removed.

If ICL ports are connected during a core blade insertion, it is equivalent to adding external E\_Ports which may cause I/O disruption due to reroutes. Lossless DLS, if enabled, takes effect to prevent I/O disruption.

#### *Traffic flow limitations*

The FA4-18 and FR4-18i AP blades, which are supported on the Brocade DCX and DCX-4S, may continue to experience frame drops after core blade removal or insertion. The path between an FC10-6, FA4-18, or FR4-18i blade and an FX8-24 blade, or vice versa, experiences I/O disruption because the FC10-6, FA4-18, and FR4-18i blades do not support this feature.

## Configuring Lossless Dynamic Load Sharing

You configure Lossless DLS switch- or chassis-wide by using the **dlsSet** command to specify that no frames are dropped while rebalancing or rerouting traffic.

1. Connect to the switch and log in using an account with admin permissions.
2. Enter the appropriate **dlsSet** command to enable or disable Lossless Dynamic Load Sharing.

```
switch:admin>dlsset --enable -lossLess  
switch:admin>dlsset --disable -lossLess
```

## Lossless Dynamic Load Sharing in Virtual Fabrics

Enabling Lossless Dynamic Load Sharing is optional on logical switches in Virtual Fabrics. If you enable this feature, it must be on a per-logical switch basis and can affect other logical switches in the fabric. XISL use must be disabled for Lossless DLS to be enabled.

### *How DLS affects other logical switches in the fabric*

On a Brocade DCX platform, logical switch 1 consists of ports 0 through 5 in slot 1. Logical switch 2 consists of ports 6 through 10 in slot 1. The Lossless DLS feature is enabled on logical switch 1. Because ports 0 through 10 in slot 1 belong to a logical switch where Lossless DLS is enabled, the traffic in logical switch 2 is affected whenever traffic for logical switch 1 is rebalanced.

---

#### ATTENTION

Although Lossless DSL is enabled for a specific logical switch, you must have chassis-level permissions to use this feature.

---

This effect on logical switch 2 is based on the configuration on logical switch 2:

- If logical switch 2 has IOD enabled (**iodSet** only), IOD is enforced.
- If logical switch 2 has Lossless DLS enabled, traffic is paused and resumed.
- If logical switch 2 has no IOD (**iodReset**), traffic is paused and resumed.

To avoid this behavior, it is recommended to define your logical switches as follows:

- Define logical switches that require Lossless DLS at the blade boundary.
- Define logical switches that require Lossless DLS only using supported blades. For example, do not use blades that support IOD, but do not support Lossless DLS.

For more information on Virtual Fabrics and chassis-level permissions, refer to [Chapter 10, "Managing Virtual Fabrics"](#).

## Enabling forward error correction

Forward error correction (FEC) provides method error control during data transmission by sending redundant data to ensure error-free transmission on a specified port or port range.

---

#### NOTE

FEC is configurable only on 16 Gbps-capable switches (Brocade 6505, 6510, and Brocade DCX 8510 Backbone family).

---

FEC is useful when broadcasting data to many destinations simultaneously from a single source, when retransmissions might be costly.

Use the **portCfgFec** command to enable and disable FEC on a port, as shown in the following examples.

1. Connect to the switch and log in using an account with admin permissions.
2. Enter the **portcfgfec** command, specifying the port or range of ports on which FEC is to be enabled.

```
portcfgfec --enable slot/port
```

To enable the FEC feature on a single port and display the configuration, enter the following commands.

```
switch:admin> portcfgfec --enable 1
switch:admin> portcfgfec --show 1
Forward Error Correction capable: ON
Forward Error Correction configured: ON
```

To enable the FEC feature on a port range, enter the following command. In this example, port 1 already has FEC enabled, and so it remains enabled.

```
switch:admin> portcfgfec --enable 0-8
Same configuration for port 1
```

To disable the FEC feature on a port range, enter the following command.

```
switch:admin> portcfgfec --disable 0-8
```

## Frame Redirection

Frame Redirection provides a means to redirect traffic flow between a host and a target that use virtualization and encryption applications, such as the Brocade SAS blade and Brocade Data Migration Manager (DMM), so that those applications can perform without having to reconfigure the host and target. You can use this feature if the hosts and targets are not directly attached.

Frame Redirection depends on the wide distribution of the Defined Zone Database. The Defined Zone Database on Fabric OS switches is pushed out to all other Fabric OS switches in the fabric that support Frame Redirection. Redirection zones exist only in the defined configuration and cannot be added to the effective configuration.

---

### NOTE

Fabric OS v7.0.1 is not supported on the Brocade 7600 or Brocade SAS blade. However, this hardware can run in a pre-Fabric OS v7.0.1 system and attach to a Fabric OS v7.0.1 fabric.

---

Frame Redirection uses a combination of special frame redirection zones and name server changes to spoof the mapping of real device WWNs to virtual PIDs.



### Viewing redirect zones

1. Connect to the switch and log in using an account with admin permissions.
2. Enter the **cfgShow** command.

# Managing User Accounts

---

## In this chapter

- [User accounts overview](#) ..... 81
- [Local database user accounts](#) ..... 85
- [Local account database distribution](#) ..... 88
- [Password policies](#) ..... 89
- [The boot PROM password](#) ..... 93
- [The authentication model using RADIUS and LDAP](#) ..... 97

## User accounts overview

In addition to the default permissions assigned to the following roles: root, factory, admin, and user, Fabric OS supports up to 252 additional user accounts on the chassis. These accounts expand your ability to track account access and audit administrative activities.

Each user account is associated with the following:

- Admin Domain list – Specifies the Administrative Domains a user account is allowed to log in to.
- Home Admin Domain – Specifies the Admin Domain that the user is logged in to by default. The home Admin Domain must be a member of the user’s Admin Domain list.
- Permissions – Associate roles with each user account to determine the functional access levels within the bounds of the your current Admin Domain.
- Virtual Fabric list – Specifies the Virtual Fabric a user account is allowed to log in to.
- Home Virtual Fabric – Specifies the Virtual Fabric that the user is logged in to, if available. The home Virtual Fabric must be a member of the user’s Virtual Fabric list. If the fabric ID is not available, the next lower valid fabric ID is used.
- LF Permission List – Determines functional access levels within the bounds of the user’s Virtual Fabrics.
- Chassis role – Similar to switch-level roles, but applies to a different subset of commands.

---

### NOTE

Admin Domains are mutually exclusive from Virtual Fabrics permissions when setting up user accounts. You will need to set up different user accounts for each feature.

You cannot have Admin Domain mode and Virtual Fabrics mode enabled at the same time.

---

For more information about Admin Domains, refer to [Chapter 17, “Managing Administrative Domains”](#).

For more information about Virtual Fabrics, refer to [Chapter 10, “Managing Virtual Fabrics”](#).

Fabric OS provides three options for authenticating users—remote RADIUS services, remote LDAP service, and the local switch user database. All options allow users to be centrally managed using the following methods:

- **Remote RADIUS server:** Users are managed in a remote RADIUS server. All switches in the fabric can be configured to authenticate against the centralized remote database.
- **Remote LDAP server:** Users are managed in a remote LDAP server. All switches in the fabric can be configured to authenticate against the centralized remote database.
- **Local user database:** Users are managed using the local user database. The local user database is manually synchronized using the **distribute** command to push a copy of the switch’s local user database to all other Fabric OS v5.3.0 and later switches in the fabric, but the **distribute** command is blocked if users with user-defined roles exist on the sending switch or on any remote, receiving switch.

## Role-Based Access Control

Role-Based Action Control (RBAC) specifies the permissions that a user account has based on the role the account has been assigned. For each role, there is a set of predefined permissions on the jobs and tasks that can be performed on a fabric and its associated fabric elements. Fabric OS uses RBAC to determine which commands a user has access to.

When you log in to a switch, your user account is associated with a predefined role or a user-defined role. The role that your account is associated with determines the level of access you have on that switch and in the fabric. The chassis role can also be associated with user defined roles; it has permissions for RBAC classes of commands which are configured during user-defined role creation. The chassis role is similar to a switch-level role except that it affects a different subset of commands. You can use the **userConfig** command to add this permission to a user account.

Table 11 outlines the Fabric OS predefined roles.

**TABLE 11** Default Fabric OS roles

Role name	Duties	Description
Admin	All administration	All administrative commands.
BasicSwitchAdmin	Restricted switch administration	Mostly monitoring with limited switch (local) commands.
FabricAdmin	Fabric and switch administration	All switch and fabric commands, excludes user management and Admin Domains commands.
Operator	General switch administration	Routine switch maintenance commands.
SecurityAdmin	Security administration	All switch security and user management functions.
SwitchAdmin	Local switch administration	Most switch (local) commands, excludes security, user management, and zoning commands.
User	Monitoring only	Nonadministrative use, such as monitoring system activity.
ZoneAdmin	Zone administration	Zone management commands only.

**Admin Domain considerations:** Legacy users with no Admin Domain specified and their current role is admin will have access to AD 0 through 255 (physical fabric admin); otherwise, they will have access to ADO only.



If some Admin Domains have been defined for the user and all of them are inactive, the user will not be allowed to log in to any switch in the fabric. If no Home Domain is specified for a user, the system provides a default home domain.

The default home domain for the predefined account is ADO. For user-defined accounts, the default home domain is the Admin Domain in the user's Admin Domain list with the lowest ID.

## Role permissions

Table 12 describes the types of permissions that are assigned to roles.

**TABLE 12** Permission types

Abbreviation	Definition	Description
O	Observe	The user can run commands using options that display information only, such as running <code>userConfig --show -a</code> to show all users on a switch.
M	Modify	The user can run commands using options that create, change, and delete objects on the system, such as running <code>userConfig --change username -r rolename</code> to change a user's role.
OM	Observe and Modify	The user can run commands using both observe and modify options; if a role has modify permissions, it almost always has observe.
N	None	The user is not allowed to run commands in a given category.

To view the permission type for categories of commands, use the `classConfig` command:

1. Enter the `classConfig --show -classlist` command to list all command categories.
2. Enter the `classConfig --showroles` command with the command category of interest as the argument.

This command shows the permissions that apply to all commands in a specific category. For example:

```
classconfig --showroles authentication
Roles that have access to the RBAC Class 'authentication' are:
```

```

Role name          Permission
-----
Admin              OM
Factory            OM
Root               OM
Security Admin     OM
```

You can also use the `classConfig --showcli` command to show the permissions that apply to a specific command.

## The management channel

The management channel is the communication established between the management workstation and the switch. Table 13 shows the number of simultaneous login sessions allowed for each role when authenticated locally. The roles are displayed in alphabetic order which does not reflect their importance. When authenticating using LDAP or RADIUS, the total number of sessions on a switch may not exceed 32.

**TABLE 13** Maximum number of simultaneous sessions

Role name	Maximum sessions
Admin	2
BasicSwitchAdmin	4
FabricAdmin	4
Operator	4
SecurityAdmin	4
SwitchAdmin	4
User	4
ZoneAdmin	4

## Managing user-defined roles

Fabric OS provides an extensive toolset for managing user defined roles:

- The **roleConfig** command is available for defining new roles, deleting created roles, or viewing information about user-defined roles.
- The **classConfig** command is available for displaying RBAC information about each category or class of commands, including an option to show all roles associated with a given RBAC command category.
- The **userConfig** command can be used to assign a user-defined role to a user account.

### *Creating a user-defined role*

You can define a role as long as it has a unique name that is not the same as any of the Fabric OS default roles, any other user-defined role, or any existing user account name.

The following conditions also apply:

- A role name is case-insensitive and contains only letters.
- The role name should have a minimum of 4 letters and can be up to 16 letters long.
- The maximum number of user-defined roles that are allowed on a chassis is 256.

The **roleConfig** command can be used to define unique roles. You must have chassis level access and permissions to execute this command. The following example creates a user-defined role called mysecurityrole. The RBAC class Security is added to the role, and the Observe permission is assigned:

```
> roleconfig --add mysecurityrole -class security -perm O
Role added successfully
```

The assigned permissions can be no higher than the Admin role permission assigned to the class. The Admin role permission for the Security class is Observe/Modify. Therefore, the Observe permission is valid.

The **roleConfig --show** command is available to view the permissions assigned to a user-defined role. You can also use the **classConfig --showroles** command to see that the role was indeed added with Observe permission for the security commands:

```
> classConfig --showroles security
Roles that have access to RBAC Class 'security' are:
```

Role Name	Permissions
-----	-----
User	O
Admin	OM
Factory	OM
Root	OM
SwitchAdmin	O
FabricAdmin	OM
BasicSwitchAdmin	O
SecurityAdmin	OM
mysecurityrole	O

To delete a user-defined role, use the `roleConfig --delete` command.

### *Assigning a user-defined role to a user*

You can assign a user-defined role to a user using one of the following options of the `userConfig` command:

- `userConfig --add` with the `-r` option to create a new user account and assign a role.
- `userConfig --change` with the `-r` option to add or change a user-defined role for an existing user account.
- `userConfig --add` with the `-c` option to create a new user account and assign a chassis role.
- `userConfig --change` with the `-c` options to add a chassis role to an account.

The following example assigns the `mysecurityrole` role to the existing `anewuser` account and adds the admin chassis role:

```
> userConfig --change anewuser -r mysecurityrole -c admin
```

## Local database user accounts

User **add**, **change**, and **delete** operations are subject to the *subset* rule: an admin with ADlist 0-10 or LFlist 1-10 cannot perform operations on an *admin*, *user*, or *any* role with an ADlist 11-25 or LFlist 11-128. The user account being changed must have an ADlist or LFlist that is a subset of the account that is making the change.

In addition to the default administrative and user accounts, Fabric OS supports up to 252 user-defined accounts in each switch (domain). These accounts expand your ability to track account access and audit administrative activities.

### Default accounts

[Table 14](#) lists the predefined accounts offered by Fabric OS available in the local switch user database. The password for all default accounts should be changed during the initial installation and configuration for each switch.

TABLE 14 Default local user accounts

Account name	Role	Admin Domain	Logical Fabric	Description
admin	Admin	ADO-255 home: 0	LF1-128 home: 128	Most commands have <i>observe-modify</i> permission.
factory	Factory	ADO-255 home: 0	LF1-128 home: 128	Reserved.
root	Root	ADO-255 home: 0	LF1-128 home: 128	Reserved.
user	User	ADO home: 0	LF-128 home: 128	Most commands have <i>observe-only</i> permission.

**Admin Domain and Virtual Fabrics considerations:** Administrators can act on other accounts only if that account has an Admin Domain or Logical Fabric list that is a subset of the administrator.

### *Displaying account information*

1. Connect to the switch and log in using an account with admin permissions, or an account associated with a user-defined role with permissions for the UserManagement class of commands.
2. Enter the appropriate **show** operands for the account information you want to display:
  - **userConfig --show -a** to show all account information for a switch
  - **userConfig --show username** to show account information for the specified account
  - **userConfig --showad -a adminDomain\_ID** to show all accounts permitted to select the specified adminDomain\_ID
  - **userConfig --showlf -l logicalFabric\_ID** for each LF in an LF\_ID\_list, displays a list of users that include that LF in their LF permissions.

### *Creating an account*

1. Connect to the switch and log in using an account with admin permissions, or an account associated with a user-defined role with permissions for the UserManagement class of commands.
2. Enter the **userConfig --add** command. For example:

```
> userconfig --add metoo -l 1-128 -h 128 -r admin -c admin
```

This example creates a user account for the user metoo with the following properties:

- Access to Virtual Fabrics 1 through 128
  - Default home logical switch to 128
  - Admin role permissions
  - Admin chassis role permissions
3. In response to the prompt, enter a password for the account.  
The password is not displayed when you enter it on the command line.

### *Deleting an account*

This procedure can be performed on local user accounts.

1. Connect to the switch and log in using an account with admin permissions, or an account associated with a user-defined role with permissions for the UserManagement class of commands.
2. Enter the **userConfig --delete** command.

---

**NOTE**

You cannot delete the default accounts. An account cannot delete itself. All active CLI sessions for the deleted account are logged out.

---

3. At the prompt for confirmation, enter **y**.

### *Changing account parameters*

This procedure can be performed on local user accounts.

When changing account parameters, if you change the ADlist for the user account, all of the currently active sessions for that account will be logged out. For more information about changing the Admin Domain on an account, refer to [Chapter 17, “Managing Administrative Domains”](#).

1. Connect to the switch and log in using an account with admin permissions.
2. Enter the **userConfig --change** command.

## Local account passwords

The following rules apply to changing passwords:

- Users can change their own passwords.
- To change the password for another account requires Admin permissions or an account associated with a user-defined role with Modify permissions for the LocalUserEnvironment RBAC class of commands. When changing an Admin account password, you must provide the current password.
- An admin with ADlist 0-10 or LFlist 1-10 cannot change the password on an *admin*, *user*, or *any* permission with an ADlist 11-25 or LFlist 11-128. The user account being changed must have an ADlist that is a subset of the account that is making the change.
- A new password must have at least one character different from the previous password.
- You cannot change passwords using SNMP.

### *Changing the password for the current login account*

1. Connect to the switch and log in using an account with admin permissions.
2. Enter the **passwd** command.
3. Enter the requested information at the prompts.

### *Changing the password for a different account*

1. Connect to the switch and log in using an account with admin permissions.
2. Enter the **passwd** command specifying the name of the account for which the password is being changed.
3. Enter the requested information at the prompts.

## Local account database distribution

Fabric OS allows you to distribute the user database and passwords to other switches in the fabric. When the switch accepts a distributed user database, it replaces the local user database with the user database it receives.

By default, switches accept the user databases and passwords distributed from other switches. The 'Locked' status of a user account is not distributed as part of local user database distribution.

When distributing the user database, the database may be rejected by a switch for one of the following reasons:

- One of the target switches does not support local account database distribution.
- One of the target switch's user database is protected.
- One of the remote switches has logical switches defined.
- Either the local switch or one of the remote switches has user accounts associated with user-defined roles.

### Distributing the local user database

When distributing the local user database, all user-defined accounts residing in the receiving switches are logged out of any active sessions.

1. Connect to the switch and log in using an account with admin permissions.
2. Enter the **distribute -p PWD -d** command.

---

#### NOTE

If Virtual Fabrics mode is enabled and there are logical switches defined other than the default logical switch, then distributing the password database to switches is not supported.

If the **distribute** command is issued from a pre-Fabric OS v6.2.0, switches running Fabric OS v6.2.0 or later will reject it.

Distributing the password database to switches is not allowed if there are users associated with user defined roles in either the sending switch or remote switch

---

### Accepting distributed user databases on the local switch

1. Connect to the switch and log in using an account with admin permissions.
2. Enter the **fddCfg --localaccept PWD** command.

## Rejecting distributed user databases on the local switch

1. Connect to the switch and log in using an account with admin permissions.
2. Enter the `fddCfg --localreject PWD` command.

## Password policies

The password policies described in this section apply to the local switch user database only. Configured password policies (and all user account attribute and password state information) are synchronized across CPs and remain unchanged after an HA failover. Password policies can also be manually distributed across the fabric (see [“Local account database distribution”](#) on page 88). Following is a list of the configurable password policies:

- Password strength
- Password history
- Password expiration
- Account lockout

All password policies are enforced during logins to the standby CP. However, you may observe that the password enforcement behavior on the standby CP is inconsistent with prior login activity because password state information from the active CP is automatically synchronized with the standby CP, thereby overwriting any password state information that was previously stored there. Also, password changes are not permitted on the standby CP.

Password authentication policies configured using the `passwdCfg` command are *not* enforced during initial prompts to change default passwords.

### Password strength policy

The password strength policy is enforced across all user accounts, and enforces a set of format rules to which new passwords must adhere. The password strength policy is enforced only when a new password is defined. The total of the other password strength policy parameters (lowercase, uppercase, digits, and punctuation) must be less than or equal to the value of the `MinLength` parameter.

Use the following attributes to set the password strength policy:

- **Lowercase**  
Specifies the minimum number of lowercase alphabetic characters that must appear in the password. The default value is zero. The maximum value must be less than or equal to the `MinLength` value.
- **Uppercase**  
Specifies the minimum number of uppercase alphabetic characters that must appear in the password. The default value is zero. The maximum value must be less than or equal to the `MinLength` value.
- **Digits**  
Specifies the minimum number of numeric digits that must appear in the password. The default value is zero. The maximum value must be less than or equal to the `MinLength` value.

- **Punctuation**

Specifies the minimum number of punctuation characters that must appear in the password. All printable, non-alphanumeric punctuation characters except the colon ( : ) are allowed. The default value is zero. The maximum value must be less than or equal to the MinLength value.
- **MinLength**

Specifies the minimum length of the password. The minimum can be from 8 to 40 characters. New passwords must be between the minimum length specified and 40 characters. The default value is 8. The maximum value must be greater than or equal to the MinLength value.
- **Repeat**

Specifies the length of repeated character sequences that will be disallowed. For example, if the “repeat” value is set to 3, a password “passAAAword” is disallowed because it contains the repeated sequence “AAA”. A password of “passAAword” would be allowed because no repeated character sequence exceeds two characters. The range of allowed values is 1 – 40. The default value is 1.
- **Sequence**

Specifies the length of sequential character sequences that will be disallowed. A sequential character sequence is defined as a character sequence in which the ASCII value of each contiguous character differs by one. The ASCII value for the characters in the sequence must all be increasing or decreasing. For example, if the “sequence” value is set to 3, a password “passABCword” is disallowed because it contains the sequence “ABC”. A password of “passABword” would be allowed because it contains no sequential character sequence exceeding two characters. The range of allowed values is 1 – 40. The default value is 1. When set to 1, sequential characters are not enforced.

### Example of a password strength policy

The following example shows a password strength policy that requires passwords to contain at least 3 uppercase characters, 4 lowercase characters and 2 numeric digits; the minimum length of the password is 9 characters.

```
passwdcfg --set -uppercase 3 -lowercase 4 -digits 2 -minlength 9
```

## Password history policy

The password history policy prevents users from recycling recently used passwords, and is enforced across all user accounts when users are setting their own passwords. The password history policy is enforced only when a new password is defined.

Specify the number of past password values that are disallowed when setting a new password. Allowable password history values range between 0 and 24. If the value is set to 0, it means that the new password cannot be set to current password, but can be set to the most recent password. The default value is 1, which means the current and one previous password cannot be reused. The value 2 indicates that the current and the two previous passwords cannot be used (and so on, up to 24 passwords).

This policy does not verify that a new password meets a minimal standard of difference from prior passwords, rather, it only determines whether or not a newly-specified password is identical to one of the specified number (1-24) of previously used passwords.

The password history policy is not enforced when an administrator sets a password for another user; instead, the user’s password history is preserved and the password set by the administrator is recorded in the user’s password history.



## Password expiration policy

The password expiration policy forces expiration of a password after a configurable period of time, and is enforced across all user accounts. A warning that password expiration is approaching is displayed when the user logs in. When a user's password expires, he or she must change the password to complete the authentication process and open a user session. You can specify the number of days prior to password expiration during which warnings will commence. Password expiration does not disable or lock out the account.

Use the following attributes to set the password expiration policy:

- **MinPasswordAge**

Specifies the minimum number of days that must elapse before a user can change a password. **MinPasswordAge** values range from 0 to 999. The default value is zero. Setting this parameter to a non-zero value discourages users from rapidly changing a password in order to circumvent the password history setting to select a recently-used password. The **MinPasswordAge** policy is not enforced when an administrator changes the password for another user.

- **MaxPasswordAge**

Specifies the maximum number of days that can elapse before a password must be changed, and is also known as the password expiration period. **MaxPasswordAge** values range from 0 to 999. The default value is zero. Setting this parameter to zero disables password expiration.

- **Warning**

Specifies the number of days prior to password expiration that a warning about password expiration is displayed. **Warning** values range from 0 to 999. The default value is 0 days.

---

**NOTE**

When **MaxPasswordAge** is set to a non-zero value, **MinPasswordAge** and **Warning** must be set to a value that is less than or equal to **MaxPasswordAge**.

---

## Account lockout policy

The account lockout policy disables a user account when that user exceeds a specified number of failed login attempts, and is enforced across all user accounts. You can configure this policy to keep the account locked until explicit administrative action is taken to unlock it, or the locked account can be automatically unlocked after a specified period. Administrators can unlock a locked account at any time.

A failed login attempt counter is maintained for each user on each switch instance. The counters for all user accounts are reset to zero when the account lockout policy is enabled. The counter for an individual account is reset to zero when the account is unlocked after a lockout duration period expires, or when the account user logs in successfully.

The admin account can also have the lockout policy enabled on it. The admin account lockout policy is disabled by default and uses the same lockout threshold as the other permissions. It can be automatically unlocked after the lockout duration passes or when it is manually unlocked by either a user account that has a **securityAdmin** or other **Admin** permissions.

**Virtual Fabrics considerations:** The home logical fabric context is used to validate user enforcement for the account lockout policy.

The following commands are used to manage the account lockout policy.

- `userConfig --change account_name -u`
- `passwdCfg --disableadminlockout`

Note that the account-locked state is distinct from the account-disabled state.

Use the following attributes to set the account lockout policy:

- **LockoutThreshold**  
Specifies the number of times a user can attempt to log in using an incorrect password before the account is locked. The number of failed login attempts is counted from the last successful login. LockoutThreshold values range from 0 to 999, and the default value is 0. Setting the value to 0 disables the lockout mechanism.
- **LockoutDuration**  
Specifies the time, in minutes, after which a previously locked account is automatically unlocked. LockoutDuration values range from 0 to 99999, and the default value is 30. Setting the value to 0 disables lockout duration, and would require a user to seek administrative action to unlock the account. The lockout duration begins with the first login attempt after the LockoutThreshold has been reached. Subsequent failed login attempts do not extend the lockout period.

### *Enabling the admin lockout policy*

1. Log in to the switch using an account that is an Admin securityAdmin permissions.
2. Enter the `passwdCfg --enableadminlockout` command.

### *Unlocking an account*

1. Log in to the switch using an account that has Admin securityAdmin permissions.
2. Enter the `userConfig --change account_name -u` command specifying the name of the user account that is locked out.

### *Disabling the admin lockout policy*

1. Log in to the switch using an account that has Admin or securityAdmin permissions.
2. Enter the `passwdCfg --disableadminlockout` command.

### *Denial of service implications*

The account lockout mechanism may be used to create a denial of service condition by repeatedly attempting to log in to an account using an incorrect password. Selected privileged accounts are exempted from the account lockout policy to prevent them from being locked out from a denial of service attack. However these privileged accounts may then become the target of password guessing attacks. Audit logs should be examined to monitor if such attacks are attempted.

## The boot PROM password

The boot PROM password provides an additional layer of security by protecting the boot PROM from unauthorized use. Setting a recovery string for the boot PROM password enables you to recover a lost boot PROM password by contacting your switch service provider. Without the recovery string, a lost boot PROM password cannot be recovered.

Although you can set the boot PROM password without also setting the recovery string, it is strongly recommended that you set both the password and the recovery string. If your site procedures dictate that you set the boot PROM password without the recovery string, see [“Setting the boot PROM password for a switch without a recovery string”](#) on page 95.

To set the boot PROM password with or without a recovery string, refer to the section that applies to your switch or Backbone model.



### CAUTION

Setting the boot PROM password requires accessing the boot prompt, which stops traffic flow through the switch until the switch is rebooted. Perform this procedure during a planned downtime.

## Setting the boot PROM password for a switch with a recovery string

This procedure applies to the following switch models: Brocade 300, 5410, 5424, 5450, 5460, 5470, 5480, 5100, 5300, 65,10, 7800, 8000, and 8510 switches. If your switch is not listed, please contact your switch support provider for instructions.

1. Connect to the serial port interface as described in [“Connecting to Fabric OS through the serial port”](#) on page 16.
2. Reboot the switch.
3. Press **ESC** within four seconds after the message “Press escape within 4 seconds...” displays.

The following options are available:

Option	Description
1 Start system.	Continues the system boot process.
2 Recovery password.	Lets you set the recovery string and the boot PROM password.
3 Enter command shell.	Provides access to boot parameters.

4. Enter **2**.

- If no password was previously set, the following message displays:

```
Recovery password is NOT set. Please set it now.
```

- If a password was previously set, the following messages display:

```
Send the following string to Customer Support for password recovery:
afHTpyLsDolPz0Pk5GzhIw==
Enter the supplied recovery password.
Recovery Password:
```

5. Enter the recovery password (string).

The recovery string must be between 8 and 40 alphanumeric characters. A random string that is 15 characters or longer is recommended for higher security. The firmware prompts for this password only once. It is not necessary to remember the recovery string because it is displayed the next time you enter the command shell.

The following prompt displays:

```
New password:
```

6. Enter the boot PROM password, then re-enter it when prompted. The password must be eight alphanumeric characters (any additional characters are not recorded). Record this password for future use.

The new password is automatically saved.

7. Reboot the switch by typing the **reset** command at the prompt.

### Setting the boot PROM password for a Backbone with a recovery string

This procedure applies to the Brocade DCX and DCX-4S Backbones.

The boot PROM and recovery passwords must be set for each CP blade on Brocade DCX and DCX-4S Backbones.

1. Connect to the serial port interface on the standby CP blade, as described in [“Connecting to Fabric OS through the serial port”](#) on page 16.
2. Connect to the active CP blade by serial or Telnet and enter the **haDisable** command to prevent failover during the remaining steps.
3. Reboot the standby CP blade by sliding the On/Off switch on the ejector handle of the standby CP blade to Off, and then back to On.
4. Press **ESC** within four seconds after the message “Press escape within 4 seconds...” displays.

The following options are available:

Option	Description
1 Start system.	Continues the system boot process.
2 Recovery password.	Lets you set the recovery string and the boot PROM password.
3 Enter command shell.	Provides access to boot parameters.

5. Enter **2**. Take the following appropriate action based on whether you find the password was previously set:

- If no password was previously set, the following message displays:

```
Recovery password is NOT set. Please set it now.
```

- If a password was previously set, the following messages display:

```
Send the following string to Customer Support for password recovery:  
afHTpyLsDo1Pz0Pk5GzhIw==  
Enter the supplied recovery password.  
Recovery Password:
```

6. Enter the recovery password (string).

The recovery string must be between 8 and 40 alphanumeric characters. A random string that is 15 characters or longer is recommended for higher security. The firmware only prompts for this password once. It is not necessary to remember the recovery string because it is displayed the next time you enter the command shell.

The following prompt displays:

```
New password:
```

7. Enter the boot PROM password, then re-enter it when prompted. The password must be eight alphanumeric characters (any additional characters are not recorded). Record this password for future use.

The new password is automatically saved (the **saveEnv** command is not required).

8. Connect to the active CP blade using serial or Telnet and enter the **haEnable** command to restore high availability; then fail over the active CP blade by entering the **haFailover** command.

Traffic flow through the active CP blade resumes when the failover is complete.

9. Connect the serial cable to the serial port on the new standby CP blade (previously the active CP blade).
10. Repeat [step 2](#) through [step 7](#) for the new standby CP blade (each CP blade has a separate boot PROM password).
11. Connect to the active CP blade by serial or Telnet and enter the **haEnable** command to restore high availability.

Although you can set the boot PROM password without also setting the recovery string, it is strongly recommended that you set both the password and the string as described in [“Setting the boot PROM password for a switch with a recovery string”](#) on page 93. If your site procedures dictate that you must set the boot PROM password without the string, follow the procedure that applies to your switch model.

## Setting the boot PROM password for a switch without a recovery string

This procedure applies to the fixed-port switch models.

The password recovery instructions contained within this section are only for the switches listed. If your switch is not listed, contact your switch support provider for instructions.

1. Create a serial connection to the switch as described in [“Connecting to Fabric OS through the serial port”](#) on page 16.
2. Reboot the switch by entering the **reboot** command.
3. Press **ESC** within four seconds after the message “Press escape within 4 seconds...” displays.

The following options are available:

Option	Description	
1	Start system.	Continues the system boot process.
2	Recovery password.	Lets you set the recovery string and the boot PROM password.
3	Enter command shell.	Provides access to boot parameters.

4. Enter **3**.

5. At the shell prompt, enter the **passwd** command.

---

**NOTE**

The **passwd** command only applies to the boot PROM password when it is entered from the boot interface.

---

6. Enter the boot PROM password at the prompt, then re-enter it when prompted. The password must be eight alphanumeric characters (any additional characters are not recorded). Record this password for future use.
7. Enter the **saveEnv** command to save the new password.
8. Reboot the switch by entering the **reset** command.

### Setting the boot PROM password for a Backbone without a recovery string

This procedure applies to the Brocade DCX and DCX-4S Backbones.

On the Brocade DCX Backbone, set the password on the standby CP blade, fail over, and then set the password on the previously active (now standby) CP blade to minimize disruption to the fabric.

1. Determine the active CP blade by opening a Telnet session to either CP blade, connecting as admin, and entering the **haShow** command.
2. Connect to the active CP blade by serial or Telnet and enter the **haDisable** command to prevent failover during the remaining steps.
3. Create a serial connection to the standby CP blade as described in [“Connecting to Fabric OS through the serial port”](#) on page 16.
4. Reboot the standby CP blade by sliding the On/Off switch on the ejector handle of the standby CP blade to Off, and then back to On.

This causes the blade to reset.

5. Press **ESC** within four seconds after the message `Press escape within 4 seconds...` displays.

The following options are available:

Option	Description
1 Start system.	Continues the system boot process.
2 Recovery password.	Lets you set the recovery string and the boot PROM password.
3 Enter command shell.	Provides access to boot parameters.

6. Enter **3**.
7. Enter the **passwd** command at the shell prompt.

---

**NOTE**

The **passwd** command applies only to the boot PROM password when it is entered from the boot interface.

---

8. Enter the boot PROM password at the prompt, then re-enter it when prompted. The password must be eight alphanumeric characters (any additional characters are not recorded). Record this password for future use.

9. Enter the **saveEnv** command to save the new password.
10. Reboot the standby CP blade by entering the **reset** command.
11. Connect to the active CP blade by serial or Telnet and enter the **haEnable** command to restore high availability; then fail over the active CP blade by entering the **haFailover** command.  
Traffic resumes flowing through the newly active CP blade after it has completed rebooting.
12. Connect the serial cable to the serial port on the new standby CP blade (previously the active CP blade).
13. Repeat [step 3](#) through [step 10](#) for the new standby CP blade.
14. Connect to the active CP blade by serial or Telnet and enter the **haEnable** command to restore high availability.

---

**NOTE**

To recover lost passwords refer to the *Fabric OS Troubleshooting and Diagnostics Guide*.

---

## The authentication model using RADIUS and LDAP

Fabric OS supports the use of either the local user database and the remote authentication dial-in user service (RADIUS) at the same time; or the local user database and lightweight directory access protocol (LDAP) using Microsoft Active Directory in Windows at the same time. A switch can be configured to try either RADIUS or LDAP and local switch authentication. The switch can also be configured to use only RADIUS, only LDAP, or only local switch authentication.

When configured to use either RADIUS or LDAP, the switch acts as a network access server (NAS) and RADIUS or LDAP client. The switch sends all authentication, authorization, and accounting (AAA) service requests to the RADIUS or LDAP server. The RADIUS or LDAP server receives the request, validates the request, and sends its response back to the switch.

The supported management access channels that integrate with RADIUS or LDAP include serial port, Telnet, SSH, Web Tools, and API. All these require the switch IP address or name to connect. RADIUS and LDAP servers accept both IPv4 and IPv6 address formats. For accessing both the active and standby CP, and for the purpose of HA failover, both CP IP addresses of a Backbone should be included in the RADIUS or LDAP server configuration.

---

**NOTE**

For systems such as the Brocade DCX Backbone, the switch IP addresses are aliases of the physical Ethernet interfaces on the CP blades. When specifying client IP addresses for the logical switches in such systems, make sure the CP IP addresses are used.

---

When configured for RADIUS or LDAP, a switch becomes a RADIUS or LDAP client. In either of these configurations, authentication records are stored in the RADIUS or LDAP host server database. Login and logout account name, assigned permissions, and time-accounting records are also stored on the RADIUS or LDAP server for each user.

By default, the RADIUS and LDAP services are disabled, so AAA services default to the switch's local database.

To enable RADIUS or LDAP service, it is strongly recommended that you access the CLI through an SSH connection so that the shared secret is protected. Multiple login sessions can configure simultaneously, and the last session to apply a change leaves its configuration in effect. After a configuration is applied, it persists after a reboot or an HA failover.

## 5 The authentication model using RADIUS and LDAP

To enable the secure LDAP service, you need to install a certificate from the Microsoft Active Directory server. By default, the LDAP service does not require certificates.

The configuration applies to all switches and on a Backbone the configuration replicates itself on a standby CP blade if one is present. It is saved in a configuration upload and applied in a configuration download.

It is recommended to configure at least two RADIUS or LDAP servers so that if one fails, the other will assume service. Up to five are supported.

You can set the configuration with either RADIUS or LDAP service and local authentication enabled so that if the RADIUS or LDAP servers do not respond due to power failure or network problems, the switch uses local authentication.

Consider the effects of the use of RADIUS or LDAP service on other Fabric OS features. For example, when RADIUS or LDAP service is enabled, all account passwords must be managed on the RADIUS or LDAP server. The Fabric OS mechanisms for changing switch passwords remain functional; however, such changes affect only the involved switches locally. They do not propagate to the RADIUS or LDAP server, nor do they affect any account on the RADIUS or LDAP server. RADIUS and LDAP servers also support notifying users of expiring passwords.

When RADIUS or LDAP is set up for a fabric that contains a mix of switches with and without RADIUS or LDAP support, the way a switch authenticates users depends on whether a RADIUS or LDAP server is set up for that switch. For a switch with RADIUS or LDAP support and configuration, authentication bypasses the local password database. For a switch without RADIUS or LDAP support or configuration, authentication uses the switch's local account names and passwords.

[Table 15](#) outlines the `aaaConfig` command options used to set up the authentication mode.

**TABLE 15 Authentication configuration options**

aaaConfig options	Description	Equivalent setting in Fabric OS v5.1.0 and earlier	
		--radius	--switchdb <sup>1</sup>
--authspec "local"	Default setting. Authenticates management connections against the local database only. If the password does not match or the user is not defined, the login fails.	Off	On
--authspec "radius"	Authenticates management connections against any RADIUS databases only. If the RADIUS service is not available or the credentials do not match, the login fails.	On	Off
--authspec "radius;local"	Authenticates management connections against any RADIUS databases first. If RADIUS fails <i>for any reason</i> , authenticates against the local user database.	not supported	not supported
--authspec "radius;local" --backup	Authenticates management connections against any RADIUS databases. If RADIUS fails because the service is not available, it then authenticates against the local user database. The --backup option directs the service to try the secondary authentication database only if the primary authentication database is not available.	On	On



**TABLE 15** Authentication configuration options (Continued)

aaaConfig options	Description	Equivalent setting in Fabric OS v5.1.0 and earlier	
		--radius	--switchdb <sup>1</sup>
--authspec "ldap"	Authenticates management connections against any LDAP databases only. If LDAP service is not available or the credentials do not match, the login fails.	n/a	n/a
--authspec "ldap; local"	Authenticates management connections against any LDAP databases first. If LDAP fails for any reason, it then authenticates against the local user database.	n/a	On
--authspec "ldap; local" --backup	Authenticates management connections against any LDAP databases first. If LDAP fails for any reason, it then authenticates against the local user database. The --backup option states to try the secondary authentication database only if the primary authentication database is not available.	n/a	On
--authspec -nologout	Prevents users from being logged out when you change authentication. Default behavior is to log users out when you change authentication.	n/a	n/a

1. Fabric OS v5.1.0 and earlier aaaConfig --switchdb <on | off> setting.

## Setting the switch authentication mode

1. Connect to the switch and log in using an account with admin permissions.
2. Enter the **aaaConfig --authspec** command.

## Fabric OS user accounts

RADIUS and LDAP servers allow you to set up user accounts by their true network-wide identity rather than by the account names created on a Fabric OS switch. With each account name, assign the appropriate switch access permissions. For LDAP servers, you can use the **ldapCfg --maprole ldap\_role name switch\_role** command to map an LDAP server permissions.

RADIUS and LDAP support all the defined RBAC roles described in [Table 11](#) on page 82.

Users must enter their assigned RADIUS or LDAP account name and password when logging in to a switch that has been configured with RADIUS or LDAP. After the RADIUS or LDAP server authenticates a user, it responds with the assigned switch role in a *Brocade Vendor-Specific Attribute* (VSA). If the response does not have a VSA permissions assignment, the User role is assigned. If no Administrative Domain is assigned, then the user is assigned to the default Admin Domain ADO.

You can set a user password expiration date and add a warning for RADIUS login. The password expiry date must be specified in UTC and in MM/DD/YYYY format. The password warning specifies the number of days prior to the password expiration that a warning of password expiration notifies the user. You either specify both attributes or none. If you specify a single attribute or there is a

syntax error in the attributes, the password expiration warning will not be issued. If your RADIUS server maintains its own password expiration attributes, you must set the exact date twice to use this feature, once on your RADIUS server and once in the VSA attribute. If the dates do not match, then the RADIUS server authentication fails.

The syntax used for assigning VSA-based account switch roles on a RADIUS server is described in [Table 16](#).

**TABLE 16** Syntax for VSA-based account roles

Item	Value	Description
Type	26	1 octet
Length	7 or higher	1 octet, calculated by the server
Vendor ID	1588	4 octet, Brocade SMI Private Enterprise Code
Vendor type	1	1 octet, Brocade-Auth-Role; valid attributes for the Brocade-Auth-Role are: Admin BasicSwitchAdmin FabricAdmin Operator SecurityAdmin SwitchAdmin User ZoneAdmin
	2	<i>Optional:</i> Specifies the Admin Domain or Virtual Fabric member list. For more information on Admin Domains or Virtual Fabrics, see <a href="#">“RADIUS configuration with Admin Domains or Virtual Fabrics”</a> on page 102. Brocade-AVPairs1
	3	Brocade-AVPairs2
	4	Brocade-AVPairs3
	5	Brocade-AVPairs4
	6	Brocade Password ExpiryDate
	7	Brocade Password ExpiryWarning
Vendor length	2 or higher	1 octet, calculated by server, including vendor-type and vendor-length
Attribute-specific data	ASCII string	Multiple octet, maximum 253, indicating the name of the assigned role and other supported attribute values such as Admin Domain member list.

## Fabric OS users on the RADIUS server

All existing Fabric OS mechanisms for managing local switch user accounts and passwords remain functional when the switch is configured to use RADIUS. Changes made to the local switch database do not propagate to the RADIUS server, nor do the changes affect any account on the RADIUS server.

### *Windows 2000 IAS*

To configure a Windows 2000 internet authentication service (IAS) server to use VSA to pass the Admin role to the switch in the dial-in profile, the configuration specifies the Vendor code (1588), Vendor-assigned attribute number (1), and attribute value (admin), as shown in [Figure 10](#).

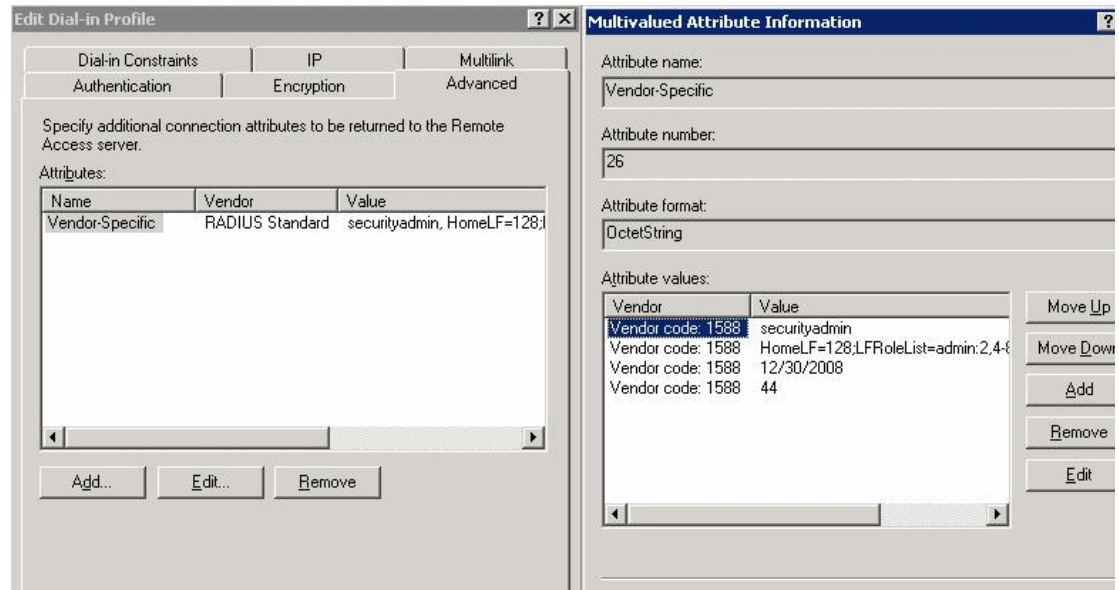

FIGURE 10 Windows 2000 VSA configuration

### *Linux FreeRadius server*

For the configuration on a Linux FreeRadius server, define the values outlined in [Table 17](#) in a vendor dictionary file called `dictionary.brocade`.

TABLE 17 Entries in `dictionary.brocade` file

Include	Key	Value
VENDOR	Brocade	1588
ATTRIBUTE	Brocade-Auth-Role	1 string Brocade
	Brocade-AVPairs1, 2, 3, 4	2, 3, 4, 5 string Admin Domain or Virtual Fabric member list
	Brocade-Passwd-ExpiryDate	6 string MM/DD/YYYY in UTC
	Brocade-Passwd-WarnPeriod	7 integer in days

After you have completed the dictionary file, define the permissions for the user in a configuration file. For example, to grant the user `jsmith` Admin permissions, you would add the following statement to the configuration file:

```
swladmin      Auth-Type := Local, User-Password == "myPassword"
              Brocade-Auth-Role = "admin",
              Brocade-AVPairs1 = "HomeLF=70",
              Brocade-AVPairs2 =
              "LFRoleList=admin:2,4-8,70,80,128;ChassisRole=admin",
              Brocade-Passwd-ExpiryDate = "11/10/2011",
              Brocade-Passwd-WarnPeriod = "30"
```

### ***RADIUS configuration with Admin Domains or Virtual Fabrics***

When configuring users with Admin Domains or Virtual Fabrics, you must also include the Admin Domain or Virtual Fabric member list. This section describes the way that you configure attribute types for this configuration.

The values for the new attribute types use the syntax *key=val[;key=val]*, where *key* is a text description of attributes, *value* is the attribute value for the given key, the equal sign (=) is the separator between key and value, and the semi-colon (;) is an optional separator for multiple key-value pairs.

Multiple key-value pairs can appear for one Vendor-Type code. Key-value pairs with the same key name may be concatenated across multiple Vendor-Type codes. You can use any combination of the Vendor-Type codes to specify key-value pairs. Note that a switch always parses these attributes from *Vendor-Type code 2* to *Vendor-Type code 4*.

Only four kinds of keys are accepted; all other keys are ignored. The following keys are accepted:

- *HomeAD* is the designated home Admin Domain for the account. The valid range of values is from 0 to 255. The first valid HomeAD key-value pair is accepted by the switch, and any additional HomeAD key-value pairs are ignored.
- *ADList* is a comma-separated list of Administrative Domain numbers to which this account is a member. Valid numbers range from 0 to 255. A dash between two numbers specifies a range. Multiple ADlist key-value pairs within the same or across the different Vendor-Type codes are concatenated. Multiple occurrences of the same Admin Domain number are ignored.
- *HomeLF* is the designated home Virtual Fabric for the account. The valid values are between 1 to 128 and chassis context. The first valid HomeLF key-value pair is accepted by the switch, additional HomeLF key-value pairs are ignored.
- *LFRoleList* is a comma-separated list of Virtual Fabric ID numbers to which this account is a member. Valid numbers range from 1 to 128. A dash between two numbers specifies a range. Multiple Virtual Fabric list key-value pairs within the same or across different Vendor-Type codes are concatenated. Multiple occurrences of the same Virtual Fabric ID number are ignored.

RADIUS authentication requires that the account have valid permissions through the attribute type Brocade-Auth-Role. The additional attribute values ADList, HomeAD, HomeLF, and LFRoleList are optional. If they are unspecified, the account can log in with ADO as its member list and home Admin Domain or VF128 as its member list and home Virtual Fabric. If there is an error in the ADlist, HomeAD, LFRoleList, or HomeLF specification, the account cannot log in until the AD list or Virtual Fabric list is corrected; an error message is displayed.

For example, on a Linux FreeRadius Server, the user (user-za) with the following settings takes the “zoneAdmin” permissions, with AD member list: 1, 2, 4, 5, 6, 7, 8, 9, 12; the Home Admin Domain will be 1.

```
user-za Auth-Type := Local, User-Password == "password"
Brocade-Auth-Role = "ZoneAdmin",
Brocade-AVPairs1 = "ADList=1,2,6,"
Brocade-AVPairs2 = "ADList=4-8;ADList=7,9,12"
```

In the next example, on a Linux FreeRadius Server, the user has the “operator” permissions, with ADList 1, 2, 4, 5, 6, 7, 8, 9, 12, 20 and HomeAD 2.

```
user-opr Auth-Type := Local, User-Password == "password"
Brocade-Auth-Role = "operator",
Brocade-AVPairs1 = "ADList=1,2;HomeAD=2",
Brocade-AVPairs2 = "ADList=-4-8,20;ADList=7,9,12"
```

In the next example, on a Linux FreeRadius Server, the user has the “zoneAdmin” permissions, with VList 2, 4, 5, 6, 7, 8, 10, 11, 12, 13, 15 17, 19, 22, 23, 24, 25, 29, 31 and HomeLF 1.

```
user300 Auth-Type := Local, User-Password == "password"
Brocade-Auth-Role = "zoneadmin",
Brocade-AVPairs1 = "HomeLF=1;LFRoleList=securityadmin:2,4-8,10"
Brocade-AVPairs2 = "LFRoleList=admin:11-13, 15, 17, 19;user:22-25,29,31"
```

## The RADIUS server

### NOTE

To set up the RADIUS server, you must know the switch IP address, in either IPv4 or IPv6 notation, or the name to connect to switches. Use the **ipAddrShow** command to display a switch IP address.

For Brocade Backbones, the switch IP addresses are aliases of the physical Ethernet interfaces on the CP blades. When specifying client IP addresses for the logical switches in these systems, make sure the CP blade IP addresses are used. For accessing both the active and standby CP blade, and for the purpose of HA failover, both of the CP blade IP addresses must be included in the RADIUS server configuration.

User accounts should be set up by their true network-wide identity rather than by the account names created on a Fabric OS switch. Along with each account name, the administrator must assign appropriate switch access permissions. To manage a fabric, these permissions can be User, Admin, and SecurityAdmin.

### *Configuring RADIUS server support with Linux*

The following procedures work for FreeRADIUS on Solaris and Red Hat Linux. FreeRADIUS is a freeware RADIUS server that you can find at the following website:

[www.freeradius.org](http://www.freeradius.org)

Follow the installation instructions at the website. FreeRADIUS runs on Linux (all versions), FreeBSD, NetBSD, and Solaris. If you make a change to any of the files used in this configuration, you must stop the server and restart it for the changes to take effect.

FreeRADIUS installation places the configuration files in `$PREFIX/etc/raddb`. By default, the PREFIX is `/usr/local`.

Configuring RADIUS service on Linux consists of the following tasks:

- Adding the Brocade attribute to the server
- Creating the user
- Enabling clients

#### **Adding the Brocade attribute to the server**

1. Create and save the file `$PREFIX/etc/raddb/dictionary.brocade` with the following information:

```
#
# dictionary.brocade
#
VENDOR Brocade 1588
#
```

## 5 The authentication model using RADIUS and LDAP

```
# attributes
#
ATTRIBUTE      Brocade-Auth-Role      1      string  Brocade
ATTRIBUTE      Brocade-AVPairs1      2      string  Brocade
ATTRIBUTE      Brocade-AVPairs2      3      string  Brocade
ATTRIBUTE      Brocade-AVPairs3      4      string  Brocade
ATTRIBUTE      Brocade-AVPairs4      5      string  Brocade
ATTRIBUTE      Brocade-Passwd-ExpiryDate 6      string  Brocade
ATTRIBUTE      Brocade-Passwd-WarnPeriod 7      string  Brocade
```

This defines the Brocade vendor ID as 1588, the Brocade attribute 1 as Brocade-Auth-Role and 6 as Brocade-Passwd-ExpiryDate, both are string values. The Brocade attribute 7 as Brocade-Passwd-WarnPeriod, and it is an integer value.

2. Open the file `$PREFIX/etc/raddb/dictionary` in a text editor and add the line:

```
$INCLUDE dictionary.brocade
```

As a result, the file `dictionary.brocade` is located in the RADIUS configuration directory and loaded for use by the RADIUS server.

### Creating the user

1. Open the `$PREFIX/etc/raddb/user` file in a text editor.
2. Add the user names and their permissions for users accessing the switch and authenticating through RADIUS.

The user will log in using the permissions specified with Brocade-Auth-Role. The valid permissions include Root, Admin, SwitchAdmin, ZoneAdmin, SecurityAdmin, BasicSwitchAdmin, FabricAdmin, Operator and User. You must use quotation marks around "password" and "role".

### Example of adding a user name to the RADIUS authentication

For example, to set up an account called JohnDoe with Admin permissions with a password expiry date of May 28, 2008 and a warning period of 30 days:

```
JohnDoe Auth-Type := Local
User-Password == "johnPassword",
Brocade-Auth-Role = "admin",
Brocade-Auth-Role = "admin",
Brocade-Passwd-ExpiryDate = "05/28/08",
Brocade-Passwd-WarnPeriod = 30
```

### Example of using the local system password to authenticate users

The next example uses the local system password file to authenticate users.

```
swadmin      Auth-Type := System
              Brocade-Auth-Role = "admin",
              Brocade-AVPairs1 = "HomeLF=70",
              Brocade-AVPairs2 = "LFRoleList=admin:2,4-8,70,80,128",
              Brocade-AVPairs3 = "ChassisRole=switchadmin",
              Brocade-Passwd-ExpiryDate = "11/10/2008",
              Brocade-Passwd-WarnPeriod = "30"
```

When you use network information service (NIS) for authentication, the only way to enable authentication with the password file is to force the Brocade switch to authenticate using password authentication protocol (PAP); this requires the `-a pap` option with the `aaaConfig` command.

### Enabling clients

Clients are the switches that will use the RADIUS server; each client must be defined. By default, all IP addresses are blocked.

The Brocade Backbones send their RADIUS requests using the IP address of the active CP. When adding clients, add both the active and standby CP IP addresses so that, in the event of a failover, users can still log in to the switch.

1. Open the `$PREFIX/etc/raddb/client.config` file in a text editor and add the switches that are to be configured as RADIUS clients.

For example, to configure the switch at IP address 10.32.170.59 as a client:

```
client 10.32.170.59
    secret      = Secret
    shortname   = Testing Switch
    nastype     = other
```

In this example, *shortname* is an alias used to easily identify the client. *Secret* is the shared secret between the client and server. Make sure the shared secret matches that configured on the switch (see [“Adding a RADIUS or LDAP server to the switch configuration”](#) on page 112).

2. Save the file `$PREFIX/etc/raddb/client.config` then start the RADIUS server as follows:

```
$PREFIX/sbin/radiusd
```

### *Configuring RADIUS server support with Windows 2000*

The instructions for setting up RADIUS on a Windows 2000 server are listed here for your convenience but are not guaranteed to be accurate for your network environment. Always check with your system administrator before proceeding with setup.

---

#### NOTE

All instructions involving Microsoft Windows 2000 can be obtained from [www.microsoft.com](http://www.microsoft.com) or your Microsoft documentation. Confer with your system or network administrator prior to configuration for any special needs your network environment may have.

---

Configuring RADIUS service on Windows 2000 consists of the following steps:

1. Installing internet authentication service (IAS)

For more information and instructions on installing IAS, refer to the Microsoft website.

2. Enabling the Challenge Handshake Authentication Protocol (CHAP)

If CHAP authentication is required, then Windows must be configured to store passwords with reversible encryption. Reverse password encryption is not the default behavior; it must be enabled.

---

#### NOTE

If a user is configured prior to enabling reverse password encryption, then the user's password is stored and cannot utilize CHAP. To use CHAP, the password must be re-entered after encryption is enabled. If the password is not re-entered, then CHAP authentication will not work and the user will be unable to authenticate from the switch.

Alternatives to using CHAP are Password Authentication Protocol (PAP), or PEAP-MS-CHAP-v2.

---

### 3. Configuring a user

IAS is the Microsoft implementation of a RADIUS server and proxy. IAS uses the Windows native user database to verify user login credentials; it does not list specific users, but instead lists *user groups*. Each user group should be associated with specific switch role. For example, you should configure a user group for root, admin, factory, switchAdmin, and user, and then add any users whose logins you want to associate to the appropriate group.

### 4. Configuring the server

For more information and instructions on configuring the server, refer to the Microsoft website. Below is the information you will need to configure the RADIUS server for a Brocade switch. A client is the device that uses the RADIUS server; in this case, it is the switch.

#### a. For the Add RADIUS Client window, provide the following:

Client address (IP or DNS)—Enter the IP address of the switch.

Client-Vendor—Select **RADIUS Standard**.

Shared secret—Provide a password. Shared secret is a password used between the client device and server to prevent IP address spoofing by unwanted clients. Keep your shared secret password in a safe place. You will need to enter this password in the switch configuration.

After clicking Finish, add a new client for all switches on which RADIUS authentication will be used.

#### b. In the Internet Authentication Service window, right-click the Remote Access Policies folder; then select **New Remote Access Policy** from the pop-up window.

A remote access policy must be created for each group of Brocade login permissions (Root, Admin, Factory, SwitchAdmin, and User) for which you want to use RADIUS. Apply this policy to the user groups that you already created.

#### c. In the Vendor-Specific Attribute Information window, enter the vendor code value **1588**. Click the **Yes. It conforms** radio button and then click **Configure Attribute**.

#### d. In the Configure VSA (RFC compliant) window, enter the following values and click **OK**.

Vendor-assigned attribute number—Enter the value **1**.

Attribute format—Enter **String**.

Attribute value—Enter the login role (Root, Admin, SwitchAdmin, User, etc.) the user group must use to log in to the switch.

#### e. After returning to the Internet Authentication Service window, add additional policies for all Brocade login types for which you want to use the RADIUS server. After this is done, you can configure the switch.

---

#### NOTE

Windows 2008 RADIUS (NPS) support is also available.

---

### ***RSA RADIUS server***

Traditional password-based authentication methods are based on *one-factor* authentication, where you confirm your identity using a memorized password. Two-factor authentication increases the security by using a second factor to corroborate identification. The first factor is either a PIN or password and the second factor is the RSA SecurID token.



RSA SecurID with an RSA RADIUS server is used for user authentication. The Brocade switch does not communicate directly with the RSA Authentication Manager, so the RSA RADIUS server is used in conjunction with the switch to facilitate communication.

To learn more about how RSA SecurID works, visit [www.rsa.com](http://www.rsa.com) for more information.

### Setting up the RSA RADIUS server

For more information on how to install and configure the RSA Authentication Manager and the RSA RADIUS server, refer to your documentation or visit [www.rsa.com](http://www.rsa.com).

1. Create user records in the RSA Authentication Manager.
2. Configure the RSA Authentication Manager by adding an agent host.
3. Configure the RSA RADIUS server.

Setting up the RSA RADIUS server involves adding RADIUS clients, users, and vendor specific attributes to the RSA RADIUS server.

- a. Add the following data to the `vendor.ini` file:

```
vendor-product = Brocade
```

```
dictionary = brocade
```

```
ignore-ports = no
```

```
port-number-usage = per-port-type
```

```
help-id = 2000
```

- b. Create a `brocade.dct` file that needs to be added into the `dictionary.dcm` file located in the following path:

```
C:\Program Files\RSA Security\RSA RADIUS\Service
```

[Figure 11](#) on page 108 shows what the `brocade.dct` file should look like and [Figure 12](#) on page 108 shows what needs to be modified in the `brocade.dcm` file.

---

#### NOTE

The dictionary files for RSA RADIUS Server must remain in the installation directory. Do not move the files to other locations on your computer.

---

Add `Brocade-VSA macro` and define the attributes as follows:

- vid (Vendor-ID): 1588
- type1 (Vendor-Type): 1
- len1 (Vendor-Length): >=2

## 5 The authentication model using RADIUS and LDAP

```
#####
# brocade.dct -- Brocade Dictionary
#
# (See readme.dct for more details on the format of this file)
#####
#
# Use the Radius specification attributes in lieu of the Brocade one:
#
@radius.dct

MACRO Brocade-VSA(t,s) 26 [vid=1588 type1=%t% len1=+2 data=%s%]

ATTRIBUTE Brocade-Auth-Role Brocade-VSA(1,string) r
ATTRIBUTE Brocade-Passwd-ExpiryDate Brocade-VSA(6,string) r
ATTRIBUTE Brocade-Passwd-WarnPeriod Brocade-VSA(7,integer) r

#####
# brocade.dct -- Brocade Dictionary
#####
```

FIGURE 11 Example of a Brocade DCT file

```
#####
# dictiona.dcm
#####

# Generic Radius

@radius.dct

#
# Specific Implementations (vendor specific)
#
@3comsw.dct
@aat.dct
@acc.dct
@accessbd.dct
@agere.dct
@agns.dct
@airespace.dct
@alcatel.dct
@altiga.dct
@annex.dct
@aptis.dct
@ascend.dct
@ascndvsa.dct
@axc.dct
@bandwagn.dct
@brocade.dct <-----
```

FIGURE 12 Example of the dictiona.dcm file

- c. When selecting items from the **Add Return List Attribute**, select *Brocade-Auth-Role* and type the string *Admin*. The string will equal the role on the switch.

- d. Add the Brocade profile.
- e. In **RSA Authentication Manager**, edit the user records that will be authenticating using RSA SecurID.

## LDAP configuration and Microsoft Active Directory

LDAP provides user authentication and authorization using the Microsoft Active Directory service in conjunction with LDAP on the switch. There are two modes of operation in LDAP authentication, FIPS mode and non-FIPS mode. This section discusses LDAP authentication in non-FIPS mode. For more information on LDAP in FIPS mode, refer to [Chapter 7, “Configuring Security Policies”](#). The following are restrictions when using LDAP in non-FIPS mode:

- There is no password change through Active Directory.
- There is no automatic migration of newly created users from the local switch database to Active Directory. This is a manual process explained later.
- Only IPv4 is supported for LDAP on Windows 2000 and LDAP on Windows Server 2003. For LDAP on Windows Server 2008, both IPv4 and IPv6 are supported.
- LDAP authentication is used on the local switch only and not for the entire fabric.
- You can use the User-Principal-Name and not the Common-Name for AD LDAP authentication.

To provide backward compatibility, authentication based on the Common Name is still supported for Active Directory LDAP 2000 and 2003. Common Name based-authentication is not recommended for new installations.

- A user can belong to multiple groups as long as one of the groups is the primary group. The primary group in the AD server should not be set to the group corresponding to the switch role. You can choose any other group.
- A user can be part of any Organizational Unit (OU).
- Active Directory LDAP 2000, 2003, and 2008 is supported.

Roles for Brocade-specific users can be added through the Microsoft Management Console. Groups created in Active Directory must correspond directly to the RBAC user roles on the switch. Role assignments can be achieved by including the user in the respective group. A user can be assigned to multiple groups like Switch Admin and Security Admin. For LDAP servers, you can use the `ldapCfg --maprole ldap_role_name switch_role` command to map an LDAP server permissions to one of the default roles available on a switch. For more information on RBAC roles, see [“Role-Based Access Control”](#) on page 82.

---

### NOTE

All instructions involving Microsoft Active Directory can be obtained from [www.microsoft.com](http://www.microsoft.com) or your Microsoft documentation. Confer with your system or network administrator prior to configuration for any special needs your network environment may have.

---

Following is the overview of the process used to set up LDAP:

1. If your Windows Active Directory server for LDAP needs to be verified by the LDAP client (that is, the Brocade switch), then you must install a Certificate Authority (CA) certificate on the Windows Active Directory server for LDAP.  
  
Follow Microsoft instructions for generating and installing CA certificates on a Windows server.
2. Create a user in Microsoft Active Directory server.

## 5 The authentication model using RADIUS and LDAP

For instructions on how to create a user, refer to [www.microsoft.com](http://www.microsoft.com) or Microsoft documentation to create a user in your Active Directory.

3. Create a group name that uses the switch's role name so that the Active Directory group's name is the same as the switch's role name.

or

Use the `ldapCfg --maprole ldap_role_name switch_role` command to map an LDAP server role to one of the default roles available on the switch.

4. Associate the user to the group by adding the user to the group.

For instructions on how to create a user refer to [www.microsoft.com](http://www.microsoft.com) or Microsoft documentation to create a user in your Active Directory.

5. Add the user's Administrative Domains or Virtual Fabrics to the CN\_list by either editing the `adminDescription` value or adding the `brcdAdvfData` attribute to the existing Active Directory schema.

This action maps the Admin Domains or Virtual Fabrics to the user name. Multiple Admin Domains can be added as a string value separated by the underscore character ( `_` ). Virtual Fabrics are added as a string value separate by a colon ( `,` ) and entered as a range.

### *Creating a user*

To create a user in Active Directory, refer to [www.microsoft.com](http://www.microsoft.com) or Microsoft documentation. There are no special attributes to set. You can use a fully qualified name for logging in, for example you can log in as "user@domain.com".

### *Creating a group*

To create a group in Active Directory, refer to [www.microsoft.com](http://www.microsoft.com) or Microsoft documentation. You will need to verify that the group has the following attributes:

- The name of the group has to match the RBAC role.
- The Group Type must be *Security*.
- The Group Scope must be *Global*.
- The primary group in the AD server should not be set to the group corresponding to the switch role. You can choose any other group.
- If the user you created is not a member of the Users OU then the User Principal Name, in the format of "user@domain", is required to login.

### *Assigning the group (role) to the user*

To assign the user to a group in Active Directory, refer to [www.microsoft.com](http://www.microsoft.com) or Microsoft documentation. You will need to verify that the user has the following attributes:

- Update the **memberOf** field with the login permissions (Root, Admin, SwitchAdmin, User, etc.) that the user must use to log in to the switch.

or

If you have a user-defined group, then use the `ldapCfg --maprole ldap_role_name switch_role` command to map an LDAP server permissions to one of the default roles available on a switch.

### *Adding an Admin Domain or Virtual Fabric list*

1. From the Windows Start menu, select **Programs> Administrative Tools> ADSI.msc**  
 ADSI is a Microsoft Windows Resource Utility. This will need to be installed to proceed with the rest of the setup. For Windows 2003, this utility comes with Service Pack 1 or you can download this utility from the Microsoft website.
2. Go to **CN=Users**.
3. Right click on select **Properties**. Click the **Attribute Editor** tab.
4. Double-click the **adminDescription** attribute.  
 This opens the String Attribute Editor dialog box.
5. Perform the appropriate action based on whether you are using Administrative Domains or Virtual Fabrics:
  - If you are using Administrative Domains, enter the value of the Admin Domain separated by an underscore ( **\_** ) into the **Value** field.  
**Example for adding Admin Domains**  
`adlist_0_10_200_endAd`  
 Home Admin Domain (homeAD) for the user will be the first value in the *adlist* (Admin Domain list). If a user has no values assigned in the *adlist* attribute, then the homeAD '0' will be the default administrative domain for the user.
  - If you are using Virtual Fabrics, enter the value of the logical fabric separated by an semi-colon ( **;** ) into the **Value** field.  
**Example for adding Virtual Fabrics**  
`HomeLF=10;LFRoleList=admin:128,10;ChassisRole=admin`  
 In this example, the logical switch that would be logged into by default is 10. If 10 is not available then the lowest FID available will be chosen. You would have permission to enter logical switch 128 and 10 in an admin role and you would also have the chassis role permission of admin.

---

#### **NOTE**

You can perform batch operations using the *Ldifde.exe* utility. For more information on importing and exporting schemas, refer to your Microsoft documentation or visit [www.microsoft.com](http://www.microsoft.com).

---

### *Adding attributes to the Active Directory schema*

To create a group in Active Directory, refer to [www.microsoft.com](http://www.microsoft.com) or Microsoft documentation. You will need to verify that the schema has the following attributes:

- Add a new attribute **brcdAdVfData** as Unicode String.
- Add **brcdAdVfData** to the person's properties.

## Authentication servers on the switch

At least one RADIUS or LDAP server must be configured before you can enable RADIUS or LDAP service. You can configure the RADIUS or LDAP service even if it is disabled on the switch. You can configure up to five RADIUS or LDAP servers. You must be logged in as admin or switchAdmin to configure the RADIUS service.

---

### NOTE

On dual-CP Backbones (Brocade DCX and DCX-4S devices), the switch sends its RADIUS or LDAP request using the IP address of the active CP. When adding clients, add both the active and standby CP IP addresses so that users can still log in to the switch in the event of a failover.

---

RADIUS or LDAP configuration is chassis-based configuration data. On platforms containing multiple switch instances, the configuration applies to all instances. The configuration is persistent across reboots and firmware downloads. On a chassis-based system, the command must replicate the configuration to the standby CP.

Multiple login sessions can invoke the command simultaneously. The last session that applies the change is the one whose configuration is in effect. This configuration is persistent after an HA failover.

The RADIUS or LDAP servers are contacted in the order they are listed, starting from the top of the list and moving to the bottom.

### *Adding a RADIUS or LDAP server to the switch configuration*

1. Connect to the switch and log in using an account with admin permissions.
2. Enter the **aaaConfig --add** command.

At least one RADIUS or LDAP server must be configured before you can enable the RADIUS or LDAP service.

If no RADIUS or LDAP configuration exists, turning on the RADIUS authentication mode triggers an error message. When the command succeeds, the event log indicates that the configuration is enabled or disabled.

### *Enabling and disabling a RADIUS or LDAP server*

1. Connect to the switch and log in using an account with admin permissions.
2. Enter the **aaaConfig --authspec** command to enable RADIUS or LDAP using the local database.

You must specify the type of server as either RADIUS or LDAP, but not both. Local is used for local authentication if the user authentication fails on the RADIUS or LDAP server.

#### **Example of enabling RADIUS**

```
switch:admin> aaaconfig --authspec "radius;local" --backup
```

### *Deleting a RADIUS or LDAP server from the configuration*

1. Connect to the switch and log in using an account with admin permissions.
2. Enter the **aaaConfig --remove** command.

When the command succeeds, the event log indicates that the server is removed.

### *Changing a RADIUS or LDAP server configuration*

1. Connect to the switch and log in using an account with admin permissions.
2. Enter the `aaaConfig --change` command.

### *Changing the order in which RADIUS or LDAP servers are contacted for service*

1. Connect to the switch and log in using an account with admin permissions.
2. Enter the `aaaConfig --move` command.

When the command succeeds, the event log indicates that a server configuration is changed.

### *Displaying the current RADIUS configuration*

1. Connect to the switch and log in using an account with admin permissions.
2. Enter the `aaaConfig --show` command.

If a configuration exists, its parameters are displayed. If RADIUS or LDAP service is not configured, only the parameter heading line is displayed. Parameters include:

Position	The order in which servers are contacted to provide service.
Server	The server names or IPv4 or IPv6 addresses. IPv6 is not supported when using PEAP authentication.
Port	The server ports.
Secret	The shared secrets.
Timeouts	The length of time servers have to respond before the next server is contacted.
Authentication	The type of authentication being used on servers.

## Configuring local authentication as backup

It is useful to enable local authentication so that the switch can take over authentication locally if the RADIUS or LDAP servers fail to respond because of power outage or network problems.

#### Example of enabling local authentication, enter the following command for RADIUS

```
switch:admin> aaaconfig --authspec "radius;local" --backup
```

#### Example for LDAP

```
switch:admin> aaaconfig --authspec "ldap;local" --backup
```

For details about this command see [Table 15](#) on page 98.

When local authentication is enabled and the RADIUS or LDAP servers fail to respond, you can log in to the default switch accounts (admin and user) or any user-defined account. You must know the passwords of these accounts.

When the command succeeds, the event log indicates that local database authentication is disabled or enabled.

## 5 The authentication model using RADIUS and LDAP



# Configuring Protocols

---

## In this chapter

- Security protocols ..... 115
- Secure Copy ..... 116
- Secure Shell protocol ..... 117
- Secure Sockets Layer protocol ..... 120
- Simple Network Management Protocol ..... 125
- Telnet protocol ..... 127
- Listener applications ..... 129
- Ports and applications used by switches ..... 129

## Security protocols

Security protocols provide endpoint authentication and communications privacy using cryptography. Typically, you are authenticated to the switch while the switch remains unauthenticated to you. This means that you can be sure with what you are communicating. The next level of security, in which both ends of the conversation are sure with whom they are communicating, is known as two-factor authentication. Two-factor authentication requires public key infrastructure (PKI) deployment to clients.

Fabric OS supports the secure protocols shown in [Table 18](#).

**TABLE 18** Secure protocol support

Protocol	Description
HTTPS	HTTPS is a Uniform Resource Identifier scheme used to indicate a secure HTTP connection. Web Tools supports the use of hypertext transfer protocol over secure socket layer (HTTPS).
IPsec	Internet Protocol Security (IPsec) is a framework of open standards for providing confidentiality, authentication and integrity for IP data transmitted over untrusted links or networks.
LDAPS	Lightweight Directory Access Protocol over SSL uses a certificate authority (CA). By default, LDAP traffic is transmitted unsecured. You can make LDAP traffic confidential and secure by using Secure Sockets Layer (SSL) / Transport Layer Security (TLS) technology in conjunction with LDAP.
SCP	Secure Copy (SCP) is a means of securely transferring computer files between a local and a remote host or between two remote hosts, using the Secure Shell (SSH) protocol. Configuration upload and download support the use of SCP.
SNMP	SNMP is used in network management systems to monitor network-attached devices for conditions that warrant administrative attention. Supports SNMPv1, v2, and v3.

**TABLE 18** Secure protocol support (Continued)

Protocol	Description
SSH	Secure Shell (SSH) is a network protocol that allows data to be exchanged over a secure channel between two computers. Encryption provides confidentiality and integrity of data. SSH uses public-key cryptography to authenticate the remote computer and allow the remote computer to authenticate the user, if necessary.
SSL	Fabric OS uses secure socket layer (SSL) to support HTTPS. A certificate must be generated and installed on each switch to enable SSL. Supports SSLv3, 128-bit encryption by default.

[Table 19](#) describes additional software or certificates that you must obtain to deploy secure protocols.

**TABLE 19** Items needed to deploy secure protocols

Protocol	Host side	Switch side
SSHv2	Secure shell client	None
HTTPS	No requirement on host side except a browser that supports HTTPS	Switch IP certificate for SSL
SCP	SSH daemon, SCP server	None
SNMPv1, SNMPv2, SNMPv3	None	None

The security protocols are designed with the four main use cases described in [Table 20](#).

**TABLE 20** Main security scenarios

Fabric	Management interfaces	Comments
Nonsecure	Nonsecure	No special setup is needed to use Telnet or HTTP.
Nonsecure	Secure	Secure protocols may be used. An SSL switch certificate must be installed if HTTPS is used.
Secure	Secure	Switches running earlier Fabric OS versions can be part of the secure fabric, but they do not support secure management. Secure management protocols must be configured for each participating switch. Nonsecure protocols may be disabled on nonparticipating switches. If SSL is used, then certificates must be installed. For more information on installing certificates, refer to <a href="#">"Installing a switch certificate"</a> on page 123.
Secure	Nonsecure	You must use SSH because Telnet is not allowed with some features.

## Secure Copy

The secure copy protocol (SCP) runs on port 22. It encrypts data during transfer, thereby avoiding packet sniffers that attempt to extract useful information during data transfer. SCP relies on SSH to provide authentication and security.

### Setting up SCP for configuration uploads and downloads

1. Connect to the switch and log in using an account with admin permissions.
2. Type the **configure** command.

3. Type **y** or **yes** at the **cfgload attributes** prompt.
4. Type **y** or **yes** at the **Enforce secure configUpload/Download** prompt.

#### Example of setting up SCP for configUpload/download

```
switch:admin> configure
```

Not all options will be available on an enabled switch.  
To disable the switch, use the "switchDisable" command.

Configure...

```
System services (yes, y, no, n): [no] n
ssl attributes (yes, y, no, n): [no] n
http attributes (yes, y, no, n): [no] n
snmp attributes (yes, y, no, n): [no] n
rpcd attributes (yes, y, no, n): [no] n
cfgload attributes (yes, y, no, n): [no] y
```

```
Enforce secure config Upload/Download (yes, y, no, n): [no] y
Enforce signature validation for firmware (yes, y, no, n): [no]
```

## Secure Shell protocol

To ensure security, Fabric OS supports secure shell (SSH) encrypted sessions. SSH encrypts all messages, including the client transmission of the password during login. The SSH package contains a daemon (sshd), which runs on the switch. The daemon supports a wide variety of encryption algorithms, such as Blowfish-Cipher block chaining (CBC) and Advanced Encryption Standard (AES).

---

### NOTE

To maintain a secure network, you should avoid using Telnet or any other unprotected application when you are working on the switch.

---

Commands that require a secure login channel must originate from an SSH session. If you start an SSH session, and then use the **login** command to start a nested SSH session, commands that require a secure channel will be rejected.

Fabric OS supports OpenSSH protocol v2.0 (ssh2). For more information on SSH, refer to the SSH IETF website:

<http://www.ietf.org/ids.by.wg/secsh.html>

You can also refer to *SSH, The Secure Shell: The Definitive Guide* by Daniel J. Barrett, Ph. D., Richard E. Silverman, and Robert G. Byrnes.

## SSH public key authentication

OpenSSH public key authentication provides password-less logins, known as SSH authentication, that uses public and private key pairs for incoming and outgoing authentication. This feature allows only one *allowed-user* to be configured to utilize outgoing OpenSSH public key authentication. Any admin user can perform incoming Open SSH public key authentication. Using OpenSSH RSA and

DSA, the authentication protocols are based on a pair of specially generated cryptographic keys, called the private key and the public key. The advantage of using these key-based authentication systems is that in many cases, it is possible to establish secure connections without having to depend on passwords for security. RSA asynchronous algorithms are FIPS-compliant.

Incoming authentication is used when the remote host needs to authenticate to the switch. Outgoing authentication is used when the switch needs to authenticate to a server or remote host, such as when running the **configUpload** or **configDownload** commands, or performing firmware download. Both password and public key authentication can coexist on the switch.

### *Allowed-user*

For outgoing authentication, the default admin user must set up the allowed-user with admin permissions. By default, the admin is the configured *allowed-user*. While creating the key pair, the configured *allowed-user* can choose a passphrase with which the private key is encrypted. Then the passphrase must always be entered when authenticating to the switch. The *allowed-user* must have admin permissions to perform OpenSSH public key authentication, import and export keys, generate a key pair for an outgoing connection, and delete public and private keys.

### *Configuring incoming SSH authentication*

1. Log in to your remote host.
2. Generate a key pair for host-to-switch (incoming) authentication by verifying that SSH v2 is installed and working (refer to your host's documentation as necessary) by typing the following command:

```
ssh-keygen -t dsa
```

#### **Example of RSA/DSA key pair generation**

```
anyuser@mymachine: ssh-keygen -t dsa
Generating public/private dsa key pair.
Enter file in which to save the key (/users/anyuser/.ssh/id_dsa) :
Enter passphrase (empty for no passphrase) :
Enter same passphrase again:
Your identification has been saved in /users/anyuser/.ssh/id_dsa.
Your public key has been saved in /users/anyuser/.ssh/id_dsa.pub.
The key fingerprint is:
32:9f:ae:b6:7f:7e:56:e4:b5:7a:21:f0:95:42:5c:d1 anyuser@mymachine
```

3. Import the public key to the switch by logging in to the switch as any user with the Admin role and entering the **sshUtil importpubkey** command to import the key.

#### **Example of adding the public key to the switch**

```
switch:anyuser> sshutil importpubkey
Enter user name for whom key is imported: aswitchuser
Enter IP address:192.168.38.244
Enter remote directory:~auser/.ssh
Enter public key name(must have .pub suffix):id_dsa.pub
Enter login name:auser
Password:
Public key is imported successfully.
```

4. Test the setup by logging into the switch from a remote device, or by running a command remotely using ssh.

## *Configuring outgoing SSH authentication*

After the allowed-user is configured, the remaining setup steps must be completed by the allowed-user. To configure outgoing authentication, follow these steps:

1. Log in to the switch as the default admin.
2. Change the allowed-user's permissions to admin, if applicable.

```
switch:admin> userconfig --change username -r admin
```

Where *username* is the name of the user you want to perform SSH public key authentication, import, export, and delete keys.

3. Set up the allowed-user by typing the following command:

```
switch:admin> sshutil allowuser username
```

Where *username* is the name of the user you want to perform SSH public key authentication, import, export, and delete keys.

4. Generate a key pair for switch-to-host (outgoing) authentication by logging in to the switch as the allowed user and entering the **sshUtil genkey** command.

You may enter a passphrase for additional security.

### **Example of generating a key pair on the switch**

```
switch:alloweduser> sshutil genkey
Enter passphrase (empty for no passphrase):
Enter same passphrase again:
Key pair generated successfully.
```

5. Export the public key to the host by logging in to the switch as the allowed-user and entering the **sshUtil exportpubkey** command to export the key.

### **Example of exporting a public key from the switch**

```
switch:alloweduser> sshutil exportpubkey
Enter IP address:192.168.38.244
Enter remote directory:~auser/.ssh
Enter login name:auser
Password:
public key out_going.pub is exported successfully.
```

6. Append the public key to a remote host by logging in to the remote host, locating the directory where authorized keys are stored, and appending the public key to the file.

You may need to refer to the host's documentation to locate where the authorized keys are stored.

7. Test the setup by using a command that uses SCP and authentication, such as **firmwareDownload** or **configUpload**.

## *Deleting public keys on the switch*

1. Connect to the switch and log in using an account with admin permissions.
2. Use the **sshUtil delpubkeys** command to delete public keys.

You will be prompted to enter the name of the user whose the public keys you want to delete. Enter **all** to delete public keys for all users.

For more information on IP Filter policies, refer to [Chapter 7, "Configuring Security Policies"](#).

### *Deleting private keys on the switch*

1. Log in to the switch as the allowed-user.
2. Use the `sshUtil delprivkey` command to delete the private key.

For more information on IP Filter policies, refer to [Chapter 7, “Configuring Security Policies”](#).

## Secure Sockets Layer protocol

Secure sockets layer (SSL) protocol provides secure access to a fabric through Web-based management tools like Web Tools. SSL support is a standard Fabric OS feature.

Switches configured for SSL grant access to management tools through hypertext transfer protocol over SSL links (which begin with `https://`) instead of standard links (which begin with `http://`).

SSL uses public key infrastructure (PKI) encryption to protect data transferred over SSL connections. PKI is based on digital certificates obtained from an Internet Certificate Authority (CA) that acts as the trusted key agent.

Certificates are based on the switch IP address or fully qualified domain name (FQDN), depending on the issuing CA. If you change a switch IP address or FQDN after activating an associated certificate, you may have to obtain and install a new certificate. Check with the CA to verify this possibility, and plan these types of changes accordingly.

### Browser and Java support

Fabric OS supports the following Web browsers for SSL connections:

- Internet Explorer v7.0 (Microsoft Windows)
- Mozilla Firefox v2.0 (Solaris and Red Hat Linux)

---

#### NOTE

Review the release notes for the latest information and to verify if your platform and browser are supported.

---

In countries that allow the use of 128-bit encryption, you should use the latest version of your browser. For example, Internet Explorer 7.0 and later supports 128-bit encryption by default. You can display the encryption support (called “cipher strength”) using the Internet Explorer **Help>About** menu option. If you are running an earlier version of Internet Explorer, you may be able to download an encryption patch from the Microsoft website at <http://www.microsoft.com>.

You should upgrade to the Java 1.6.0 Plug-in on your management workstation. To find the Java version that is currently running, open the Java console and look at the first line of the window. For more details on levels of browser and Java support, see the *Web Tools Administrator’s Guide*.

### SSL configuration overview

You configure for SSL by obtaining, installing, and activating digital certificates for SSL support. Certificates are required on all switches that are to be accessed through SSL.

Also, you must install a certificate in the Java Plug-in on the management workstation, and you may need to add a certificate to your Web browser.

Configuring for SSL involves these main steps, which are shown in detail in the next sections.

1. Choose a certificate authority (CA).
2. Generate the following items on each switch:
  - a. A public and private key by using the **secCertUtil genkey** command.
  - b. A certificate signing request (CSR) by using the **secCertUtil gencsr** command.
3. Store the CSR on a file server by using the **secCertUtil export** command.
4. Obtain the certificates from the CA.

You can request a certificate from a CA through a Web browser. After you request a certificate, the CA either sends certificate files by e-mail (public) or gives access to them on a remote host (private). Typically, the CA provides the certificate files listed in [Table 21](#). Brocade supports .pem, .crt, and .cer files from the Certificate Authority.

**TABLE 21** SSL certificate files

Certificate file	Description
<i>name.crt</i>	The switch certificate.
<i>nameRoot.crt</i>	The root certificate. Typically, this certificate is already installed in the browser, but if not, you must install it.
<i>nameCA.crt</i>	The CA certificate. It must be installed in the browser to verify the validity of the server certificate or server validation fails.

5. On each switch, install the certificate. Once the certificate is loaded on the switch, HTTPS starts automatically.
6. If necessary, install the root certificate to the browser on the management workstation.
7. Add the root certificate to the Java Plug-in keystore on the management workstation.

## Certificate authorities

To ease maintenance and allow secure out-of-band communication between switches, consider using one certificate authority (CA) to sign all management certificates for a fabric. If you use different CAs, management services operate correctly, but the Web Tools **Fabric Events** button is unable to retrieve events for the entire fabric.

Each CA (for example, Verisign or GeoTrust) has slightly different requirements; for example, some generate certificates based on IP address, while others require an FQDN, and most require a 1024-bit public/private key while some may accept a 2048-bit key. Consider your fabric configuration, check CA websites for requirements, and gather all the information that the CA requires.

### *Generating a public and private key*

Perform this procedure on each switch.

1. Connect to the switch and log in using an account with admin permissions.
2. Enter the **secCertUtil genkey** command to generate a public/private key pair.

The system reports that this process will disable secure protocols, delete any existing CSR, and delete any existing certificates.

3. Respond to the prompts to continue and select the key size.

### Example of generating a key

```
Continue (yes, y, no, n): [no] y
Select key size [1024 or 2048]: 1024
Generating new rsa public/private key pair
Done.
```

Because CA support for the 2048-bit key size is limited, you should select 1024 in most cases.

## *Generating and storing a CSR*

After generating a public/private key, perform this procedure on each switch.

1. Connect to the switch and log in using an account with admin permissions.
2. Enter the **secCertUtil gencsr** command.
3. Enter the requested information.

### Example of generating a CSR

```
Country Name (2 letter code, eg, US):US
State or Province Name (full name, eg, California):California
Locality Name (eg, city name):San Jose
Organization Name (eg, company name):Brocade
Organizational Unit Name (eg, department name):Eng
Common Name (Fully qualified Domain Name, or IP address): 192.1.2.3
Generating CSR, file name is: 192.1.2.3.csr
Done.
```

Your CA may require specific codes for Country, State or Province, Locality, Organization, and Organizational Unit names. Make sure that your spelling is correct and matches the CA requirements. If the CA requires that the Common Name be specified as an FQDN, make sure that the fully qualified domain name is set on the domain name server. The IP address or FQDN will be the switch where the certificate will be put on.

4. Enter the **secCertUtil export** command to store the CSR:
5. Enter the requested information. You can use either FTP or SCP.

### Example of exporting a CSR

```
Select protocol [ftp or scp]: ftp
Enter IP address: 192.1.2.3
Enter remote directory: path_to_remote_directory
Enter Login Name: your account
Enter Password: your password
Success: exported CSR.
```

If you are set up for secure file copy protocol, you can select it; otherwise, select ftp. Enter the IP address of the switch on which you generated the CSR. Enter the remote directory name of the FTP server to which the CSR is to be sent. Enter your account name and password on the server.



### *Obtaining certificates*

Check the instructions on the CA website; then, perform this procedure for each switch.

1. Generate and store the CSR as described in “Generating and storing a CSR” on page 122.
2. Open a Web browser window on the management workstation and go to the CA website. Follow the instructions to request a certificate. Locate the area in the request form into which you are to paste the CSR.
3. Through a Telnet window, connect to the switch and log in using an account with admin permissions.
4. Enter the **secCertUtil showcsr** command. The contents of the CSR are displayed.
5. Locate the section that begins with “BEGIN CERTIFICATE REQUEST” and ends with “END CERTIFICATE REQUEST”.
6. Copy and paste this section (including the BEGIN and END lines) into the area provided in the request form; then, follow the instructions to complete and send the request.

It may take several days to receive the certificates. If the certificates arrive by e-mail, save them to an FTP server. If the CA provides access to the certificates on an FTP server, make note of the path name and make sure you have a login name and password on the server.

### *Installing a switch certificate*

Perform this procedure on each switch.

1. Connect to the switch and log in using an account with admin permissions.
2. Enter the **secCertUtil import** command.
3. Select a protocol, enter the IP address of the host on which the switch certificate is saved, and enter your login name and password.

#### **Example of installing a switch certificate**

```
switch:admin> seccertutil import -config swcert -enable https
Select protocol [ftp or scp]: ftp
Enter IP address: 192.10.11.12
Enter remote directory: path_to_remote_directory
Enter certificate name (must have ".crt", ".cer", \
or ".pem" suffix): 192.1.2.3.crt
Enter Login Name: your_account
Enter Password: *****
Success: imported certificate [192.1.2.3.crt].
```

Once the certificate is loaded on the switch, HTTPS starts automatically.

## **The browser**

The root certificate may already be installed on your browser, if not, you must install it. To see whether it is already installed, check the certificate store on your browser.

The next procedures are guides for installing root certificates to Internet Explorer and Mozilla Firefox browsers. For more detailed instructions, refer to the documentation that came with the certificate.

### *Checking and installing root certificates on Internet Explorer*

1. Select **Tools > Internet Options**.
2. Click the **Content** tab.
3. Click **Certificates**.
4. Click the **Intermediate** or **Trusted Root** tabs and scroll the list to see if the root certificate is listed. Take the appropriate following action based on whether you find the certificate:
  - If the certificate is listed, you do not need to install it. You can skip the rest of this procedure.
  - If the certificate is not listed, click **Import**.
5. Follow the instructions in the Certificate Import wizard to import the certificate.

### *Checking and installing root certificates on Mozilla Firefox*

1. Select **Tools > Options**.
2. Click **Advanced**.
3. Click the **Encryption** tab.
4. Click **View Certificates > Authorities** tab and scroll the list to see if the root certificate is listed. For example, its name may have the form *nameRoot.crt*. Take the appropriate following action based on whether you find the certificate:
  - If the certificate is listed, you do not need to install it. You can skip the rest of this procedure.
  - If the certificate is not listed, click **Import**.
5. Browse to the certificate location and select the certificate. For example, select *nameRoot.crt*.
6. Click **Open** and follow the instructions to import the certificate.

## Root certificates for the Java Plug-in

For information on Java requirements, see “[Browser and Java support](#)” on page 120.

This procedure is a guide for installing a root certificate to the Java Plug-in on the management workstation. If the root certificate is not already installed to the plug-in, you should install it. For more detailed instructions, refer to the documentation that came with the certificate and to the Sun Microsystems website ([www.sun.com](http://www.sun.com)).

### *Installing a root certificate to the Java Plug-in*

1. Copy the root certificate file from its location on the FTP server to the Java Plug-in bin. For example, the bin location may be:

```
C: \program files\java\j2re1.6.0\bin
```
2. Open a Command Prompt window and change the directory to the Java Plug-in bin.
3. Enter the **keytool** command and respond to the prompts.

**Example of installing a root certificate**

```

C:\Program Files\Java\j2re1.6.0\bin> keytool -import -alias RootCert -file
RootCert.crt -keystore ..\lib\security\RootCerts
Enter keystore password:  changeit
Owner: CN=Brocade, OU=Software, O=Brocade Communications, L=San Jose,
ST=California, C=US
Issuer: CN=Brocade, OU=Software, O=Brocade Communications, L=San Jose,
ST=California, C=US
Serial number: 0
Valid from: Thu Jan 15 16:27:03 PST 2007 until: Sat Feb 14 16:27:03 PST 2007
Certificate fingerprints:
    MD5:  71:E9:27:44:01:30:48:CC:09:4D:11:80:9D:DE:A5:E3
    SHA1: 06:46:C5:A5:C8:6C:93:9C:FE:6A:C0:EC:66:E9:51:C2:DB:E6:4F:A1
Trust this certificate? [no]:  yes
Certificate was added to keystore

```

In the example, **changeit** is the default password and **RootCert** is an example root certificate name.

## Simple Network Management Protocol

The Simple Network Management Protocol (SNMP) is a standard method for monitoring and managing network devices. Using SNMP components, you can program tools to view, browse, and manipulate Brocade switch variables and set up enterprise-level management processes.

Every Brocade switch carries an SNMP agent and management information base (MIB). The agent accesses MIB information about a device and makes it available to a network management station. You can manipulate information of your choice by *trapping* MIB elements using the Fabric OS command line interface (CLI), Web Tools, or Brocade Network Advisor.

The SNMP access control list (ACL) provides a way for the administrator to restrict SNMP get, set, trap, and inform operations to certain hosts and IP addresses. This is used for enhanced management security in the storage area network.

For details on Brocade MIB files, naming conventions, loading instructions, and information about using Brocade's SNMP agent, see the *Fabric OS MIB Reference*.

You can configure SNMPv3 and SNMPv1 for the automatic transmission of SNMP information to management stations.

The configuration process involves configuring the SNMP agent and configuring SNMP traps. Use the **snmpConfig** command to configure the SNMP agent and traps for SNMPv3 or SNMPv1 configurations, and the security level. You can specify no security, authentication only, or authentication and privacy.

The SNMP trap configuration specifies the MIB trap elements to be used to send information to the SNMP management station. There are two main MIB trap choices:

- Brocade-specific MIB trap
 

Associated with the Brocade-specific MIB (SW-MIB), this MIB monitors Brocade switches specifically.
- FibreAlliance MIB trap
 

Associated with the FibreAlliance MIB (FA-MIB), this MIB manages SAN switches and devices from any company that complies with FibreAlliance specifications.

If you use both SW-MIB and FA-MIB, you may receive duplicate information. You can disable the FA-MIB, but not the SW-MIB.

You can also use these additional MIBs and their associated traps:

- FICON-MIB (for FICON environments)
- SW-EXTTRAP  
Includes the swSsn (Software Serial Number) as a part of Brocade SW traps.

For information on Brocade MIBs, see the *Fabric OS MIB Reference*.

For information on the specific commands used in these procedures, refer to the online help or the *Fabric OS Command Reference*.

### SNMP and Virtual Fabrics

When an SNMPv3 request arrives with a particular username, it executes in the home Virtual Fabric. From the SNMP manager all SNMPv3 requests must have a home Virtual Fabric that is specified in the *contextName* field. Whenever the home Virtual Fabric is specified, it will be converted to the corresponding switch ID and the home Virtual Fabric will be set. If the user does not have permission for the specified home Virtual Fabric, this request fails with an error code of *noAccess*.

For an SNMPv3 user to have a home Virtual Fabric, a list of allowed Virtual Fabrics, an RBAC role, and the name of the SNMPv3 user should match that of the Fabric OS user in the local switch database. SNMPv3 users whose names do not match with any of the existing Fabric OS local users have a default RBAC role of admin with the SNMPv3 user access control of read/write. Their SNMPv3 user logs in with an access control of read-only. Both user types will have the default switch as their home Virtual Fabrics.

The *contextName* field should have the format “VF:xxx” where xxx is the actual VF\_ID, for example “VF:1”. If the *contextName* field is empty, then the home Virtual Fabric of the local Fabric OS user with the same name is used. As Virtual Fabrics and Admin Domains are mutually exclusive, this field is considered as Virtual Fabrics context whenever Virtual Fabrics is enabled. You cannot specify chassis context in the *contextName* field.

The following example shows how the VF:xx field is used in the **snmpwalk** command. The **snmpwalk** command is executed on the host and it walks the entire MIB tree specified (.1).

```
#snmpwalk -u admin -v 3 -n VF:4 192.168.176.181 .1
```

#### *Filtering ports*

Each port can belong to only one Virtual Fabric at any time. An SNMP request coming to one Virtual Fabric can only view the port information of the ports belonging to that Virtual Fabric. All port attributes are filtered to allow SNMP to obtain the port information only from within the current Virtual Fabrics context.

#### *Switch and chassis context enforcement*

All attributes are classified into one of two categories:

- Chassis-level attributes
- Switch-level attributes

Attributes that are specific to each logical switch belong to the switch category. These attributes are available in the Virtual Fabrics context and not available in the Chassis context.

Attributes that are common across the logical switches belong to the chassis level. These attributes are accessible to users having the chassis-role permission. When a chassis table is queried the context is set to chassis context, if the user has the chassis-role permission. The context is switched back to the original context after the operation is performed.

## The security level

Use the `snmpConfig --set seclevel` command to set the security level. For more information about using the Brocade SNMP agent, see the *Fabric OS MIB Reference*.

## The snmpConfig command

Use the `snmpConfig --set` command to change either the SNMPv3 or SNMPv1 configuration. You can also change access control, MIB capability, and system group.

For details on Brocade MIB files, naming conventions, loading instructions, and information about using the Brocade SNMP agent, see the *Fabric OS MIB Reference*.

# Telnet protocol

Telnet is enabled by default. To prevent passing clear text passwords over the network when connecting to the switch, you can block the Telnet protocol using an IP Filter policy. For more information on IP Filter policies, refer to “[IP Filter policy](#)” on page 153.

---

### ATTENTION

Before blocking Telnet, make sure you have an alternate method of establishing a connection with the switch.

---

## Blocking Telnet

If you create a new policy using commands with just one rule, all the missing rules have an implicit deny and you lose all IP access to the switch, including Telnet, SSH, and management ports.

1. Connect to the switch and log in using an account with admin permissions.
2. Clone the default policy by typing the `ipFilter --clone` command.

```
switch:admin> ipfilter --clone BlockTelnet -from default_ipv4
```

3. Save the new policy by typing the `ipFilter --save` command.

```
switch:admin> ipfilter --save BlockTelnet
```

4. Verify the new policy exists by typing the `ipFilter --show` command.

```
switch:admin> ipfilter --show
```

5. Add a rule to the policy, by typing the **ipFilter --addrule** command.

```
switch:admin> ipfilter --addrule BlockTelnet -rule 1 -sip any -dp 23 -proto
tcp -act deny
```

---

#### ATTENTION

The rule number assigned has to precede the default rule number for this protocol. For example, in the defined policy, the Telnet rule number is 2, therefore to effectively block Telnet, the rule number to assign must be 1.

If you choose not to use 1, you will need to delete the telnet rule number 2 after adding this rule. Refer to [“Deleting a rule to an IP Filter policy”](#) on page 159 for more information on deleting IP filter rules.

---

6. Save the new ipfilter policy by typing the **ipfilter --save** command.
7. Verify the new policy is correct by typing the **ipFilter --show** command.
8. Activate the new ipfilter policy by typing the **ipfilter --activate** command.

```
switch:admin> ipfilter --activate BlockTelnet
```

9. Verify the new policy is active (the default\_ipv4 policy should be displayed as *defined*).

```
switch:admin> ipfilter --show
Name: BlockTelnet, Type: ipv4, State: defined
Rule      Source IP      Protocol      Dest Port      Action
1        any           tcp         23           deny
2         any            tcp           22             permit
3         any            tcp           22             permit
4         any            tcp           897            permit
5         any            tcp           898            permit
6         any            tcp           111            permit
7         any            tcp           80             permit
8         any            tcp           443            permit
9         any            udp           161            permit
10        any            udp           111            permit
11        any            udp           123            permit
12        any            tcp           600 - 1023     permit
13        any            udp           600 - 1023     permit
```

```
Name: default_ipv4, Type: ipv4, State: defined
Rule      Source IP      Protocol      Dest Port      Action
1         any            tcp           22             permit
2         any            tcp           23             permit
3         any            tcp           897            permit
4         any            tcp           898            permit
5         any            tcp           111            permit
6         any            tcp           80             permit
7         any            tcp           443            permit
8         any            udp           161            permit
9         any            udp           111            permit
10        any            udp           123            permit
11        any            tcp           600 - 1023     permit
12        any            udp           600 - 1023     permit
```

## Unblocking Telnet

1. Connect to the switch through a serial port or SSH and log in as admin.
2. Type in the **ipfilter --delete** command.

Refer to [“Deleting a rule to an IP Filter policy”](#) on page 159 for more information on deleting IP filter rules.

3. To permanently delete the policy, type the **ipfilter --save** command.

---

### ATTENTION

If you deleted the rule to permit Telnet, you will need to add a rule to permit Telnet.

---

## Listener applications

Brocade switches block Linux subsystem listener applications that are not used to implement supported features and capabilities. [Table 22](#) lists the listener applications that Brocade switches either block or do not start.

**TABLE 22** Blocked listener applications

Listener application	Brocade DCX and DCX 8510 Backbone families	Brocade switches
chargen	Disabled	Disabled
echo	Disabled	Disabled
daytime	Disabled	Disabled
discard	Disabled	Disabled
ftp	Disabled	Disabled
rexec	Block with packet filter	Disabled
rsh	Block with packet filter	Disabled
rlogin	Block with packet filter	Disabled
time	Block with packet filter	Disabled
rstats	Disabled	Disabled
rusers	Disabled	Disabled

## Ports and applications used by switches

If you are using the FC-FC Routing Service, be aware that the **secModeEnable** command is not supported.

[Table 23](#) on page 130 lists the defaults for accessing hosts, devices, switches, and zones.

**TABLE 23** Access defaults

Access default	
Hosts	Any host can access the fabric by SNMP.
	Any host can Telnet to any switch in the fabric.
	Any host can establish an HTTP connection to any switch in the fabric.
	Any host can establish an API connection to any switch in the fabric.
Devices	All devices can access the management server.
	Any device can connect to any FC port in the fabric.
Switch access	Any switch can join the fabric.
	All switches in the fabric can be accessed through a serial port.
Zoning	No zoning is enabled.

## Port configuration

Table 24 provides information on ports that the switch uses. When configuring the switch for various policies, take into consideration firewalls and other devices that may sit between switches in the fabric and your network or between the managers and the switch.

**TABLE 24** Port information

Port	Type	Common use	Comment
22	TCP	SSH, SCP	
23	TCP	Telnet	Use the <b>ipfilter</b> command to block the port.
80	TCP	HTTP	Use the <b>ipfilter</b> command to block the port.
111	UDP	sunrpc	This port is used by Platform API. Use the <b>ipfilter</b> command to block the port.
123	UDP	NTP	
161	UDP	SNMP	Disable the SNMP service on the remote host if you do not use it, or filter incoming UDP packets going to this port.
443	TCP	HTTPS	Use the <b>ipfilter</b> command to block the port.
512	TCP	exec	
513	TCP	login	
514	TCP	shell	
897	TCP		This port is used by the Platform API.



# Configuring Security Policies

---

## In this chapter

- [ACL policies overview](#) ..... 131
- [ACL policy management](#) ..... 132
- [FCS policies](#) ..... 135
- [DCC policies](#) ..... 138
- [SCC Policies](#) ..... 142
- [Authentication policy for fabric elements](#) ..... 143
- [IP Filter policy](#) ..... 153
- [Policy database distribution](#) ..... 160
- [Management interface security](#) ..... 166

## ACL policies overview

Each supported Access Control List (ACL) policy listed below is identified by a specific name, and only one policy of each type can exist, except for DCC policies. Policy names are case-sensitive and must be entered in all uppercase. Fabric OS provides the following policies:

- **Fabric configuration server** (FCS) policy — Used to restrict which switches can change the configuration of the fabric.
- **Device connection control** (DCC) policies — Used to restrict which Fibre Channel device ports can connect to which Fibre Channel switch ports.
- **Switch connection control** (SCC) policy — Used to restrict which switches can join with a switch.

---

### NOTE

Run all commands in this chapter by logging in to Administrative Domain (AD) 255 with the suggested permissions. If Administrative Domains have not been implemented, log in to ADO.

---

## How the ACL policies are stored

The policies are stored in a local database. The database contains the ACL policy types of FCS, DCC, SCC, and IPFilter. The number of policies that may be defined is limited by the size of the database. FCS, SCC and DCC policies are all stored in the same database.

In a fabric with Fabric OS v6.2.0 and later switches present, the limit for security policy database size is set to 1Mb. The policies are grouped by state and type. A policy can be in either of the following states:

- **Active**, which means the policy is being enforced by the switch.
- **Defined**, which means the policy has been set up but is not enforced.

Policies with the same state are grouped together in a *Policy Set*. Each switch has the following two sets:

- **Active policy set**, which contains ACL policies being enforced by the switch.
- **Defined policy set**, which contains a copy of all ACL policies on the switch.

When a policy is activated, the defined policy either replaces the policy with the same name in the active set or becomes a new active policy. If a policy appears in the defined set but not in the active set, the policy was saved but has not been activated. If a policy with the same name appears in both the defined and active sets but they have different values, then the policy has been modified but the changes have not been activated.

**Admin Domain considerations:** ACL management can be done on AD255 and in ADO only if there are no user-defined Admin Domains. Both ADO (when no other user-defined Admin Domains exist) and AD255 provide an unfiltered view of the fabric.

**Virtual Fabric considerations:** ACL policies such as DCC, SCC, and FCS can be configured on each logical switch. The limit for security policy database size is set to 1Mb per logical switch.

## Policy members

The FCS, DCC and SCC policy members are specified by device port WWN, switch WWN, domain IDs, or switch names, depending on the policy. The valid methods for specifying policy members are listed in [Table 25](#).

**TABLE 25** Valid methods for specifying policy members

Policy name	Device port WWN or Fabric port WWN	Switch WWN	Domain ID	Switch name
FCS_POLICY	No	Yes	Yes	Yes
DCC_POLICY_nnn	Yes	Yes	Yes	Yes
SCC_POLICY	No	Yes	Yes	Yes

## ACL policy management

All policy modifications are temporarily stored in volatile memory until those changes are saved or activated. You can create multiple sessions to the switch from one or more hosts. It is recommended you make changes from one switch only to prevent multiple transactions from occurring. Each logical switch will have its own access control list.

The FCS, SCC and DCC policies in Secure Fabric OS are not interchangeable with Fabric OS FCS, SCC and DCC policies. Uploading and saving a copy of the Fabric OS configuration after creating policies is strongly recommended. For more information on configuration uploads, see [Chapter 8, “Maintaining the Switch Configuration File”](#).

---

### NOTE

All changes, including the creation of new policies, are saved and activated on the local switch only—unless the switch is in a fabric that has a strict or tolerant fabric-wide consistency policy for the ACL policy type for SCC or DCC. See [“Policy database distribution”](#) on page 160 for more information on the database settings and fabric-wide consistency policy.

---

## Displaying ACL policies

You can view the active and defined policy sets at any time. Additionally, in a defined policy set, policies created in the same login session also appear but these policies are automatically deleted if the you log out without saving them.

1. Connect to the switch and log in using an account with admin permissions, or an account with O permission for the Security RBAC class of commands.
2. Type the **secPolicyShow** command.

```
switch:admin> secPolicyShow
```

---

ACTIVE POLICY SET

---

DEFINED POLICY SET

## Saving changes without activating the policies

1. Connect to the switch and log in using an account with admin permissions, or an account with OM permissions for the Security RBAC class of commands.
2. Enter the **secPolicySave** command.

## Activating policy changes

You can implement changes to the ACL policies using the **secPolicyActivate** command. This saves the changes to the active policy set and activates all policy changes since the last time the command was issued. You cannot activate policies on an individual basis; all changes to the entire policy set are activated by the command. Until a **secPolicySave** or **secPolicyActivate** command is issued, all policy changes are in volatile memory only and are lost upon rebooting.

1. Connect to the switch and log in using an account with admin permissions, or an account with OM permissions for the Security RBAC class of commands.
2. Type the **secPolicyActivate** command.

### Example of activating policy changes

```
switch:admin> secpolicyactivate
About to overwrite the current Active data.
ARE YOU SURE (yes, y, no, n): [no] y
```

## Deleting an ACL policy

1. Connect to the switch and log in using an account with admin permissions, or an account with OM permissions for the Security RBAC class of commands.
2. Type **secPolicyDelete** *“policy\_name”*.  
where *policy\_name* is the name of the ACL policy.
3. Save and activate the policy deletion by entering the **secPolicyActivate** command.

### Example of deleting an ACL policy

```
switch:admin> secpolicydelete "DCC_POLICY_010"  
About to delete policy Finance_Policy.  
Are you sure (yes, y, no, n):[no] y  
Finance_Policy has been deleted.
```

## Adding a member to an existing ACL policy

As soon as a policy has been activated, the aspect of the fabric managed by that policy is enforced.

1. Connect to the switch and log in using an account with admin permissions, or an account with OM permissions for the Security RBAC class of commands.
2. Enter the **secPolicyAdd** command.
3. To implement the change immediately, enter the **secPolicyActivate** command.

### Example of adding to an ACL policy

For example, to add a member to the SCC\_POLICY using the switch WWN:

```
switch:admin> secpolicyadd "SCC_POLICY", "12:24:45:10:0a:67:00:40"  
Member(s) have been added to SCC_POLICY.
```

### Example of adding members to the DCC policy

To add two devices to the DCC policy, and to attach domain 3 ports 1 and 3 (WWNs of devices are 11:22:33:44:55:66:77:aa and 11:22:33:44:55:66:77:bb):

```
switch:admin> secpolicyadd "DCC_POLICY_abc",  
"11:22:33:44:55:66:77:aa;11:22:33:44:55:66:77:bb;3 (1,3) "
```

## Removing a member from an ACL policy

As soon as a policy has been activated, the aspect of the fabric managed by that policy is enforced.

1. Connect to the switch and log in using an account with admin permissions, or an account with OM permissions for the Security RBAC class of commands.
2. Enter the **secPolicyRemove** command.
3. To implement the change immediately, enter the **secPolicyActivate** command.

### Example of removing a member

For example, to remove a member that has a WWN of 12:24:45:10:0a:67:00:40 from the SCC\_POLICY:

```
switch:admin> secpolicyremove "SCC_POLICY", "12:24:45:10:0a:67:00:40"  
Member(s) have been removed from SCC_POLICY.
```

## Aborting unsaved policy changes

You can abort all ACL policy changes that have not yet been saved.

1. Connect to the switch and log in using an account with admin permissions, or an account with OM permissions for the Security RBAC class of commands.
2. Enter the **secPolicyAbort** command.

**Example of aborting unsaved changes**

```
switch:admin> secpolicyabort
Unsaved data has been aborted.
```

All changes since the last time the **secPolicySave** or **secPolicyActivate** commands were entered are aborted.

## FCS policies

Fabric configuration server (FCS) policy in base Fabric OS may be performed on a local switch basis and may be performed on any switch in the fabric.

The FCS policy is not present by default, but must be created. When the FCS policy is created, the WWN of the local switch is automatically included in the FCS list. Additional switches can be included in the FCS list. The first switch in the list becomes the Primary FCS switch.

Switches in the fabric are designated as either a Primary FCS, backup FCS, or non-FCS switch. Only the Primary FCS switch is allowed to modify and distribute the database within the fabric. Automatic distribution is supported and you can either configure the switches in your fabric to accept the FCS policy or manually distribute the FCS policy. Changes made to the FCS policy are saved to permanent memory only after the changes have been saved or activated; they can be aborted later if you have set your fabric to distribute the changes manually.

**TABLE 26** FCS policy states

Policy state	Characteristics
No active policy	Any switch can perform fabric-wide configuration changes.
Active policy with one entry	A Primary FCS switch is designated (local switch), but there are no backup FCS switches. If the Primary FCS switch becomes unavailable for any reason, the fabric is left without an FCS switch.
Active policy with multiple entries	A Primary FCS switch and one or more backup FCS switches are designated. If the Primary FCS switch becomes unavailable, the next switch in the list becomes the Primary FCS switch.

## FCS policy restrictions

The backup FCS switches normally cannot modify the policy. However, if the Primary FCS switch in the policy list is not reachable, then a backup FCS switch is allowed to modify the policy.

Once an FCS policy is configured and distributed across the fabric, only the Primary FCS switch can perform certain operations. Operations that affect fabric-wide configuration are allowed only from the Primary FCS switch. Backup and non-FCS switches cannot perform security, zoning and AD operations that affect the fabric configuration. The following error message is returned if a backup or non-FCS switch tries to perform these operations:

*Can only execute this command on the Primary FCS switch.*

Operations that do not affect the fabric configuration, such as **show** or local switch commands, are allowed on backup and non-FCS switches.

FCS enforcement applies only for user-initiated fabric-wide operations. Internal fabric data propagation because of a fabric merge is not blocked. Consequently, a new switch that joins the FCS-enabled fabric could still propagate the AD and zone database.

Table 27 shows the commands for switch operations for Primary FCS enforcement.

**TABLE 27 FCS switch operations**

Allowed on FCS switches	Allowed on all switches
secPolicyAdd (Allowed on all switches for SCC and DCC policies as long as it is not fabric-wide)	secPolicyShow
secPolicyCreate (Allowed on all switches for SCC and DCC policies as long as it is not fabric-wide)	fddCfg --localaccept or fddCfg --localreject
secPolicyDelete (Allowed on all switches for SCC and DCC policies as long as its not fabric-wide)	userconfig, Passwd, Passwdcfg (Fabric-wide distribution is not allowed from a backup or non-FCS switch.)
secPolicyRemove (Allowed on all switches for SCC and DCC policies as long as its not fabric-wide)	secPolicyActivate
fddCfg --fabwideset	secPolicySave
Any fabric-wide commands	secPolicyAbort
All zoning commands except the show commands	SNMP commands
All AD commands	configupload
	Any local-switch commands
	Any AD command that does not affect fabric-wide configuration

## Ensuring fabric domains share policies

Whether your intention is to create new FCS policies or manage your current FCS policies, you must follow certain steps to ensure the domains throughout your fabric have the same policy.

The local-switch WWN cannot be deleted from the FCS policy.

1. Create the FCS policy using the **secPolicyCreate** command.
2. Activate the policy using the **secPolicyActivate** command.  
If the command is not entered, the changes are lost when the session is logged out.
3. To distribute the policies, enter the **distribute -p policy\_list -d switch\_list** command to either send the policies to intended domains, or enter the **distribute -p policy\_list -d wild\_card (\*)** command to send the policies to all switches.

## Creating an FCS policy

1. Connect to the switch and log in using an account with admin permissions, or an account with OM permissions for the Security RBAC class of commands.
2. Enter the **secPolicyCreate "FCS\_POLICY"** command.

### Example of creating an FCS policy

The following example creates an FCS policy that allows a switch with domain ID 2 to become a primary FCS and domain ID 4 to become a backup FCS:

```
switch:admin> secpolicycreate "FCS_POLICY", "2;4"
FCS_POLICY has been created
```

- To save or activate the new policy, enter either the **secPolicySave** or the **secPolicyActivate** command. Once the policy has been activated you can distribute the policy.

---

**NOTE**

FCS policy must be consistent across the fabric. If the policy is inconsistent in the fabric, then you will not be able to perform any fabric-wide configurations from the primary FCS.

---

## Modifying the order of FCS switches

- Log in to the Primary FCS switch using an account with admin permissions, or an account with OM permissions for the Security RBAC class of commands.
- Type **secPolicyShow “Defined”, “FCS\_POLICY”**.  
This displays the WWNs of the current Primary FCS switch and backup FCS switches.
- Type **secPolicyFCSMove**; then provide the current position of the switch in the list and the desired position at the prompts.

Alternatively, enter **secPolicyFCSMove [From, To]** command. *From* is the current position in the list of the FCS switch and *To* is the desired position in the list for this switch.

### Example of moving an FCS policy

The following example moves a backup FCS switch from position 2 to position 3 in the FCS list, using interactive mode:

```
primaryfcs:admin> secpolicyfcsmove
Pos   Primary WWN                               DId swName.
=====
1     Yes      10:00:00:60:69:10:02:18    1 switch5.
2     No       10:00:00:60:69:00:00:5a    2 switch60.
3     No       10:00:00:60:69:00:00:13    3 switch73.
Please enter position you'd like to move from : (1..3) [1] 2
Please enter position you'd like to move to : (1..3) [1] 3

-----
DEFINED POLICY SET
FCS_POLICY
Pos   Primary WWN                               DId swName
-----
1     Yes      10:00:00:60:69:10:02:18    1 switch5.
2     No       10:00:00:60:69:00:00:13    3 switch73.
3     No       10:00:00:60:69:00:00:5a    2 switch60.
-----
```

- Type the **secPolicyActivate** command to activate and save the new order.

## FCS policy distribution

The FCS policy can be automatically distributed using the **fddCfg --fabwideset** command or it can be manually distributed to the switches using the **distribute -p** command. Each switch that receives the FCS policy must be configured to receive the policy. To configure the switch to accept distribution of the FCS policy, refer to [“Database distribution settings”](#) on page 161.

Database distributions may be initiated from only the Primary FCS switch. FCS policy configuration and management is performed using the command line or a manageability interface.

Only the Primary FCS switch is allowed to distribute the database. The FCS policy may need to be manually distributed across the fabric using the **distribute -p** command. Since this policy is distributed manually, the command **fddCfg --fabwideset** is used to distribute a fabric-wide consistency policy for FCS policy in an environment consisting of only Fabric OS v6.2.0 and later switches.

FCS enforcement for the **distribute** command is handled differently for FCS and other databases in an FCS fabric:

- For an FCS database, the enforcement allows any switch to initiate the distribution. This is to support FCS policy creation specifying a remote switch as Primary.
- For other database distributions, only the Primary FCS switch can initiate the distribution.

The FCS policy distribution is allowed to be distributed from a switch in the FCS list. However, if none of the FCS switches in the existing FCS list are reachable, receiving switches accept distribution from any switch in the fabric. To learn more about how to distribute policies, refer to [“ACL policy distribution to other switches”](#) on page 162.

Local switch configuration parameters are needed to control whether a switch accepts or rejects distributions of FCS policy and whether the switch is allowed to initiate distribution of an FCS policy. A configuration parameter controls whether the distribution of the policy is accepted or rejected on the local switch. Setting the configuration parameter to accept indicates distribution of the policy will be accepted and distribution may be initiated using the **distribute -p** command. Setting the configuration parameter to reject indicates the policy distribution is rejected and the switch may not distribute the policy.

The default value for the distribution configuration parameter is *accept*, which means the switch accepts all database distributions and is able to initiate a distribute operation for all databases.

**TABLE 28** Distribution policy states

Fabric OS	State
v6.2.0 and later configured to accept	Target switch accepts distribution and fabric state change occurs.
v6.2.0 and later configured to reject	Target switch explicitly rejects the distribution and the operation fails. The entire transaction is aborted and no fabric state change occurs.

## DCC policies

Multiple DCC policies can be used to restrict which device ports can connect to which switch ports. The devices can be initiators, targets, or intermediate devices such as SCSI routers and loop hubs. By default, all device ports are allowed to connect to all switch ports; no DCC policies exist until they are created. For information regarding DCC policies and F\_Port trunking, refer to the *Access Gateway Administrator's Guide*.

Each device port can be bound to one or more switch ports; the same device ports and switch ports may be listed in multiple DCC policies. After a switch port is specified in a DCC policy, it permits connections only from designated device ports. Device ports that are not specified in any DCC policies are allowed to connect only to switch ports that are not specified in any DCC policies.

When a DCC violation occurs, the related port is automatically disabled and must be re-enabled using the **portEnable** command.

[Table 29](#) on page 139 shows the possible DCC policy states.



**TABLE 29** DCC policy states

Policy state	Characteristics
No policy	Any device can connect to any switch port in the fabric.
Policy with no entries	Any device can connect to any switch port in the fabric. An empty policy is the same as no policy.
Policy with entries	<p>If a device WWN or Fabric port WWN is specified in a DCC policy, that device is only allowed access to the switch if connected by a switch port listed in the same policy.</p> <p>If a switch port is specified in a DCC policy, it only permits connections from devices that are listed in the policy.</p> <p>Devices with WWNs that are not specified in a DCC policy are allowed to connect to the switch at any switch ports that are not specified in a DCC policy.</p> <p>Switch ports and device WWNs may exist in multiple DCC policies.</p> <p>Proxy devices are always granted full access and can connect to any switch port in the fabric.</p>

**Virtual Fabrics considerations:** The DCC policies that have entries for the ports that are being moved from one logical switch to another will be considered *stale* and will not be enforced. You can choose to keep *stale* policies in the current logical switch or delete the *stale* policies after the port movements. Use the **secPolicyDelete** command to delete stale DCC policies.

## DCC policy restrictions

The following restrictions apply when using DCC policies:

- Some older private-loop HBAs do not respond to port login from the switch and are not enforced by the DCC policy. This does not create a security problem because these HBAs cannot contact any device outside of their immediate loop.
- DCC policies cannot manage or restrict iSCSI connections, that is, an FC Initiator connection from an iSCSI gateway.
- You cannot manage proxy devices with DCC policies. Proxy devices are always granted full access, even if the DCC policy has an entry that restricts or limits access of a proxy device.
- DCC policies are not supported on the CEE ports of the Brocade 8000.

## Creating a DCC policy

DCC policies must follow the naming convention “DCC\_POLICY\_*nnn*,” where *nnn* represents a unique string. The maximum length is 30 characters, including the prefix DCC\_POLICY\_.

Device ports must be specified by port WWN. Switch ports can be identified by the switch WWN, domain ID, or switch name followed by the port or area number. To specify an allowed connection, enter the device port WWN, a semicolon, and the switch port identification.

The following methods of specifying an allowed connection are possible:

- *deviceportWWN;switchWWN* (port or area number)
- *deviceportWWN;domainID* (port or area number)
- *deviceportWWN;switchname* (port or area number)

1. Connect to the switch and log in using an account with admin permissions, or an account with OM permissions for the Security RBAC class of commands.
2. Enter the **secPolicyCreate** “DCC\_POLICY\_*nnn*” command.  
 DCC\_POLICY\_*nnn* is the name of the DCC policy; *nnn* is a string consisting of up to 19 alphanumeric or underscore characters to differentiate it from any other DCC policies.
3. To save or activate the new policy, enter the appropriate command:
  - To save the policy, enter the **secPolicySave** command.
  - To save and activate the policy, enter the **secPolicyActivate** command.

If neither of these commands is entered, the changes are lost when the session is logged out.

### Example of creating DCC policies

To create the DCC policy “DCC\_POLICY\_server” that includes device 11:22:33:44:55:66:77:aa and port 1 and port 3 of switch domain 1:

```
switch:admin> secpolicycreate
"DCC_POLICY_server", "11:22:33:44:55:66:77:aa;1(1,3)"
DCC_POLICY_server has been created
```

To create the DCC policy “DCC\_POLICY\_storage” that includes device port WWN 22:33:44:55:66:77:11:bb, all ports of switch domain 2, and all currently connected devices of switch domain 2:

```
switch:admin> secpolicycreate "DCC_POLICY_storage",
"22:33:44:55:66:77:11:bb;2[*]"
DCC_POLICY_storage has been created
```

To create the DCC policy “DCC\_POLICY\_abc” that includes device 33:44:55:66:77:11:22:cc and ports 1 through 6 and port 9 of switch domain 3:

```
switch:admin> secpolicycreate "DCC_POLICY_abc",
"33:44:55:66:77:11:22:cc;3(1-6,9)"
DCC_POLICY_abc has been created
```

To create the DCC policy “DCC\_POLICY\_example” that includes devices 44:55:66:77:22:33:44:dd and 33:44:55:66:77:11:22:cc, ports 1 through 4 of switch domain 4, and all devices currently connected to ports 1 through 4 of switch domain 4:

```
switch:admin> secpolicycreate "DCC_POLICY_example",
"44:55:66:77:22:33:44:dd;33:44:55:66:77:11:22:cc;4[1-4]"
DCC_POLICY_example has been created
```

### Deleting a DCC policy

1. Connect to the switch and log in using an account with admin permissions, or an account with OM permissions for the Security RBAC class of commands.
2. Enter the **secPolicyDelete** command.

### Example of deleting stale DCC policies

```
switch:admin> secpolicydelete ALL_STALE_DCC_POLICY
About to clear all STALE DCC policies
ARE YOU SURE (yes, y, no, n): [no] y
```

## DCC policy behavior with Fabric-Assigned PWWNs

A DCC policy check is always performed for the physical port WWN of a device when the HBA has established that the device is attempting a normal FLOGI and has both a fabric-assigned port WWN (FA-PWWN) and a physical port WWN.

DCC policies created with FA-PWWNs will result in the disabling of FA-PWWN assigned ports on subsequent FLOGI. It is therefore recommended to create policies with the physical PWWN

DCC policies created with the lock down feature result in DCC policies with FA-PWWNs. It is therefore recommended to avoid using the lock down feature in fabrics that are using FA-PWWNs.

A DCC policy created with a device WWN for a specific port allows the device to log in only on the same port. The same device will not be allowed to log in on a different port. For devices that log in across an AG, the policy should be created with all the NPIV ports, so even if failover occurs the device will be allowed to log in on a different NPIV port.

[Table 30](#) lists the behavior of the DCC policy with FA-PWWNs in the fabric when the DCC policy is created using lockdown support.

**TABLE 30 DCC policy behavior with FA-PWWN when created using lockdown support**

Configuration	WWN seen on DCC policy list	Behavior when DCC policy activates	Behavior on portDisable and portEnable
<ul style="list-style-type: none"> <li>FA-PWWN has logged into the switch</li> <li>DCC policy creation with lock down (uses FA-PWWN).</li> <li>DCC policy activation.</li> </ul>	FA-PWWN	Traffic will not be disrupted. <sup>1</sup>	Ports will be disabled for security violation. <sup>2</sup>
<ul style="list-style-type: none"> <li>DCC policy creation with lockdown (uses physical PWWN).</li> <li>FA-PWWN has logged into the switch</li> <li>DCC policy activation.</li> </ul>	Physical PWWN	Traffic will not be disrupted.	Ports will come up without security issues.
<ul style="list-style-type: none"> <li>DCC policy creation with lockdown (uses physical PWWN)</li> <li>DCC policy activation</li> <li>FA-PWWN has logged into the switch</li> </ul>	Physical PWWN	Traffic will not be disrupted.	Ports will come up without any security issues.

1. Indicates a security concern, because devices that are logged in with FA-PWWNs will not be disabled after activation of DCC policies that are created with FA-PWWNs. This is done to avoid disturbing any existing management.

2. Any disruption in the port will disable the port for a security violation. As the traffic is already disrupted for this port, you must enforce the DCC policy for a physical device WWN; otherwise, the device will not be allowed to login again.

[Table 31](#) shows the behavior of a DCC policy created manually with the physical PWWN of a device. The configurations shown in this table are the recommended configurations when an FA-PWWN is logged into the switch.

**TABLE 31 DCC policy behavior when created manually with PWWN**

Configuration	WWN seen on DCC policy list	Behavior when DCC policy activates	Behavior on portDisable and portEnable
<ul style="list-style-type: none"> <li>FA-PWWN has logged into the switch.</li> <li>DCC policy creation manually with physical PWWN of device.</li> <li>DCC policy activation.</li> </ul>	PWWN	Traffic will not be disrupted.	Ports will come up without security issues.
<ul style="list-style-type: none"> <li>DCC policy creation manually with physical PWWN</li> <li>FA-PWWN has logged into the switch.</li> <li>DCC policy activation.</li> </ul>	PWWN	Traffic will not be disrupted.	Ports will come up without security issues.
<ul style="list-style-type: none"> <li>DCC policy creation manually with physical PWWN,</li> <li>DCC policy activation.</li> <li>FA-PWWN has logged into the switch.</li> </ul>	Physical PWWN	Traffic will not be disrupted.	Ports will come up without any security issues.

## SCC Policies

The switch connection control (SCC) policy is used to restrict which switches can join the fabric. Switches are checked against the policy each time an E\_Port-to-E\_Port connection is made. The policy is named SCC\_POLICY and accepts members listed as WWNs, domain IDs, or switch names. Only one SCC policy can be created.

By default, any switch is allowed to join the fabric; the SCC policy does not exist until it is created. When connecting a Fibre Channel router to a fabric or switch that has an active SCC policy, the front domain of the Fibre Channel router must be included in the SCC policy.

SCC policy states are shown in [Table 32](#).

**TABLE 32 SCC policy states**

Policy state	SCC policy enforcement
No active policy	All switches can connect to the switch with the specified policy.
Active policy that has no members	All neighboring switches are segmented.
Active policy that has members	The neighboring switches not specified in the SCC policy are segmented.

**Virtual Fabrics considerations:** In a logical fabric environment the SCC policy enforcement is not done on the logical ISL. For a logical ISL-based switch, the SCC policy enforcement is considered as the reference and the logical ISL is formed if the SCC enforcement passes on the extended ISL. The following changes:

- A logical switch supports an SCC policy. You can configure and distribute an SCC policy on a logical switch.
- SCC enforcement is performed on a ISL based on the SCC policy present on the logical switch.

For more information on Virtual Fabrics, refer to [Chapter 10, “Managing Virtual Fabrics”](#).

## Creating an SCC policy

1. Connect to the switch and log in using an account with admin permissions, or an account with OM permissions for the Security RBAC class of commands.
2. Enter the **secPolicyCreate "SCC\_POLICY"** command.
3. Save or activate the new policy by entering either the **secPolicySave** or the **secPolicyActivate** command.

If neither of these commands is entered, the changes are lost when the session is logged out.

### Example of creating an SCC policy

For example, to create an SCC policy that allows switches that have domain IDs 2 and 4 to join the fabric:

```
switch:admin> secpolicycreate "SCC_POLICY", "2;4"  
SCC_POLICY has been created  
switch:admin> secpolicysave
```

## Authentication policy for fabric elements

By default, Fabric OS v6.2.0 and later use DH-CHAP or FCAP protocols for authentication. These protocols use shared secrets and digital certificates, based on switch WWN and public key infrastructure (PKI) technology, to authenticate switches. Authentication automatically defaults to FCAP if both switches are configured to accept FCAP protocol in authentication, unless ports are configured for in-flight encryption, in which case authentication defaults to DH-CHAP if both switches are configured to accept the DH-CHAP protocol in authentication. To use FCAP on both switches, PKI certificates have to be installed.

---

### NOTE

The fabric authentication feature is available in base Fabric OS. No license is required.

---

FCAP requires the exchange of certificates between two or more switches to authenticate to each other before they form or join a fabric. Beginning with Fabric OS v7.0.0, these certificates are no longer issued by Brocade, but only by a third-party which is now the root CA for all of the issued certificates. You can use Brocade and third-party certificates between switches that are Fabric OS v6.4.0, but only Brocade-issued certificates (where Brocade is the root CA) for Fabric OS versions earlier than v6.4.0. The certificates must be in PEM (Privacy Enhanced Mail) encoded format for both root and peer certificates. The switch certificates issued from the third-party vendors can be directly issued from the root CA or from an intermediate CA authority.

When you configure DH-CHAP authentication, you also must define a *pair of shared secrets* known to both switches as a *secret key pair*. [Figure 13](#) illustrates how the secrets are configured. A *secret key pair* consists of a local secret and a peer secret. The local secret uniquely identifies the local switch. The peer secret uniquely identifies the entity to which the local switch authenticates. Every switch can share a *secret key pair* with any other switch or host in a fabric.

To use DH-CHAP authentication, a *secret key pair* has to be configured on both switches. For more information on setting up secret key pairs, refer to [“Setting a secret key pair”](#) on page 149.

When configured, the *secret key pair* is used for authentication. Authentication occurs whenever there is a state change for the switch or port. The state change can be due to a switch reboot, a switch or port disable and enable, or the activation of a policy.

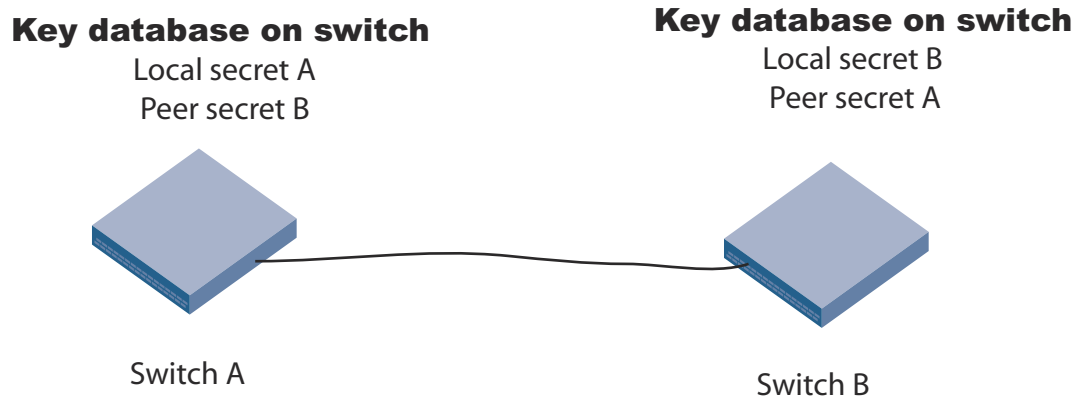

FIGURE 13 DH-CHAP authentication

If you use DH-CHAP authentication, then a *secret key pair* must be installed only in connected fabric elements. However, as connections are changed, new *secret key pairs* must be installed between newly connected elements. Alternatively, a *secret key pair* for all possible connections may be initially installed, enabling links to be arbitrarily changed while still maintaining a valid *secret key pair* for any new connection.

The switch authentication (AUTH) policy initiates DH-CHAP/FCAP authentication on all E\_Ports. This policy is persistent across reboots, which means authentication will be initiated automatically on ports or switches brought online if the policy is set to activate authentication. The AUTH policy is distributed by command; automatic distribution of the AUTH policy is not supported.

The default configuration directs the switch to attempt FCAP authentication first, DH-CHAP second. The switch may be configured to negotiate FCAP, DH-CHAP, or both.

The DH group is used in the DH-CHAP protocol only. The FCAP protocol exchanges the DH group information, but does not use it.

**Virtual Fabrics considerations:** If Virtual Fabrics is enabled, all AUTH module parameters such as shared secrets, and shared switch and device policies, are logical switch-wide. That means you must configure shared secrets and policies separately on each logical switch and the shared secrets and policies must be set on each switch prior to authentication. On logical switch creation, authentication takes default values for policies and other parameters. FCAP certificates are installed on a chassis, but are configured on each logical switch.

## E\_Port authentication

The authentication (AUTH) policy allows you to configure DH-CHAP authentication on switches with Fabric OS v5.3.0 and later. By default the policy is set to PASSIVE and you can change the policy. All changes to the AUTH policy take effect during the next authentication request. This includes starting authentication on all E\_Ports on the local switch if the policy is changed to ON or ACTIVE, and clearing the authentication if the policy is changed to OFF. The authentication configurations will be effective only on subsequent E\_ and F\_Port initialization.

---

### ATTENTION

A *secret key pair* has to be installed prior to changing the policy. For more information on setting up secret key pairs, refer to [“Setting a secret key pair”](#) on page 149.

---

**Virtual Fabrics considerations:** The switch authentication policy applies to all E\_Ports in a logical switch. This includes ISLs and extended ISLs. Authentication of extended ISLs between two base switches is considered peer-chassis authentication. Authentication between two physical entities is required, so the extended ISL which connects the two chassis needs to be authenticated. The corresponding extended ISL for a logical ISL authenticates the peer-chassis, therefore the logical ISL authentication is not required. Because the logical ISLs do not carry actual traffic, they do not need to be authenticated. Authentication on re-individualization is also blocked on logical ISLs. The following error message is printed on the console when you execute the `authUtil --authinit` command on logical-ISLs, “Failed to initiate authentication. Authentication is not supported on logical ports <port#>”. For more information on Virtual Fabrics, refer to [Chapter 10, “Managing Virtual Fabrics”](#).

### *Configuring E\_Port authentication*

1. Connect to the switch and log in using an account with admin permissions, or an account with OM permissions for the Authentication RBAC class of commands.
2. Enter the `authUtil` command to set the switch policy mode.

#### **Example of configuring E\_Port authentication**

The following example shows how to enable Virtual Fabrics and configure the E\_Ports to perform authentication using the AUTH policies `authUtil` command.

```
switch:admin> fosconfig -enable vf
WARNING: This is a disruptive operation that requires a reboot to take
effect.
All EX ports will be disabled upon reboot.
Would you like to continue [Y/N] y

switch:admin> authutil --authinit 2,3,4
```



#### **CAUTION**

If data input has not been completed and a failover occurs, the command is terminated without completion and your entire input is lost.

If data input has completed, the enter key pressed, and a failover occurs, data may or may not be replicated to the other CP depending on the timing of the failover. Log in to the other CP after the failover is complete and verify the data was saved. If data was not saved, run the command again.

#### **Example of setting the policy to active mode**

```
switch:admin> authutil --policy -sw active
Warning: Activating the authentication policy requires
either DH-CHAP secrets or PKI certificates depending
on the protocol selected. Otherwise, ISLs will be
segmented during next E-port bring-up.
ARE YOU SURE (yes, y, no, n): [no] y
Auth Policy is set to ACTIVE
```

### *Re-authenticating E\_Ports*

Use the **authUtil --authinit** command to re-initiate the authentication on selected ports. It provides flexibility to initiate authentication for specified E\_Ports, a set of E\_Ports, or all E\_Ports on the switch. This command does not work on loop, NPIV and FICON devices, or on ports configured for in-flight encryption. The command **authUtil** can re-initiate authentication only if the device was previously authenticated. If the authentication fails because shared secrets do not match, the port is disabled.

This command works independently of the authentication policy; this means you can initiate the authentication even if the switch is in PASSIVE mode. This command is used to restart authentication after changing the DH-CHAP group, hash type, or shared secret between a pair of switches.

---

#### ATTENTION

This command may bring down E\_Ports if the DH-CHAP shared secrets are not installed correctly.

---

1. Log in to the switch using an account with admin permissions, or an account with OM permissions for the Authentication RBAC class of commands.
2. Enter the **authUtil --authinit** command.

#### Example for specific ports on the switch

```
switch:admin> authutil --authinit 2,3,4
```

#### Example for all E\_Ports on the switch

```
switch:admin> authutil --authinit allE
```

#### Example for Backbones using the slot/port format

```
switch:admin> authutil --authinit 1/1, 1/2
```

## Device authentication policy

Device authentication policy can also be categorized as an F\_Port, node port, or an HBA authentication policy. Fabric-wide distribution of the device authentication policy is not supported because the device authentication requires manual interaction in setting the HBA shared secrets and switch shared secrets, and most of the HBAs do not support the defined DH groups for use in the DH-CHAP protocol.

By default the switch is in the OFF state, which means the switch clears the security bit in the FLOGI (fabric login). The **authUtil** command provides an option to change the device policy mode to select PASSIVE policy, which means the switch responds to authentication from any device and does not initiate authentication to devices. When the policy is set to ON, the switch expects a FLOGI with the FC-SP bit set. If not, the switch rejects the FLOGI with reason LS\_LOGICAL\_ERROR (0x03), explanation "Authentication Required"(0x48), and disables the port. Regardless of the policy, the F\_Port is disabled if the DH-CHAP protocol fails to authenticate. If the HBA sets the FC-SP bit during FLOGI and the switch sends a FLOGI accept with the FC-SP bit set, then the switch expects the HBA to start the AUTH\_NEGOTIATE. From this point on until the AUTH\_NEGOTIATE is completed, all ELS and CT frames, except the AUTH\_NEGOTIATE ELS frame, are blocked by the switch. During this time, the Fibre Channel driver rejects all other ELS frames. The F\_Port does not form until the AUTH\_NEGOTIATE is completed. It is the HBA's responsibility to send an Authentication Negotiation ELS frame after receiving the FLOGI accept frame with the FC-SP bit set.



**Virtual Fabrics considerations:** Because the device authentication policy has switch and logical switch-based parameters, each logical switch is set when Virtual Fabrics is enabled. Authentication is enforced based on each logical switch's policy settings.

### *Configuring device authentication*

1. Connect to the switch and log in using an account with admin permissions, or an account with OM permissions for the Authentication RBAC class of commands.
2. Enter the **authUtil** command to set the device policy mode.

#### **Example of setting the Device policy to passive mode:**

```
switch:admin> authutil --policy -dev passive
Warning: Activating the authentication policy requires
DH-CHAP secrets on both switch and device. Otherwise,
the F-port will be disabled during next F-port
bring-up.
ARE YOU SURE (yes, y, no, n): [no] y
Device authentication is set to PASSIVE
```

## **AUTH policy restrictions**

All fabric element authentication configurations are performed on a local switch basis.

Device authentication policy supports devices that are connected to the switch in point-to-point manner and is visible to the entire fabric. The following are not supported:

- Public loop devices
- Single private devices
- Private loop devices
- Mixed public and private devices in loop
- NPIV devices
- FICON channels
- Configupload and download will not be supported for the following AUTH attributes: auth type, hash type, group type.

### *Supported adapters*

The following adapters support authentication:

- Emulex LP11000 (Tested with Storport Miniport v2.0 windows driver)
- Qlogic QLA2300 (Tested with Solaris v5.04 driver)
- Brocade Fibre Channel HBA models 415, 425, 815 and 825
- Brocade HBAs BR-1741M-k, BR-1020, and BR-1007
- BR-1860 Fabric Adapter

## Authentication protocols

Use the **authUtil** command to perform the following tasks:

- Display the current authentication parameters.
- Select the authentication protocol used between switches.
- Select the DH (Diffie-Hellman) group for a switch.

Run the **authUtil** command on the switch you want to view or change. Below are the different options to specify which DH group you want to use.

- 00 – DH Null option
- 01 – 1024 bit key
- 02 – 1280 bit key
- 03 – 1536 bit key
- 04 – 2048 bit key

### *Viewing the current authentication parameter settings for a switch*

1. Log in to the switch using an account with admin permissions, or an account with the O permission for the Authentication RBAC class of commands.
2. Enter the **authUtil --show**.

**Example of output from the authUtil --show command**

```

AUTH TYPE          HASH TYPE          GROUP TYPE
-----
fcap,dhchap        sha1,md5           0, 1, 2, 3, 4

Switch Authentication Policy: PASSIVE
Device Authentication Policy: OFF

```

### *Setting the authentication protocol*

1. Log in to the switch using an account with admin permissions, or an account with OM permissions for the Authentication RBAC class of commands.
2. Enter the **authUtil --set -a** command specifying **fcap**, **dhchap**, or **all**.

**Example of setting the DH-CHAP authentication protocol**

```

switch:admin> authutil --set -a dhchap
Authentication is set to dhchap.

```

When using DH-CHAP, make sure that you configure the switches at both ends of a link.

---

#### **NOTE**

If you set the authentication protocol to DH-CHAP or FCAP, have not configured shared secrets or certificates, and authentication is checked (for example, you enable the switch), then switch authentication fails.

If the E\_Port is to carry in-flight encrypted traffic, the authentication protocol must be set to DH-CHAP. You must also use the **-g** option to set the DH group value to group 4 or all groups. See [Chapter 14, "In-flight Encryption and Compression,"](#) for details about in-flight encryption.

---

## Secret key pairs for DH-CHAP

When you configure the switches at both ends of a link to use DH-CHAP for authentication, you must also define a *secret key pair*—one for each end of the link. Use the **secAuthSecret** command to perform the following tasks:

- View the WWN of switches with a *secret key pair*.
- Set the *secret key pair* for switches.
- Remove the *secret key pair* for one or more switches.

Note the following characteristics of a *secret key pair*:

- The *secret key pair* must be set up locally on every switch. The *secret key pair* is not distributed fabric-wide.
- If a *secret key pair* is not set up for a link, authentication fails. The “Authentication Failed” (reason code 05h) error will be reported and logged.
- The minimum length of a shared secret is 8 characters and the maximum length is 40 characters. If the E\_Port is to carry in-flight encrypted traffic, a shared secret or at least 32 characters is recommended. See [Chapter 14, “In-flight Encryption and Compression”](#) for details about in-flight encryption.

---

### NOTE

When setting a *secret key pair*, note that you are entering the shared secrets in plain text. Use a secure channel (for example, SSH or the serial console) to connect to the switch on which you are setting the secrets.

---

### *Viewing the list of secret key pairs in the current switch database*

1. Log in to the switch using an account with admin permissions, or an account with the O permission for the Authentication RBAC class of commands.
2. Enter the **secAuthSecret --show** command.

The output displays the WWN, domain ID, and name (if known) of the switches with defined shared secrets:

WWN	DId	Name
10:00:00:60:69:80:07:52		Unknown
10:00:00:60:69:80:07:5c	1	switchA

### *Setting a secret key pair*

1. Log in to the switch using an account with admin permissions, or an account with OM permissions for the Authentication RBAC class of commands.
2. Enter the **secAuthSecret --set** command.

The command enters interactive mode. The command returns a description of itself and needed input; then it loops through a sequence of switch specification, peer secret entry, and local secret entry.

To exit the loop, press **Enter** for the switch name; then type **y**.

## Example of setting a secret key pair

```
switchA:admin> secauthsecret --set
```

This command is used to set up secret keys for the DH-CHAP authentication. The minimum length of a secret key is 8 characters and maximum 40 characters. Setting up secret keys does not initiate DH-CHAP authentication. If switch is configured to do DH-CHAP, it is performed whenever a port or a switch is enabled.

Warning: Please use a secure channel for setting secrets. Using an insecure channel is not safe and may compromise secrets.

Following inputs should be specified for each entry.

1. WWN for which secret is being set up.
2. Peer secret: The secret of the peer that authenticates to peer.
3. Local secret: The local secret that authenticates peer.

Press Enter to start setting up shared secrets > **<cr>**

Enter WWN, Domain, or switch name (Leave blank when done):  
**10:20:30:40:50:60:70:80**

Enter peer secret: **<hidden>**  
Re-enter peer secret: **<hidden>**  
Enter local secret: **<hidden>**  
Re-enter local secret: **<hidden>**

Enter WWN, Domain, or switch name (Leave blank when done):  
**10:20:30:40:50:60:70:81**

Enter peer secret: **<hidden>**  
Re-enter peer secret: **<hidden>**  
Enter local secret: **<hidden>**  
Re-enter local secret: **<hidden>**

Enter WWN, Domain, or switch name (Leave blank when done): **<cr>**  
Are you done? (yes, y, no, n): [no] **y**

Saving data to key store.. Done.

3. Disable and enable the ports on a peer switch using the **portDisable** and **portEnable** commands.

## FCAP configuration overview

Beginning with Fabric OS release 7.0.0, you must configure the switch to use third-party certificates for authentication with the peer switch.

To perform authentication with FCAP protocol with certificates issued from third party, the user has to perform following steps:

1. Choose a certificate authority (CA).
2. Generate a public, private key, passphrase and a CSR on each switch.
3. Store the CSR from each switch on a file server.
4. Obtain the certificates from the CA.

You can request a certificate from a CA through a Web browser. After you request a certificate, the CA either sends certificate files by e-mail (public) or gives access to them on a remote host (private). Typically, the CA provides the certificate files listed in [Table 33](#).

---

**ATTENTION**

Only the .pem file is supported for FCAP authentication.

---

**TABLE 33 FCAP certificate files**

Certificate file	Description
<i>nameCA.pem</i>	The CA certificate. It must be installed on the remote and local switch to verify the validity of the switch certificate or switch validation fails.
<i>name.pem</i>	The switch certificate.

5. On each switch, install the CA certificate before installing switch certificate.
6. After the CA certificate is installed, install the switch certificate on each switch.
7. Update the switch database for peer switches to use third-party certificates.
8. Use the newly installed certificates by starting the authentication process.

### *Generating the key and CSR for FCAP*

The public/private key and CSR has to be generated for the local and remote switches that will participate in the authentication. In FCAP, one command is used to generate the public/private key the CSR, and the passphrase.

1. Log in to the switch using an account with admin permissions, or an account associated with the chassis role and having OM permissions for the PKI RBAC class of commands.
2. Enter the **secCertUtil generate -fcapall -keysize** command on the local switch.

```
switch:admin> seccertutil generate -fcapall -keysize 1024
WARNING!!!
```

```
About to create FCAP:
ARE YOU SURE (yes, y, no, n): [no] y
Installing Private Key and Csr...
Switch key pair and CSR generated...
```

3. Repeat [step 2](#) on the remote switch.

### *Exporting the CSR for FCAP*

You will need to export the CSR file created in “[Generating the key and CSR for FCAP](#)” section and send to a Certificate Authority (CA). The CA will in turn provide two files as outlined in “[FCAP configuration overview](#)” on page 150.

1. Log in to the switch using an account with admin permissions, or an account associated with the chassis role and having OM permissions for the PKI RBAC class of commands.
2. Enter the **secCertUtil export -fcapswcsr** command.

```
switch:admin> seccertutil export -fcapswcsr
Select protocol [ftp or scp]: scp
Enter IP address: 10.1.2.3
Enter remote directory: /myHome/jdoe/OPENSSL
```

```
Enter Login Name: jdoe
jdoe@10.1.2.3's password: <hidden text>
Success: exported FCAP CA certificate
```

### *Importing CA for FCAP*

Once you receive the files back from the Certificate Authority, you will need to install or import them onto the local and remote switches.

1. Log in to the switch using an account with admin permissions, or an account associated with the chassis role and having OM permissions for the PKI RBAC class of commands.
2. Enter the **secCertUtil import -fcapswcert** command and verify the CA certificates are consistent on both local and remote switches.

```
switch:admin> seccertutil import -fcapcacert
Select protocol [ftp or scp]: scp
Enter IP address: 10.1.2.3
Enter remote directory: /myHome/jdoe/OPENSSL
Enter certificate name (must have a ".pem" suffix):CACert.pem
Enter Login Name: jdoe
jdoe@10.1.2.3's password: <hidden text>
Success: imported certificate [CACert.pem].
```

### *Importing the FCAP switch certificate*

---

#### **ATTENTION**

The CA certificates must be installed prior to installing the switch certificate.

---

1. Log in to the switch using an account with admin permissions, or an account associated with the chassis role and having OM permissions for the PKI RBAC class of commands.
2. Enter the **secCertUtil import -fcapswcert** command.

```
switch:admin> seccertutil import -fcapswcert
Select protocol [ftp or scp]: scp
Enter IP address: 10.1.2.3
Enter remote directory: /myHome/jdoe/OPENSSL
Enter certificate name (must have ".crt" or ".cer" ".pem" or ".psk"
suffix):01.pem
Enter Login Name: jdoe
jdoe@10.1.2.3's password: <hidden text>
Success: imported certificate [01.pem].
```

### *Starting FCAP authentication*

1. Log in to the switch using an account with admin permissions, or an account with OM permissions for the Authentication RBAC class of commands.
2. Enter the **authUtil --authinit** command to start the authentication using the newly imported certificates.
3. Enter the **authUtil --policy -sw** command and select **active** or **on**, the default is passive. This makes the changes permanent and forces the switch to request authentication.

## Fabric-wide distribution of the Auth policy

The AUTH policy can be manually distributed to the fabric by command; there is no support for automatic distribution. To distribute the AUTH policy, see [“Distributing the local ACL policies”](#) on page 162 for instructions.

Local Switch configuration parameters are needed to control whether a switch accepts or rejects distributions of the AUTH policy using the distribute command and whether the switch may initiate distribution of the policy. To set the local switch configuration parameter, refer to [“Policy database distribution”](#) on page 160.

## IP Filter policy

The IP Filter policy is a set of rules applied to the IP management interfaces as a packet filtering firewall. The firewall permits or denies the traffic to go through the IP management interfaces according to the policy rules.

Fabric OS supports multiple IP Filter policies to be defined at the same time. Each IP Filter policy is identified by a name and has an associated type. Two IP Filter policy types, IPv4 and IPv6, exist to provide separate packet filtering for IPv4 and IPv6. It is not allowed to specify an IPv6 address in the IPv4 filter, or specify an IPv4 address in the IPv6 filter. There can be up to six different IP Filter policies defined for both types. Only one IP Filter policy for each IP type can be activated on the affected management IP interfaces.

Audit messages will be generated for any changes to the IP Filter policies.

The rules in the IP Filter policy are examined one at a time until the end of the list of rules. For performance reasons, the most commonly used rules should be specified at the top.

On a chassis system, changes to persistent IP Filter policies are automatically synchronized to the standby CP when the changes are saved persistently on the active CP. The standby CP will enforce the filter policies to its management interface after policies are synchronized with the active CP.

**Virtual Fabrics considerations:** Each logical switch cannot have its own different IP Filter policies. IP Filter policies are treated as a chassis-wide configuration and are common for all the logical switches in the chassis.

## Creating an IP Filter policy

You can create an IP Filter policy specifying any name and using type IPv4 or IPv6. The policy created is stored in a temporary buffer, and is lost if the current command session logs out. The policy name is a unique string composed of a maximum of 20 alpha, numeric, and underscore characters. The names *default\_ipv4* and *default\_ipv6* are reserved for default IP filter policies. The policy name is case-insensitive and always stored as lowercase. The policy type identifies the policy as an IPv4 or IPv6 filter. There can be a maximum of six IP Filter policies.

1. Log in to the switch using an account with admin permissions, or an account associated with the chassis role and having OM permissions for the IPfilter RBAC class of commands.
2. Enter in the `ipFilter--create` command.

## Cloning an IP Filter policy

You can create an IP Filter policy as an exact copy of an existing policy. The policy created is stored in a temporary buffer and has the same type and rules as the existing defined or active policy.

1. Log in to the switch using an account with admin permissions, or an account associated with the chassis role and having OM permissions for the IPfilter RBAC class of commands.
2. Enter the `ipFilter --clone` command.

## Displaying an IP Filter policy

You can display the IP Filter policy content for the specified policy name, or all IP Filter policies if a policy name is not specified.

For each IP Filter policy, the policy name, type, persistent state and policy rules are displayed. The policy rules are listed by the rule number in ascending order. There is no pagination stop for multiple screens of information. Pipe the output to the `|more` command to achieve this.

If a temporary buffer exists for an IP Filter policy, the `--show` subcommand displays the content in the temporary buffer, with the persistent state set to no.

1. Log in to the switch using an account with admin permissions, or an account associated with the chassis role and having the O permission for the IPfilter RBAC class of commands.
2. Enter the `ipFilter --show` command.

## Saving an IP Filter policy

You can save one or all IP Filter policies persistently in the defined configuration. The policy name is optional for this subcommand. If the policy name is given, the IP Filter policy in the temporary buffer is saved; if the policy name is not given, all IP Filter policies in the temporary buffer are saved. Only the CLI session that owns the updated temporary buffer may run this command. Modification to an active policy cannot be saved without being applied. Hence, the `--save` subcommand is blocked for the active policies. Use `--activate` instead.

1. Log in to the switch using an account with admin permissions, or an account associated with the chassis role and having the OM permissions for the IPfilter RBAC class of commands.
2. Enter the `ipFilter --save` command.

## Activating an IP Filter policy

IP Filter policies are not enforced until they are activated. Only one IP Filter policy per IPv4 and IPv6 type can be active. If there is a temporary buffer for the policy, the policy is saved to the defined configuration and activated at the same time. If there is no temporary buffer for the policy, the policy existing in the defined configuration becomes active. The activated policy continues to remain in the defined configuration. The policy to be activated replaces the existing active policy of the same type. Activating the default IP Filter policies returns the IP management interface to its default state. An IP Filter policy without any rule cannot be activated. This subcommand prompts for a user confirmation before proceeding.



1. Log in to the switch using an account with admin permissions, or an account associated with the chassis role and having OM permissions for the IPfilter RBAC class of commands.
2. Enter the `ipFilter --activate` command.

## Deleting an IP Filter policy

You can delete a specified IP Filter policy. Deleting an IP Filter policy removes it from the temporary buffer. To permanently delete the policy from the persistent database, run `ipfilter --save`. An active IP Filter policy cannot be deleted.

1. Log in to the switch using an account with admin permissions, or an account associated with the chassis role and having the OM permissions for the IPfilter RBAC class of commands.
2. Enter the `ipFilter --delete` command.
3. To permanently delete the policy, enter the `ipfilter --save` command.

## IP Filter policy rules

An IP Filter policy consists of a set of rules. Each rule has an index number identifying the rule. There can be a maximum of 256 rules within an IP Filter policy.

Each rule contains the following elements:

- Source Address: A source IP address or a group prefix.
- Destination Port: The destination port number or name, such as: Telnet, SSH, HTTP, HTTPS.
- Protocol: The protocol type. Supported types are TCP or UDP.
- Action: The filtering action taken by this rule, either Permit or Deny.

A rule type and destination IP can also be specified

### *Source address*

For an IPv4 filter policy, the source address has to be a 32-bit IPv4 address in dot decimal notation. The group prefix has to be a CIDR block prefix representation. For example, 208.130.32.0/24 represents a 24-bit IPv4 prefix starting from the most significant bit. The special prefix 0.0.0.0/0 matches any IPv4 address. In addition, the keyword *any* is supported to represent any IPv4 address.

For an IPv6 filter policy, the source address has to be a 128-bit IPv6 address, in a format acceptable in RFC 3513. The group prefix has to be a CIDR block prefix representation. For example, 12AB:0:0:CD30::/64 represents a 64-bit IPv6 prefix starting from the most significant bit. In addition, the keyword *any* is supported to represent any IPv6 address.

### *Destination port*

For the destination port, a single port number or a port number range can be specified. According to IANA (<http://www.iana.org>), ports 0 to 1023 are well-known port numbers, ports 1024 to 49151 are registered port numbers, and ports 49152 to 65535 are dynamic or private port numbers. Well-known and registered ports are normally used by servers to accept connections, while dynamic port numbers are used by clients.

For an IP Filter policy rule, you can only select port numbers in the well-known port number range, between 0 and 1023, inclusive. This means that you have the ability to control how to expose the management services hosted on a switch, but not the ability to affect the management traffic that is initiated from a switch. A valid port number range is represented by a dash, for example 7-30. Alternatively, service names can also be used instead of port number. [Table 34](#) lists the supported service names and their corresponding port numbers.

**TABLE 34** Supported services

Service name	Port number
echo	7
discard	9
systat	11
daytime	13
netstat	15
chargen	19
ftp data	20
ftp	21
fsp	21
ssh	22
telnet	23
smtp	25
time	27
name	42
whois	43
domain	53
bootps	67
bootpc	68
tftp	69
http	80
kerberos	88
hostnames	101
sunrpc	111
sftp	115
ntp	123
snmp	161
snmp trap	162
https	443
ssmtp	465
exec	512
login	513

**TABLE 34** Supported services (Continued)

Service name	Port number
shell	514
uucp	540
biff	512
who	513
syslog	514
route	520
timed	525
kerberos4	750
rpcd	897
securerpcd	898

### *Protocol*

TCP and UDP protocols are valid protocol selections. Fabric OS v6.2.0 and later do not support configuration to filter other protocols. Implicitly, ICMP type 0 and type 8 packets are always allowed to support ICMP echo request and reply on commands like ping and traceroute.

### *Action*

For the action, only “permit” and “deny” are valid.

### *Traffic type and destination IP*

The traffic type and destination IP elements allow an IP policy rule to specify filter enforcement for IP forwarding. The INPUT traffic type is the default and restricts rules to manage traffic on IP management interfaces,

The FORWARD traffic type allows management of bidirectional traffic between the external management interface and the inband management interface. In this case, the destination IP element should also be specified.

### *Implicit filter rules*

For every IP Filter policy, the two rules listed in [Table 35](#) are always assumed to be appended implicitly to the end of the policy. This ensures that TCP and UDP traffic to dynamic port ranges is allowed, so that management IP traffic initiated from a switch, such as syslog, radius and ftp, is not affected.

**TABLE 35** Implicit IP Filter rules

Source address	Destination port	Protocol	Action
Any	1024-65535	TCP	Permit
Any	1024-65535	UDP	Permit

### *Default policy rules*

A switch with Fabric OS v6.2.0 or later will have a default IP Filter policy for IPv4 and IPv6. The default IP Filter policy cannot be deleted or changed. When an alternative IP Filter policy is activated, the default IP Filter policy becomes deactivated. [Table 36](#) lists the rules of the default IP Filter policy.

**TABLE 36** Default IP policy rules

Rule number	Source address	Destination port	Protocol	Action
1	Any	22	TCP	Permit
2	Any	23	TCP	Permit
3	Any	897	TCP	Permit
4	Any	898	TCP	Permit
5	Any	111	TCP	Permit
6	Any	80	TCP	Permit
7	Any	443	TCP	Permit
8	Any	161	UDP	Permit
9	Any	111	UDP	Permit
10	Any	123	UDP	Permit
11	Any	600-1023	TCP	Permit
12	Any	600-1023	UDP	Permit

## IP Filter policy enforcement

An active IP Filter policy is a filter applied to the IP packets through the management interface. IPv4 management traffic passes through the active IPv4 filter policy, and IPv6 management traffic passes through the active IPv6 filter policy. The IP Filter policy applies to the incoming (ingress) management traffic only. When a packet arrives, it is compared against each rule, starting from the first rule. If a match is found for the source address, destination port, and protocol, the corresponding action for this rule is taken, and the subsequent rules in this policy are ignored. If there is no match, then it is compared to the next rule in the policy. This process continues until the incoming packet is compared to all rules in the active policy.

If none of the rules in the policy matches the incoming packet, the two implicit rules are matched to the incoming packet. If the rules still do not match the packet, the default action, which is to deny, is taken.

When the IPv4 or IPv6 address for the management interface of a switch is changed through the **ipAddrSet** command or manageability tools, the active IP Filter policies automatically become enforced on the management IP interface with the changed IP address.

### NOTE

If a switch is part of a LAN behind a Network Address Translation (NAT) server, depending on the NAT server configuration, the source address in an IP Filter rule may have to be the NAT server address.

## Adding a rule to an IP Filter policy

There can be a maximum of 256 rules created for an IP Filter policy. The change to the specified IP Filter policy is not saved to the persistent configuration until a `save` or `activate` subcommand is run.

1. Log in to the switch using an account with admin permissions, or an account associated with the chassis role and having the OM permissions for the IPfilter RBAC class of commands.
2. Enter the `ipFilter --addrule` command.

## Deleting a rule to an IP Filter policy

Deleting a rule in the specified IP Filter policy causes the rules following the deleted rule to shift up in rule order. The change to the specified IP Filter policy is not saved to persistent configuration until a `save` or `activate` subcommand is run.

1. Log in to the switch using an account with admin permissions, or an account associated with the chassis role and having the OM permissions for the IPfilter RBAC class of commands.
2. Enter the `ipFilter --delrule` command.

## Aborting an IP Filter transaction

A transaction is associated with a command line or manageability session. It is opened implicitly when the `--create`, `--addrule`, `--delrule`, `--clone`, and `--delete` subcommands are run. The `--transabort`, `--save`, or `--activate` subcommands explicitly end the transaction owned by the current command line or manageability session. If a transaction is not ended, other command line or manageability sessions are blocked on the subcommands that would open a new transaction.

1. Log in to the switch using an account with admin permissions, or an account associated with the chassis role and having the OM permissions for the IPfilter RBAC class of commands.
2. Enter the `ipFilter --transabort` command.

## IP Filter policy distribution

The IP Filter policy is manually distributed by command. The distribution includes both active and defined IP Filter policies. All policies are combined as a single entity to be distributed and cannot be selectively distributed. However, you may choose the time at which to implement the policy for optimization purposes. If a distribution includes an active IP Filter policy, the receiving switches activate the same IP Filter policy automatically. When a switch receives IP Filter policies, all uncommitted changes left in its local transaction buffer are lost, and the transaction is aborted.

The IPFilter policy can be manually distributed to the fabric by command; there is no support for automatic distribution. To distribute the IPFilter policy, see [“Distributing the local ACL policies”](#) on page 162 for instructions.

Switches with Fabric OS v6.2.0 or later have the ability to accept or deny IP Filter policy distribution, through the commands `fddCfg --localaccept` or `fddCfg --localreject`. See [“Policy database distribution”](#) on page 160 for more information on distributing the IP Filter policy.

**Virtual Fabrics considerations:** To distribute the IPFilter policy in a logical fabric, use the `chassisDistribute` command.

## Managing filter thresholds

Fabric OS v7.0.0 allows you to configure filter thresholds using the **fmMonitor** command.

1. Connect to the switch and log in using an account with admin permissions, or an account with OM permissions for the FabricWatch RBAC class of commands.
2. Enter the **fmMonitor** command.

**Example of fmMonitor command:**

```
admin> fmMonitor --create ex1 -pat 12,0xFF,0x08 -port 2/1-2,8/3 -highth
1000 - action snmp,raslog -timebase minute
```

## Policy database distribution

Fabric OS lets you manage and enforce the ACL policy database on either a per-switch or fabric-wide basis. The local switch distribution setting and the fabric-wide consistency policy affect the switch ACL policy database and related distribution behavior.

The ACL policy database is managed as follows:

- **Switch database distribution setting** — Controls whether or not the switch accepts or rejects databases distributed from other switches in the fabric. The **distribute** command sends the database from one switch to another, overwriting the target switch database with the distributed one. To send or receive a database the setting must be accept. For configuration instructions, see [“Database distribution settings”](#) on page 161.

Virtual Fabric considerations: FCS, DCC, SCC, and AUTH databases can be distributed using the **-distribute** command, but the PWD and IPFILTER databases are blocked from distribution.

- **Manually distribute an ACL policy database** — Run the **distribute** command to push the local database of the specified policy type to target switches. [“ACL policy distribution to other switches”](#) on page 162.
- **Fabric-wide consistency policy** — Use to ensure that switches in the fabric enforce the same policies. Set a strict or tolerant fabric-wide consistency policy for each ACL policy type to automatically distribute that database when a policy change is activated. If a fabric-wide consistency policy is not set, then the policies are managed on a per switch basis. For configuration instructions, see [“Fabric-wide enforcement”](#) on page 163.

**Virtual Fabric considerations:** Fabric-wide consistency policies are configured on a per logical switch-basis and are applied to the fabrics connected to the logical switches. Automatic policy distribution behavior for DCC, SCC and FCS is the same as that of pre-v6.2.0 releases and are configured on a per logical switch basis.

[Table 37](#) on page 161 explains how the local database distribution settings and the fabric-wide consistency policy affect the local database when the switch is the target of a distribution command.

**TABLE 37** Interaction between fabric-wide consistency policy and distribution settings

Distribution setting	Fabric-wide consistency policy		
	Absent (default)	Tolerant	Strict
Reject	Database is protected, it cannot be overwritten. May not match other databases in the fabric.	Invalid configuration. <sup>1</sup>	Invalid configuration. <sup>1</sup>
Accept (default)	Database is not protected, the database can be overwritten. If the switch initiating a distribute command has a strict or tolerant fabric-wide consistency policy, the fabric-wide policy is also overwritten. May not match other databases in the fabric.	Database is not protected. Automatically distributes activated changes to other v6.2.0 or later switches in the fabric. May not match other databases in the fabric.	Database is not protected. Automatically distributes activated changes to all switches in the fabric. Fabric can only contain switches running Fabric OS v6.2.0 or later. Active database is the same for all switches in the fabric.

1. An error is returned indicating that the distribution setting must be accept before you can set the fabric-wide consistency policy.

## Database distribution settings

The distribution settings control whether a switch accepts or rejects distributions of databases from other switches and whether the switch may initiate a distribution. Configure the distribution setting to reject when maintaining the database on a per-switch basis.

[Table 38](#) lists the databases supported in Fabric OS v6.2.0 and later switches.

**TABLE 38** Supported policy databases

Database type	Database identifier (ID)
Authentication policy database	AUTH
DCC policy database	DCC
FCS policy database	FCS
IP Filter policy database	IPFILTER
Password database	PWD
SCC policy database	SCC

Use the **chassisDistribute** command to distribute IP filter policies. To distribute other security policies, use the **distribute** command.

### *Displaying the database distribution settings*

1. Connect to the switch and log in using an account with admin permissions, or an account with OM permissions for the FabricDistribution RBAC class of commands.
2. Enter the **fddcfg --showall** command.

### Example shows the database distribution settings

```
switch:admin> fddcfg --showall
Local Switch Configuration for all Databases:-
  DATABASE - Accept/Reject
-----
          SCC -          accept
          DCC -          accept
          PWD -          accept
          FCS -          accept
          AUTH -         accept
          IPFILTER -     accept

Fabric Wide Consistency Policy:- ""
```

### *Enabling local switch protection*

1. Connect to the switch and log in using an account with admin permissions, or an account with OM permissions for the FabricDistribution RBAC class of commands.
2. Enter the **fddCfg --localreject** command.

### *Disabling local switch protection*

1. Connect to the switch and log in using an account with admin permissions, or an account with OM permissions for the FabricDistribution RBAC class of commands.
2. Enter the **fddCfg --localaccept** command.

## ACL policy distribution to other switches

This section explains how to manually distribute local ACL policy databases. The **distribute** command has the following dependencies:

- All target switches must be running Fabric OS v6.2.0 or later.
- All target switches must accept the database distribution (see [“Database distribution settings”](#) on page 161).
- The fabric must have a tolerant or no (absent) fabric-wide consistency policy (see [“Fabric-wide enforcement”](#) on page 163).

If the fabric-wide consistency policy for a database is strict, the database cannot be manually distributed. When you set a strict fabric-wide consistency policy for a database, the distribution mechanism is automatically invoked whenever the database changes.

- The local distribution setting must be accepted. To be able to initiate the distribute command, set the local distribution to accept.

### *Distributing the local ACL policies*

1. Connect to the switch and log in using an account with admin permissions, or an account with OM permissions for the FabricDistribution RBAC class of commands.
2. Enter the **distribute -p** command.



## Fabric-wide enforcement

The fabric-wide consistency policy enforcement setting determines the distribution behavior when changes to a policy are activated. Using the tolerant or strict fabric-wide consistency policy ensures that changes to local ACL policy databases are automatically distributed to other switches in the fabric.

### NOTE

To completely remove all policies from a fabric enter the **fddCfg --fabwideset ""** command.

When you set the fabric-wide consistency policy using the **fddCfg** command with the **--fabwideset database\_id** option, both the fabric-wide consistency policy and specified database are distributed to the fabric. The active policies of the specified databases overwrite the corresponding active and defined policies on the target switches.

Policy changes that are saved but not activated are stored locally until a policy database change is activated. Activating a policy automatically distributes the Active policy set for that policy type (SCC, DCC, FCS, or any combination of the three) to the other switches in the fabric.

### NOTE

FC routers cannot join a fabric with a strict fabric-wide consistency policy. FC routers do not support the fabric-wide consistency policies.

[Table 39](#) describes the fabric-wide consistency settings.

**TABLE 39 Fabric-wide consistency policy settings**

Setting	Value	When a policy is activated
Absent	null	Database is not automatically distributed to other switches in the fabric.
Tolerant	<i>database_id</i>	All updated and new policies of the type specified (SCC, DCC, FCS, or any combination) are distributed to all Fabric v6.2.0 and later switches in the fabric.
Strict	<i>database_id:S</i>	All updated and new policies of the type specified (SCC, DCC, FCS, or any combination) are distributed to all switches in the fabric.

### *Displaying the fabric-wide consistency policy*

1. Connect to the switch and log in using an account with admin permissions, or an account with O permission for the FabricDistribution RBAC class of commands.
2. Enter the **fddCfg --showall** command.

**Example shows policies for a fabric where no consistency policy is defined.**

```
switch:admin> fddcfg --showall
Local Switch Configuration for all Databases:-
  DATABASE - Accept/Reject
-----
          SCC - accept
          DCC - accept
          PWD - accept
          FCS - accept
          AUTH - accept
          IPFILTER - accept

Fabric Wide Consistency Policy:- ""
```

### *Setting the fabric-wide consistency policy*

1. Connect to the switch and log in using an account with admin permissions, or an account with OM permissions for the FabricDistribution RBAC class of commands.
2. Enter the `fddCfg --fabwideset` command.

Example shows how to set a strict SCC and tolerant DCC fabric-wide consistency policy.

```
switch:admin> fddcfg --fabwideset "SCC:S;DCC"
switch:admin> fddcfg --showall
Local Switch Configuration for all Databases:-
      DATABASE - Accept/Reject
-----
          SCC -      accept
          DCC -      accept
          PWD -      accept
          FCS -      accept
          AUTH -     accept
          IPFILTER -  accept

Fabric Wide Consistency Policy:- "SCC:S;DCC"
```

### Notes on joining a switch to the fabric

When a switch is joined to a fabric with a tolerant SCC, DCC, or FCS fabric-wide consistency policy, the joining switch must have a matching tolerant SCC, DCC, or FCS fabric-wide consistency policy. If the tolerant SCC, DCC, or FCS fabric-wide consistency policies do not match, the switch can join the fabric, but an error message flags the mismatch. If the tolerant SCC, DCC, and FCS fabric-wide consistency policies match, the corresponding SCC, DCC, and FCS ACL policies are compared.

The enforcement of fabric-wide consistency policy involves comparison of only the Active policy set. If the ACL policies match, the switch joins the fabric successfully. If the ACL policies are absent on the switch or on the fabric, the switch joins the fabric successfully, and the ACL policies are copied automatically from where they exist to where they are absent. The Active policies set where they exist and overwrite the Active and Defined policies where they are absent. If the ACL policies do not match, the switch can join the fabric, but an error message flags the mismatch.

Under both conflicting conditions, **secPolicyActivate** is blocked in the merged fabric. Use the `fddCfg --fabwideset` command to resolve the fabric-wide consistency policy conflicts. Use the `distribute` command to explicitly resolve conflicting ACL policies.

When a switch is joined to a fabric with any strict fabric-wide consistency policy, the joining switch must have a matching fabric-wide consistency policy. If the fabric-wide consistency policies do not match, the switch cannot join the fabric and the neighboring E\_Ports are disabled. If the fabric-wide consistency policies match, the corresponding SCC, DCC, and FCS ACL policies are compared.

The enforcement of fabric-wide consistency policy involves comparison of only the Active policy set. If the ACL policies match, the switch joins the fabric successfully. If the ACL policies are absent either on the switch or on the fabric, the switch joins the fabric successfully, and the ACL policies are copied automatically from where they are present to where they are absent. The Active policy set where it is present overwrites the Active and Defined policy set where it is absent. If the ACL policies do not match, the switch cannot join the fabric and the neighboring E\_Ports are disabled.

Use the **fddCfg --fabwideset** command on either this switch or the fabric to set a matching strict SCC, DCC, or FCS fabric-wide consistency policy. Use ACL policy commands to delete the conflicting ACL policy from one side to resolve ACL policy conflict. If neither the fabric nor the joining switch is configured with a fabric-wide consistency policy, there are no ACL merge checks required.

The descriptions above also apply to joining two fabrics. In this context, the joining switch becomes a joining fabric.

### *Matching fabric-wide consistency policies*

This section describes the interaction between the databases with active SCC and DCC policies and combinations of fabric-wide consistency policy settings when fabrics are merged.

For example: Fabric A with SCC:S;DCC (strict SCC and tolerant DCC) joins Fabric B with SCC:S;DCC (strict SCC and tolerant DCC), the fabrics can merge as long as the SCC policies match, including the order SCC:S;DCC and if both are set to strict.

[Table 40](#) describes the impact of merging fabrics with the same fabric-wide consistency policy that have SCC, DCC, or both policies.

**TABLE 40** Merging fabrics with matching fabric-wide consistency policies

Fabric-wide consistency policy	Fabric A ACL policies	Fabric B ACL policies	Merge results	Database copied
None	None	None	Succeeds	No ACL policies copied.
	None	SCC/DCC	Succeeds	No ACL policies copied.
Tolerant	None	None	Succeeds	No ACL policies copied.
	None	SCC/DCC	Succeeds	ACL policies are copied from B to A.
	SCC/DCC	SCC/DCC	Succeeds	If A and B policies do not match, a warning displays and policy commands are disabled <sup>1</sup> .
Strict	None	None	Succeeds	No ACL policies copied.
	None	SCC/DCC	Succeeds	ACL policies are copied from B to A.
	Matching SCC/DCC	Matching SCC/DCC	Succeeds	No ACL policies copied.
	Different SCC/DCC policies	Different SCC/DCC policies	Fails	Ports are disabled.

1. To resolve the policy conflict, manually distribute the database you want to use to the switch with the mismatched database. Until the conflict is resolved, commands such as **fddCfg --fabwideset** and **secPolicyActivate** are blocked.

### *Non-matching fabric-wide consistency policies*

You may encounter one of the following two scenarios described in [Table 41](#) and [Table 42](#) where you are merging a fabric with a strict policy to a fabric with an absent, tolerant, or non-matching strict policy and the merge fails and the ports are disabled.

[Table 41](#) on page 166 shows merges that are not supported.

**TABLE 41** Examples of strict fabric merges

Fabric-wide consistency policy setting			Expected behavior
	Fabric A	Fabric B	
Strict/Tolerant	SCC:S;DCC:S	SCC;DCC:S	Ports connecting switches are disabled.
	SCC;DCC:S	SCC:S;DCC	
	SCC:S;DCC	SCC:S	
Strict/Absent	SCC:S;DCC:S		
	SCC:S		
	DCC:S		
Strict/Strict	SCC:S	DCC:S	

Table 42 has a matrix of merging fabrics with tolerant and absent policies.

**TABLE 42** Fabric merges with tolerant and absent combinations

Fabric-wide consistency policy setting			Expected behavior
	Fabric A	Fabric B	
Tolerant/Absent	SCC;DCC		Error message logged. Run <code>fddCfg --fabwideset "policy_ID"</code> from any switch with the desired configuration to fix the conflict. The <code>secPolicyActivate</code> command is blocked until conflict is resolved.
	DCC		
	SCC;DCC	SCC	
	DCC	SCC	

## Management interface security

You can secure an Ethernet management interface between two Brocade switches or Backbones by implementing IPsec and IKE policies to create a tunnel that protects traffic flows. The tunnel has at each end a Brocade switch or Backbone. There may be routers, gateways, and firewalls in between the two ends.

### ATTENTION

Enabling secure IPsec tunnels does not provide IPsec protection for traffic flows on the external management interfaces of intelligent blades in a chassis, nor does it support protection of traffic flows on FCIP interfaces.

Internet Protocol security (IPsec) is a framework of open standards that ensures private and secure communications over Internet Protocol (IP) networks through the use of cryptographic security services. The goal of IPsec is to provide the following capabilities:

- **Authentication** – Ensures that the sending and receiving end-users and devices are known and trusted by one another.
- **Data Integrity** – Confirms that the data received was in fact the data transmitted.
- **Data Confidentiality** – Protects the user data being transmitted, such as utilizing encryption to avoid sending data in clear text.
- **Replay Protection** – Prevents replay attack in which an attacker resends previously-intercepted packets in an effort to fraudulently authenticate or otherwise masquerade as a valid user.

- **Automated Key Management**—Automates the process, as well as manages the periodic exchange and generation of new keys.

Using the `ipsecConfig` command, you must configure multiple security policies for traffic flows on the Ethernet management interfaces based on IPv4 or IPv6 addresses, a range of IPv4 or IPv6 addresses, the type of application, port numbers, and protocols used (UDP/TCP/ICMP). You must specify the transforms and processing choices for the traffic flow (drop, protect or bypass). Also, you must select and configure the key management protocol using an automatic or manual key.

For more information on IPv4 and IPv6 addressing, refer to [Chapter 2, “Performing Basic Configuration Tasks”](#).

## Configuration examples

Below are several examples of various configurations you can use to implement an IPsec tunnel between two devices. You can configure other scenarios as nested combinations of these configurations.

### *Endpoint-to-endpoint transport or tunnel*

In this scenario, both endpoints of the IP connection implement IPsec, as required of hosts in RFC4301. Transport mode encrypts only the payload while tunnel mode encrypts the entire packet. A single pair of addresses will be negotiated for packets protected by this SA.

It is possible in this scenario that one or both of the protected endpoints will be behind a network address translation (NAT) node, in which case tunneled packets will have to be UDP-encapsulated so that port numbers in the UDP headers can be used to identify individual endpoints behind the NAT.



**FIGURE 14** Protected endpoints configuration

A possible drawback of end-to-end security is that various applications that require the ability to inspect or modify a transient packet will fail when end-to-end confidentiality is employed. Various QoS solutions, traffic shaping, and firewalling applications will be unable to determine what type of packet is being transmitted and will be unable to make the decisions that they are supposed to make.

### *Gateway-to-gateway tunnel*

In this scenario, neither endpoint of the IP connection implements IPsec, but the network nodes between them protect traffic for part of the way. Protection is transparent to the endpoints, and depends on ordinary routing to send packets through the tunnel endpoints for processing. Each endpoint would announce the set of addresses behind it, and packets would be sent in tunnel mode where the inner IP header would contain the IP addresses of the actual endpoints.

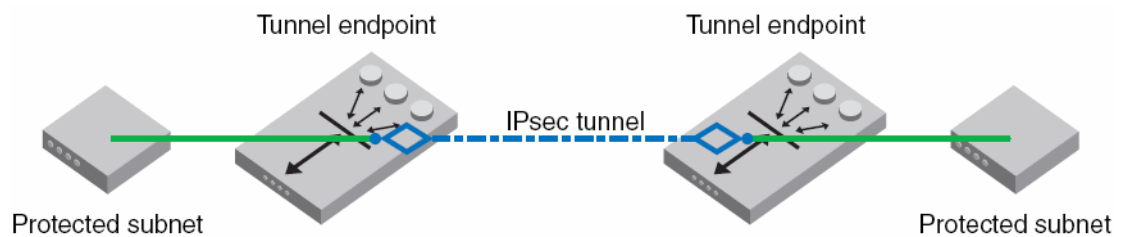

FIGURE 15 Gateway tunnel configuration

### *Endpoint-to-gateway tunnel*

In this scenario, a protected endpoint (typically a portable computer) connects back to its corporate network through an IPsec-protected tunnel. It might use this tunnel only to access information on the corporate network, or it might tunnel all of its traffic back through the corporate network in order to take advantage of protection provided by a corporate firewall against Internet-based attacks. In either case, the protected endpoint will want an IP address associated with the security gateway so that packets returned to it will go to the security gateway and be tunneled back.

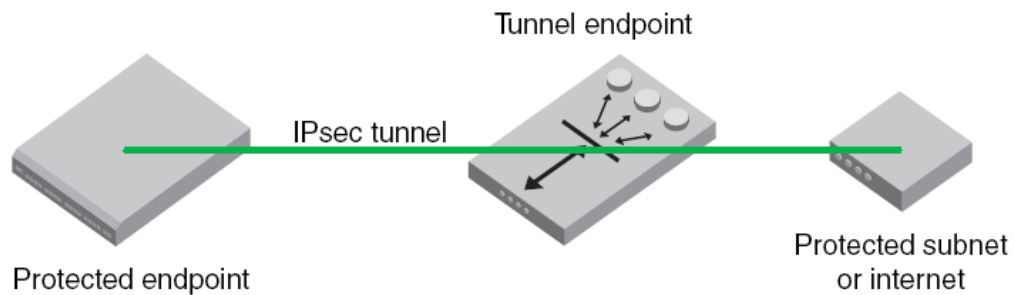

FIGURE 16 Endpoint-to-gateway tunnel configuration

### *RoadWarrior configuration*

In endpoint-to-endpoint security, packets are encrypted and decrypted by the host which produces or consumes the traffic. In the gateway-to-gateway example, a router on the network encrypts and decrypts the packets on behalf of the hosts on a protected network. A combination of the two is referred to as a RoadWarrior configuration where a host on the Internet requires access to a network through a security gateway that is protecting the network.

## IPsec protocols

IPsec ensures confidentiality, integrity, and authentication using the following protocols:

- Authentication Header (AH)
- Encapsulating Security Payload (ESP)

IPsec protocols protect IP datagram integrity using hash message authentication codes (HMAC). Using hash algorithms with the contents of the IP datagram and a secret key, the IPsec protocols generate this HMAC and add it to the protocol header. The receiver must have access to the secret key in order to decode the hash.

IPsec protocols use a sliding window to assist in flow control. The IPsec protocols also use this sliding window to provide protection against replay attacks in which an attacker attempts a denial of service attack by replaying an old sequence of packets. IPsec protocols assign a sequence number to each packet. The recipient accepts each packet only if its sequence number is within the window. It discards older packets.

## Security associations

A security association (SA) is the collection of security parameters and authenticated keys that are negotiated between IPsec peers to protect the IP datagram. A security association database (SADB) is used to store these SAs. Information in these SAs—IP addresses, secret keys, algorithms, and so on—is used by peers to encapsulate and decapsulate the IPsec packets.

An IPsec security association is a construct that specifies security properties that are recognized by communicating hosts. The properties of the SA are the security protocol (AH or ESP), destination IP address, and Security Parameter Index (SPI) number. SPI is an arbitrary 32-bit value contained in IPsec protocol headers (AH or ESP) and an IPsec SA is unidirectional. Because most communication is peer-to-peer or client-to-server, two SAs must be present to secure traffic in both directions. An SA specifies the IPsec protocol (AH or ESP), the algorithms used for encryption and authentication, and the expiration definitions used in security associations of the traffic. IKE uses these values in negotiations to create IPsec SAs. You must create an SA prior to creating an SA-proposal. You cannot modify an SA once it is created. Use the `ipsecConfig --flush manual-sa` command to remove all SA entries from the kernel SADB and re-create the SA. For more information on the `ipsecConfig` command, refer to the *Fabric OS Command Reference*.

### *IPsec proposal*

The IPsec sa-proposal defines an SA or an SA bundle. An SA is a set of parameters that define how the traffic is protected using IPsec. These are the IPsec protocols to use for an SA, either AH or ESP, and the encryption and authentication algorithms to use to protect the traffic. For SA bundles, [AH, ESP] is the supported combination.

## Authentication and encryption algorithms

IPsec uses different protocols to ensure the authentication, integrity, and confidentiality of the communication. Encapsulating Security Payload (ESP) provides confidentiality, data integrity and data source authentication of IP packets, and protection against replay attacks. Authentication Header (AH) provides data integrity, data source authentication, and protection against replay attacks, but unlike ESP, AH does not provide confidentiality.

In AH and ESP, `hmac_md5` and `hmac_sha1` are used as authentication algorithms. Only in ESP, `3des_cbc`, `blowfish_cbc`, `aes256_cbc` and `null_enc` are used as encryption algorithms. Use [Table 43](#) when configuring the authentication algorithm.

**TABLE 43** Algorithms and associated authentication policies

Algorithm	Encryption Level	Policy	Description
<code>hmac_md5</code>	128-bit	AH, ESP	A stronger MAC because it is a keyed hash inside a keyed hash. When MD5 or SHA-1 is used in the calculation of an HMAC; the resulting MAC algorithm is termed HMAC-MD5 or HMAC-SHA-1 accordingly.
<code>hmac_sha1</code>	160-bit	AH, ESP	

**NOTE:** The MD5 hash algorithm is blocked when FIPS mode is enabled

**TABLE 43 Algorithms and associated authentication policies (Continued)**

Algorithm	Encryption Level	Policy	Description
3des_cbc	168-bit	ESP	Triple DES is a more secure variant of DES. It uses three different 56-bit keys to encrypt blocks of 64-bit plain text. The algorithm is FIPS-approved for use by Federal agencies.
blowfish_cbc	64-bit	ESP	Blowfish is a 32-bit to 448-bit keyed, symmetric block cipher.
aes128_cbc	128-bit	ESP	Advanced Encryption Standard is a 128- or 256-bit fixed block size cipher.
aes256_cbc	256-bit	ESP	
null_enc	n/a	ESP	A form of plaintext encryption.

## IPsec policies

An IPsec policy determines the security services afforded to a packet and the treatment of a packet in the network. An IPsec policy allows classifying IP packets into different traffic flows and specifies the actions or transformations performed on IP packets on each of the traffic flows. The main components of an IPsec policy are: IP packet filter and selector (IP address, protocol, and port information) and transform set.

### *IPsec traffic selector*

The traffic selector is a traffic filter that defines and identifies the traffic flow between two systems that have IPsec protection. IP addresses, the direction of traffic flow (inbound, outbound) and the upper layer protocol are used to define a filter for traffic (IP datagrams) that is protected using IPsec.

### *IPsec transform*

A *transform set* is a combination of IPsec protocols and cryptographic algorithms that are applied on the packet after it is matched to a selector. The transform set specifies the IPsec protocol, IPsec mode and action to be performed on the IP packet. It specifies the key management policy that is needed for the IPsec connection and the encryption and authentication algorithms to be used in security associations when IKE is used as the key management protocol.

IPsec can protect either the entire IP datagram or only the upper-layer protocols using *tunnel mode* or *transport mode*. Tunnel mode uses the IPsec protocol to encapsulate the entire IP datagram. Transport mode handles only the IP datagram payload.

## IKE policies

When IKE is used as the key management protocol, IKE policy defines the parameters used in IKE negotiations needed to establish IKE SA and parameters used in negotiations to establish IPsec SAs. These include the authentication and encryption algorithms, and the primary authentication method, such as preshared keys, or a certificate-based method, such as RSA signatures.



## *Key management*

The IPsec key management supports Internet Key Exchange or Manual key/SA entry. The Internet Key Exchange (IKE) protocol handles key management automatically. SAs require keying material for authentication and encryption. The managing of keying material that SAs require is called *key management*.

The IKE protocol secures communication by authenticating peers and exchanging keys. It also creates the SAs and stores them in the SADB.

The manual key/SA entry requires the keys to be generated and managed manually. For the selected authentication or encryption algorithms, the correct keys must be generated using a third party utility on your LINUX system. The key length is determined by the algorithm selected.

Linux IPsec-tools 0.7 provides tools for manual key entry (MKE) and automatic keyed connections. The LINUX **setKey** command can be used for manually keyed connections, which means that all parameters needed for the setup of the connection are provided by you. Based on which protocol, algorithm, and key used for the creation of the security associations, the switch populates the security association database (SAD) accordingly.

## *Pre-shared keys*

A pre-shared key has the .psk extension and is one of the available methods IKE can be configured to use for primary authentication. You can specify the pre-shared keys used in IKE policies; add and delete pre-shared keys (in local database) corresponding to the identity of the IKE peer or group of peers.

The **ipSecConfig** command does not support manipulating pre-shared keys corresponding to the identity of the IKE peer or group of peers. Use the **secCertUtil** command to import, delete, or display the pre-shared keys in the local switch database. For more information on this procedure, refer to [Chapter 6, “Configuring Protocols”](#).

## *Security certificates*

A certificate is one of the available methods IKE can be configured to use for primary authentication. You can specify the local public key and private key (in X.509 PEM format) and peer public key (in X.509 format) to be used in a particular IKE policy.

Use the **secCertUtil import** command to import public key, private key and peer-public key (in X.509 PEM format) into the switch database. For more information on this procedure, refer to [Chapter 6, “Configuring Protocols”](#).

---

### **ATTENTION**

The CA certificate name must have the **IPSECCA.pem** name.

---

## *Static Security Associations*

Manual Key Entry (MKE) provides the ability to manually add, delete and flush SA entries in the SADB. Manual SA entries may not have an associated IPsec policy in the local policy database. Manual SA entries are persistent across system reboots.

## Creating the tunnel

Each side of the tunnel must be configured in order for the tunnel to come up. Once you are logged into the switch, do not log off as each step requires that you are logged in to the switch. IPsec configuration changes take effect upon execution and are persistent across reboots. Configure the following on each side of the tunnel:

---

### NOTE

A backslash ( \ ) is used to skip the return character so you can continue the command on the next line without the return character being interpreted by the shell.

---

1. Determine the authentication protocol and algorithm to be used on the tunnel.  
Refer to [Table 43](#) on page 169 to determine which algorithm to use in conjunction with a specific authentication protocol.
2. Determine the type of keys to be used on the tunnel.  
If you are using CA signed keys, you must generate them prior to setting up your tunnels.
3. Enable IPsec.
  - a. Connect to the switch and log in using an account with admin permissions, or an account associated with the chassis role and having OM permissions for the IPsec RBAC class of commands.
  - b. Enter the **ipSecConfig --enable** command to enable IPsec on the switch.
4. Create an IPsec SA policy on each side of the tunnel using the **ipSecConfig --add** command.

#### Example of creating an IPsec SA policy

This example creates an IPsec SA policy named *AH01*, which uses AH protection with MD5. You would run this command on each switch; on each side of the tunnel so that both sides have the same IPsec SA policy.

```
switch:admin> ipsecconfig --add policy ips sa -t AH01 -p ah -auth hmac_md5
```

5. Create an IPsec proposal on each side of the tunnel using the **ipSecConfig --add** command.

#### Example of creating an IPsec proposal

This example creates an IPsec proposal *IPSEC-AH* to use *AH01* as SA.

```
switch:admin> ipsecconfig --add policy ips sa-proposal -t IPSEC-AH -sa AH01
```

6. Import the pre-shared key file.  
Refer to [Chapter 6, "Configuring Protocols"](#) for information on how to set up pre-shared keys and certificates.
7. Configure the IKE policy using the **ipSecConfig --add** command.

#### Example of creating an IKE policy

This example creates an IKE policy for the remote peer.

```
switch:admin> ipsecconfig --add policy ike -t IKE01 -remote 10.33.74.13 \  
-id 10.33.69.132 -remoteid 10.33.74.13 -enc 3des_cbc \  
-hash hmac_md5 -prf hmac_md5 -auth psk -dh modp1024 \  
-psk ipseckey.psk
```

8. Create an IPsec transform on each switch using the **ipSecConfig --add** command.

**Example of creating an IPsec transform**

This example creates an IPsec transform TRANSFORM01 to use the transport mode to protect traffic identified for IPsec protection and use IKE01 as key management policy.

```
switch:admin> ipsecconfig --add policy ips transform -t TRANSFORM01 \
-mode transport -sa-proposal IPSEC-AH \
-action protect -ike IKE01
```

9. Create a traffic selector on each switch using the **ipSecConfig --add** command.

**Example of creating a traffic selector**

This example creates a traffic selector to select outbound and inbound traffic that needs to be protected.

```
switch:admin> ipsecconfig --add policy ips selector -t SELECTOR-OUT \
-d out -l 10.33.69.132 -r 10.33.74.13 -transform TRANSFORM01

switch:admin> ipsecconfig --add policy ips selector -t SELECTOR-IN \
-d in -l 10.33.74.13 -r 10.33.69.132 -t transform TRANSFORM01
```

Inbound and outbound selectors use opposite values for local and remote IP addresses. In this example, notice that the local ("-l") address of SELECTOR-OUT is the same as the remote ("-r") address of SELECTOR-IN. Similarly, the local ("-l") address of SELECTOR-IN is the same as the remote ("-r") address of SELECTOR-OUT. That is, "local" refers to the source IP address of the packet, and "remote" is the destination IP address. Hence inbound packets have opposite source and destination addresses than outbound packets.

10. Verify traffic is protected.
  - a. Initiate a telnet, SSH, or ping session from the two switches.
  - b. Verify that IP traffic is encapsulated.
  - c. Monitor IPsec SAs created using IKE for above traffic flow
    - Use the **ipSecConfig --show manual-sa -a** command with the operands specified to display the outbound and inbound SAs in kernel SADB.
    - Use the **ipSecConfig --show policy ips sa -a** command with the specified operands to display all IPsec SA policies.
    - Use the **ipSecConfig --show policy ips sa-proposal -a** command with the specified operands to display IPsec proposals.
    - Use the **ipSecConfig --show policy ips transform -a** command with the specified operands to display IPsec transforms.
    - Use the **ipSecConfig --show policy ips selector -a** command with the specified operands to display IPsec traffic selectors.
    - Use the **ipSecConfig --show policy ike -a** command with the specified operands to display IKE policies.
    - Use the **ipSecConfig --flush manual-sa** command with the specified operands to flush the created SAs in the kernel SADB.

## Example of an End-to-end transport tunnel mode

This example illustrates securing traffic between two systems using AH protection with MD5 and configure IKE with pre-shared keys. The two systems are a switch, BROCADE300 (IPv4 address 10.33.74.13), and an external host (10.33.69.132).

---

### NOTE

A backslash ( \ ) is used to skip the return character so you can continue the command on the next line without the return character being interpreted by the shell.

---

1. On the system console, log in to the switch as Admin.
2. Enable IPsec.
  - a. Connect to the switch and log in using an account with admin permissions, or an account with OM permissions for the IPsec RBAC class of commands.
  - b. Enter the **ipSecConfig --enable** command to enable IPsec on the switch.
3. Create an IPsec SA policy named AH01, which uses AH protection with MD5.

```
switch:admin> ipsecconfig --add policy ips sa -t AH01 \
-p ah -auth hmac_md5
```

4. Create an IPsec proposal IPSEC-AH to use AH01 as SA.

```
switch:admin> ipsecconfig --add policy ips sa-proposal \
-t IPSEC-AH -sa AH01
```

5. Configure the SA proposal's lifetime in time units. The maximum lifetime is 86400, or one day.

```
switch:admin> ipsecconfig --add policy ips sa-proposal \
-t IPSEC-AH -ltime 86400 -sa AH01
```

6. Import the pre-shared key file using the **secCertUtil** command. The file name should have a .psk extension.

For more information on importing the pre-shared key file, refer to [“Installing a switch certificate”](#) on page 123.

7. Configure an IKE policy for the remote peer.

```
switch:admin> ipsecconfig --add policy ike -t IKE01 \
-remote 10.33.69.132 -id 10.33.74.13 -remoteid 10.33.69.132 \
-enc 3des_cbc -hash hmac_md5 -prf hmac_md5 -auth psk \
-dh modp1024 -psk ipseckey.psk
```

---

### NOTE

IKE version ('-v' option) needs to be set to 1 (IKEv1) if remote peer is a Windows XP or 2000 Host as Windows XP and 2000 do not support IKEv2.

---

8. Create an IPsec transform named TRANSFORM01 to use transport mode to protect traffic identified for IPsec protection and use IKE01 as key management policy.

```
switch:admin> ipsecconfig --add policy ips transform \
-t TRANSFORM01 -mode transport -sa-proposal IPSEC-AH -action \
protect -ike IKE01
```

9. Create traffic selectors to select the outbound and inbound traffic that needs to be protected.

```
switch:admin> ipsecconfig --add policy ips selector \
-t SELECTOR-OUT -d out -l 10.33.74.13 -r 10.33.69.132 \
-transform TRANSFORM01
switch:admin> ipsecconfig --add policy ips selector \
-t SELECTOR-IN -d in -l 10.33.69.132 -r 10.33.74.13 \
-transform TRANSFORM01
```

10. Verify the IPsec SAs created with IKE using the **ipsecConfig --show manual-sa -a** command.
11. Perform the equivalent steps on the remote peer to complete the IPsec configuration. Refer to your server administration guide for instructions.
12. Generate IP traffic and verify that it is protected using defined policies.
- Initiate Telnet or SSH or ping session from BRCD300 to Remote Host.
  - Verify that the IP traffic is encapsulated.
  - Monitor IPsec SAs created using IKE for the above traffic flow.
    - Use the **ipSecConfig --show manual-sa -a** command with the operands specified to display the outbound and inbound SAs in the kernel SADB.
    - Use the **ipSecConfig --show policy ips sa -a** command with the specified operands to display all IPsec SA policies.
    - Use the **ipSecConfig --show policy ips sa-proposal -a** command with the specified operands to display IPsec proposals.
    - Use the **ipSecConfig --show policy ips transform -a** command with the specified operands to display IPsec transforms.
    - Use the **ipSecConfig --show policy ips selector -a** command with the specified operands to display IPsec traffic selectors.
    - Use the **ipSecConfig --show policy ike -a** command with the specified operands to display IKE policies.
    - Use the **ipSecConfig --flush manual-sa** command with the specified operands to flush the created SAs in the kernel SADB.



#### CAUTION

Flushing SAs requires IPsec to be disabled and re-enabled. This operation is disruptive to traffic on the tunnel.

---

#### NOTE

As of Fabric OS 7.0.0, IPsec no longer supports null encryption (null\_enc) for IKE policies.

IPv6 policies cannot tunnel IMCP traffic.

---

## 7 Management interface security

# Maintaining the Switch Configuration File

---

## In this chapter

- Configuration settings ..... 177
- Configuration file backup ..... 180
- Configuration file restoration ..... 181
- Configurations across a fabric ..... 185
- Configuration management for Virtual Fabrics ..... 186
- Brocade configuration form ..... 189

## Configuration settings

It is important to maintain consistent configuration settings on all switches in the same fabric because inconsistent parameters, such as inconsistent PID formats, can cause fabric segmentation. As part of standard configuration maintenance procedures, Brocade recommends that you back up all important configuration data for every switch on a host computer server as a safety measure.

---

### NOTE

For information about AD-enabled switches, refer to [Chapter 17, “Managing Administrative Domains”](#).

For more information about troubleshooting configuration file uploads and downloads, refer to the *Fabric OS Troubleshooting and Diagnostics Guide*.

---

There are two ways to view configuration settings for a switch in a Brocade fabric:

- Issue the **configShow -all** command.
 

To display configuration settings, connect to the switch, log in as admin, and enter the **configShow -all** command. The configuration settings vary depending on switch model and configuration. This command does not show as much configuration information as the text file created from the **configUpload** command.
- Issue the **configUpload -all** command to upload an ASCII text file from the switch or switch module.
 

You can open the text file with any text editor to view the configuration information of the switch.



### CAUTION

**Editing of the uploaded file is unsupported and can result in system errors if an edited file is subsequently downloaded.**

---

If your user account has chassis account permissions, you can use any of the following options when uploading or downloading a configuration file:

- fid** To upload the specified FID configuration.
- all** To upload all of the system configuration, including the chassis section and all switch sections for all logical switches.  
**Note:** Use this parameter when obtaining a complete capture of the switch configuration in a switch that has Virtual Fabric mode disabled.
- chassis** To upload only the chassis section of the system configuration file.

### Configuration file format

The configuration file is divided into three areas: the header, the chassis section, and one or more switch sections.

Following is an example of a configuration file with two switch sections.

```
[Configuration upload Information]
Configuration Format = 3.0
Minimum Compatible Format = 3.0
Excluding Format = 0.0
date = Tue Mar 1 15:53:18 2011
FOS version = v7.0.0.0
Number of LS = 2

[Chassis Configuration Begin]

[fcRouting]

[Chassis Configuration]

[LicensesDB]

[Bottleneck Configuration]

[DMM_WWN]

[Licenses]

[Chassis Configuration End]
date = Tue Mar 1 21:28:52 2011

[Switch Configuration Begin : 0]
SwitchName = Sprint5100
Fabric ID = 128

[Boot Parameters]

[Configuration]

[Bottleneck Configuration]

[Zoning]

[Defined Security policies]
```



```

[Active Security policies]

[cryptoDev]

[FICU SAVED FILES]

[Banner]

[End]
[Switch Configuration End : 0]
date = Tue Mar 1 21:28:52 2011

[Switch Configuration Begin : 1]
SwitchName = switch_2
Fabric ID = 1

[Boot Parameters]

[Configuration]

[Bottleneck Configuration]

[Zoning]

[Defined Security policies]

[Active Security policies]

[cryptoDev]

[FICU SAVED FILES]

[Banner]

[End]
[Switch Configuration End : 1]

```

### ***Chassis section***

There is only one chassis section within a configuration. It defines configuration data for chassis components that affect the entire system, not just one individual logical switch. The chassis section is included in non-Virtual Fabric modes only if you use the **configUpload -all** command.

The chassis section specifies characteristics for the following software components:

- FC Routing – Fibre Channel Routing
- Chassis configuration – Chassis configuration
- FCOE\_CH\_CONF – FCoE chassis configuration
- UDROLE\_CONF – User defined role configuration
- LicensesDB – License Database (slot based)
- DMM\_WWN – Data migration manager World Wide Name configuration
- Licenses – (Feature based) Licenses configuration
- AGWWN\_MAPPING\_CONF – Access Gateway WWN mapping configuration

- LicensesLservc – Sentinel License configuration
- GE blade mode – GigE Mode Configuration
- FWD CHASSIS CFG – Fabric watch configuration
- FRAME LOG – Frame log configuration (enable/disable)
- DMM\_TB – Data migration manager configuration
- MOTD – Message of the day

### *Switch section*

There is always at least one switch section for the default switch or a switch that has Virtual Fabric mode disabled, and there are additional sections corresponding to each additionally defined logical switch instance on a switch with Virtual Fabric mode enabled. This data is switch-specific and affects only that logical switch behavior.

The switch section of the configuration file contains information for all of the following:

- Boot parameters
- Configuration
- Bottleneck configuration
- FCoE software configuration
- Zoning
- Defined security policies
- Active security policies
- iSCSI
- CryptoDev
- FICU saved files
- VS\_SW\_CONF
- Banner

## Configuration file backup

Brocade recommends keeping a backup configuration file. You should keep individual backup files for all switches in the fabric and avoid copying configurations from one switch to another. The **configUpload** command, by default, only uploads the switch context configuration for the logical switch context in which the command is executed.

In non-Virtual Fabric mode, you must use the **configUpload -all** command to include both the switch and the chassis information. In Virtual Fabric mode, the **configUpload -all** command can be selected to upload all logical switches and the chassis configuration. Only administrators with chassis permissions are allowed to upload other FIDs or the chassis configuration.

The following information is *not saved* in a backup:

- **dnsConfig** information
- Passwords

Before you upload a configuration file, verify that you can reach the FTP server from the switch. Using a Telnet connection, save a backup copy of the configuration file from a logical switch to a host computer.

Secure File Transfer Protocol is now an option when uploading a configuration file. SFTP is analogous to SCP (secure copy) and appears as an option for the **configupload/download**, **supportsave**, **auto FFDC/trace upload (supportftp)** commands.

## Uploading a configuration file in interactive mode

1. Verify that the FTP, SFTP, or SCP service is running on the host computer.
2. Connect to the switch and log in using an account with admin permissions.
3. Enter the **configUpload** command. The command becomes interactive and you are prompted for the required information.
4. Store a soft copy of the switch configuration information in a safe place for future reference.

---

### NOTE

The configuration file is printable, but you may want to see how many pages will be printed before you send it to the printer.

---

#### Example of configUpload on a switch without Admin Domains

```
switch:admin> configupload
Protocol (scp, ftp, sftp, local) [ftp]: sftp
Server Name or IP Address [host]: 10.1.2.3
User Name [user]: UserFoo
Path/Filename [<home dir>/config.txt]: switchConfig.txt
Section (all|chassis|FID# [all]): chassis
username@10.1.2.3's password:
Password: <hidden>

configUpload complete
```

#### Example of configUpload on a switch with Admin Domains

---

### NOTE

AD domains other than AD255 upload a subset of information. If you want a complete switch configuration, you must use the **configUpload** command while logged in to AD255.

---

```
switch:AD5:admin> ad --select 5
switch:AD5:admin> configUpload
Protocol (scp or ftp) [ftp]:
Server Name or IP Address [host]: 10.1.2.3
User Name [user]: UserFoo
Path/Filename [<home dir>/config.txt]: /pub/configurations/config.txt
Password: <hidden>
configUpload complete: Only zoning parameters are uploaded from ad5.
```

## Configuration file restoration

When you restore a configuration file, you overwrite the existing configuration with a previously saved backup configuration file.



**CAUTION**

Make sure that the configuration file you are downloading is compatible with your switch model. Downloading a configuration file from a different switch model or from a different firmware could cause your switch to fail.



**CAUTION**

If you have Virtual Fabrics enabled, you must follow the procedure in [“Configuration management for Virtual Fabrics”](#) on page 186 to restore the logical switches.

If a **configDownload** command is issued on a non-FC router, any FC router parameters may be viewed in the downloaded data. This is harmless to the switch and can be ignored.

Note that while it is possible to transfer a v6.4.1 config file to a v7.0.0 switch, the reverse cannot be done. You cannot transfer a v7.0.0 config file to a v6.4.1 switch.

## Restrictions

**-chassis** The number of switches defined in the downloaded configuration file must match the number of switches currently defined on the switch.

**-fid FID** The FID must be defined in both the downloaded configuration file and the current system.

---

**NOTE**

Brocade recommends you disable a switch before downloading a configuration file. If you plan to download a configuration file while the switch is enabled, see [“Configuration download without disabling a switch”](#) on page 184.

---

**-fid FID -sfid FID** The FID must be defined on the switch and the source FID must be defined in the downloaded configuration file.

- all** The number of switches or FIDs defined in the downloaded configuration file must match the number of switches or FIDs currently defined on the switch.
- The switches must be disabled first. If they are not, the **configDownload** command will download the configuration for as many switches as possible until a non-disabled switch is found. Then it will stop. Before running the **configDownload** command, verify if any switches need to be disabled.
- If you are performing a configuration download due to a configuration error, it is highly recommended to run the **configDefault** command before running the **configDownload** command. Refer to “[Configuration download without disabling a switch](#)” on page 184 for more information on non-disruptive configuration downloads.
- If Virtual Fabrics mode is enabled, the **chassisDisable** and **chassisEnable** commands are used to disable all logical switches on the affected switch. This bypasses the need to disable and enable each switch individually once the configuration download has completed.
- Non-Virtual Fabric configuration files downloaded to a Virtual Fabric system have configuration applied only to the default switch. If there are multiple logical switches created in a Virtual Fabric-enabled system, there could be some issues if there are ports that belong to the default switch in a Virtual Fabric-disabled system, but are now assigned to logical switches in a Virtual Fabric-enabled system. Only configurations related to ports within the default switch are applied.

If you need to set up your switch again, run the commands listed in [Table 44](#) and save the output in a file format. Store the files in a safe place for emergency reference.

**TABLE 44** CLI commands to display or modify switch configuration information

Command	Displays
configShow	System configuration parameters, settings, and license information.
fcLunQuery	LUN IDs and LUNs for all accessible targets.
fcRouterPortCost	FC Router route information.
fcxlateConfig	Translate (xlate) domain's domain ID for both EX_Port-attached fabric and backbone fabric.
fosConfig	Fabric OS features.
ipAddrShow	IP address.
isnscCfg	Configuration state of the iSNS client operation.
licenseShow	License keys installed with more detail than the license information from the <b>configShow</b> command.
portCfgEXPort	EX_Port configuration parameters.
portCfgVEXPort	VEX_Port configuration parameters.



#### CAUTION

Though the switch itself has advanced error checking, the **configdownload** feature within Fabric OS was not designed for users to edit, and is limited in its ability. Edited files can therefore become corrupted and can lead to switch failures.

## Configuration download without disabling a switch

You can download configuration files to a switch while the switch is enabled; that is, you do not need to disable the switch for changes in SNMP, Fabric Watch, or ACL parameters. However, if there is any changed parameter that does not belong to SNMP, Fabric Watch, or ACL, then you must disable the switch. When you use the **configDownload** command, you are prompted to disable the switch *only when necessary*.

Configuration download without disabling a switch is independent of the hardware platform and supported on all hardware platforms running Fabric OS v6.1.0 and later.

---

### ATTENTION

The configuration download process can only restore logical switches that already exist and with the same FIDs. It cannot be used to clone or repair the current switch because the **configDownload** command cannot create logical switches if they do not exist.

---

### *Restoring a configuration*



#### CAUTION

**Using the SFID parameter erases all configuration information on the logical switch. Use the SFID parameter only when the logical switch has no configuration information you want to save.**

1. Verify that the FTP service is running on the server where the backup configuration file is located.
2. Connect to the switch and log in using an account with admin permissions, and if necessary with chassis permissions.
3. If there are any changed parameters in the configuration file that do not belong to SNMP, Fabric Watch, or ACL, disable the switch by entering the **switchDisable** command.
4. Enter the **configDownload** command.  
The command becomes interactive and you are prompted for the required information.
5. At the “Do you want to continue [y/n]” prompt, enter **y**.  
Wait for the configuration to be restored.
6. If you disabled the switch, enter the **switchEnable** command when the process is finished.

---

### NOTE

Because some configuration parameters require a reboot to take effect, after you download a configuration file, you must reboot to be sure that the parameters are enabled. Before the reboot, this type of parameter is listed in the configuration file, but it is not effective until after the reboot.

On dual-CP platforms, you must reboot both CPs simultaneously for changes to take effect.

---

#### Example of configDownload without Admin Domains

```
switch:admin> configdownload
Protocol (scp, ftp, local) [ftp]:
Server Name or IP Address [host]: 10.1.2.3
User Name [user]: UserFoo
Path/File name [<home dir>/config.txt]:
```

```
Section (all|chassis|FID# [all]): all
```

```
*** CAUTION ***
```

This command is used to download a backed-up configuration for a specific switch. If using a file from a different switch, this file's configuration settings will override any current switch settings. Downloading a configuration file, which was uploaded from a different type of switch, may cause this switch to fail. A switch reboot might be required for some parameter changes to take effect.

configDownload operation may take several minutes to complete for large files.

Do you want to continue [y/n]: y

Password: **<hidden>**

configDownload complete.

#### Example of configDownload with Admin Domains

```
switch:AD5:admin>configdownload
Protocol (scp or ftp) [ftp]:
Server Name or IP Address [host]: 10.1.2.3
User Name [user]: UserFoo
Path/Filename [<home dir>/config.txt]: /pub/configurations/config.txt
```

```
*** CAUTION ***
```

This command is used to download a backed-up configuration for a specific switch. If using a file from a different switch, this file's configuration settings will override any current switch settings. Downloading a configuration file, which was uploaded from a different type of switch, may cause this switch to fail. A switch reboot might be required for some parameter changes to take effect.

configDownload operation may take several minutes to complete for large files.

Do you want to continue [y/n]: y

Password: **<hidden>**

Activating configDownload: Switch is disabled

configDownload complete: Only zoning parameters are downloaded to ad5.

#### Example of a non-interactive download of all configurations (chassis + switches)

```
configdownload -a -ftp
10.1.2.3,UserFoo,/pub/configurations/config.txt,password
```

## Configurations across a fabric

To save time when configuring fabric parameters and software features, you can save a configuration file from one switch and download it to other switches of the same model type, as shown in the following procedure.

Do not download a configuration file from one switch to another switch that is a different model or runs a different firmware version, because it can cause the switch to fail. If you need to reset affected switches, issue the **configDefault** command after download is completed but before the switch is enabled. If a switch is enabled with a duplicate domain ID, the switch becomes segmented.

### Downloading a configuration file from one switch to another same model switch

1. Configure one switch.
2. Use the **configUpload** command to save the configuration information. Refer to “[Configuration file backup](#)” on page 180 for more information.
3. Run **configDefault** on each of the target switches, and then use the **configDownload** command to download the configuration file to each of the target switches. Refer to “[Configuration file restoration](#)” on page 181 for more information.

### Security considerations

Security parameters and the switch identity cannot be changed by the **configDownload** command. Parameters such as the switch name and IP address (lines in the configuration file that begin with “boot”) are ignored. Security parameters (lines in the configuration file that begin with “sec”), such as secure mode setting and version stamp, are ignored.

For more detailed information on security, refer to [Chapter 6, “Configuring Protocols”](#).

## Configuration management for Virtual Fabrics

You can use the **configUpload -vf** or **configDownload -vf** command to restore configurations to a logical switch. The **-vf** option only restores the Virtual Fabrics configuration information on to a switch of the same model.

The Virtual Fabrics configuration on the switch defines all of the logical switches allowed and configured for a particular platform.

### Uploading a configuration file from a switch with Virtual Fabrics enabled

The **configUpload** command with the **-vf** option specifies that configuration upload will upload the Virtual Fabrics configuration instead of the non-Virtual Fabrics configuration information.

You must specify a filename with the **configUpload -vf** command. It is recommended not to use **config.txt** for a filename as this can easily be confused with a normal uploaded configuration file.

#### Example of configUpload on a switch with Virtual Fabrics

```
Sprint5100:FID128:admin> configupload
Protocol (scp, ftp, sftp, local) [ftp]:
Server Name or IP Address [host]: 10.1.2.3
User Name [user]: UserFoo
Path/File name [<home dir>/config.txt]: 5100.txt
```



```
Potentially remote file may get overwritten
Section (all|chassis|FID# [all]):
Password: <hidden>
```

```
configUpload complete: All selected config parameters are uploaded
```

#### Example of configUpload of a logical switch configuration

```
DCX_80:FID128:admin> configupload -vf
Protocol (scp, ftp, sftp, local) [ftp]:
Server Name or IP Address [host]: 10.1.2.3
User Name [user]: anonymous
Path/Filename [<home dir>/config.txt]:

configUpload complete: VF config parameters are uploaded
2009/07/20-09:13:40, [LOG-1000], 225, SLOT 7 | CHASSIS, INFO, BrocadeDCX,
Previous message repeated 7 time(s)
2009/07/20-10:27:14, [CONF-1001], 226, SLOT 7 | FID 128, INFO, DCX_80,
configUpload completed successfully for VF config parameters.
```

## Restoring logical switch configuration using configDownload

The **configDownload -vf** command specifies that the Virtual Fabrics configuration download file is downloaded instead of the regular configuration. After the Virtual Fabrics configuration file is downloaded, the switch is automatically rebooted.

On dual-CP platforms, if CPs are incompatible (HA not in sync), the Virtual Fabrics configuration file is not propagated to the standby CP. Otherwise, the active CP attempts to remain active after the reboot, and the new Virtual Fabrics configuration file is then propagated to the standby CP.



### CAUTION

**You must issue the configDownload command on the switch after restoring the Virtual Fabrics configuration to fully restore your switch or chassis configuration.**

1. Connect to the switch and log in using an account with admin permissions.
2. Enter the **configDownload -vf** command.
3. Respond to the prompts.

Wait for the configuration file to download onto the switch. You may need to reconnect to the switch.

4. Enter the **configDownload** command.
5. Respond to the prompts.  
Wait for the configuration file to download to the switch.
6. Verify the LISL ports are set up correctly.

#### Example of a non-interactive download from a switch with an FID = 8, to FID 10

```
configdownload -fid 8 -sfid 10 -ftp 10.1.2.3,UserFoo,config.txt,password
```

### Example of configDownload on a switch

```
5100:FID128:admin> configdownload -vf
Protocol (scp, ftp, sftp, local) [ftp]:
Server Name or IP Address [host]: 10.1.2.3
User Name [user]: UserFoo
Path/Filename [<home dir>/config.txt]: 5100_FID89.txt
```

\*\*\* CAUTION \*\*\*

This command is used to download the VF configuration to the switch. Afterwards, the switch will be automatically rebooted and the new VF settings will be used. You will then need to run configdownload again to install the configuration(s) for any logical switch(s) that are setup in the new VF configuration.

```
Do you want to continue [y/n]: y
(output truncated)
```

## Restrictions

The following restrictions should be observed when using the **configUpload** or **configDownload** commands when Virtual Fabrics is enabled:

- The **-vf** option is incompatible with the **-fid**, **-sfid**, or **-all** options. Any attempt to combine it with any of the other three will fail the configuration upload or download operation.
- You are not allowed to modify the Virtual Fabrics configuration file after it has been uploaded. Only minimal verification is done by the **configDownload** command to ensure it is compatible, much like the normal downloaded configuration file.
- After the **configDownload -vf** command completes and reboots your switch, you must then download the matching regular configuration using the **configDownload -all** command. This ensures proper behavior of the system and logical switches.
- All of the attributes of the Virtual Fabrics configuration file will be downloaded to the system and take effect. This includes, but is not limited to, logical switch definitions, whether Virtual Fabrics is enabled or disabled, and the F\_Port trunking ports, except the LISL ports. The LISL ports on the system are not affected by the Virtual Fabrics configuration file download.

## Brocade configuration form

Use the form in [Table 45](#) as a hard copy reference for your configuration information.

In the hardware reference manuals for the Brocade DCX and DCX-4S Backbones, there is a guide for FC port setting tables. The tables can be used to record configuration information for the various blades.

**TABLE 45 Brocade configuration and connection**

<b>Brocade configuration settings</b>
IP address
Gateway address
Chassis configuration option
<b>Management connections</b>
Serial cable tag
Ethernet cable tag
<b>Configuration information</b>
Domain ID
Switch name
Ethernet IP address
Ethernet subnet mask
Total number of local devices ( <b>nsShow</b> )
Total number of devices in fabric ( <b>nsAllShow</b> )
Total number of switches in the fabric ( <b>fabricShow</b> )

## 8 Brocade configuration form

# Installing and Maintaining Firmware

---

## In this chapter

- Firmware download process overview . . . . . 191
- Preparing for a firmware download . . . . . 194
- Firmware download on switches . . . . . 196
- Firmware download on a Backbone . . . . . 197
- Firmware download from a USB device . . . . . 201
- FIPS support . . . . . 202
- Test and restore firmware on switches . . . . . 204
- Test and restore firmware on Backbones . . . . . 206
- Validating a firmware download . . . . . 208

## Firmware download process overview

Fabric OS v7.0.1 provides nondisruptive firmware installation.

This chapter refers to the following specific types of blades inserted into the Brocade DCX and DCX 8510 Backbone families:

- FC blades or port blades that contain only Fibre Channel ports; the Brocade FC10-6 and the Brocade FC8-16, FC8-32, FC8-48, and FC8-64.
- AP blades contain extra processors and specialized ports: Brocade FR4-18i, FA4-18, FCOE10-24, and FX8-24.
- CP blades have a control processor (CP) used to control the entire switch; CP blades can be inserted only into slots 6 and 7 on the Brocade DCX or DCX 8510-8, and slots 4 and 5 on the Brocade DCX-4S or DCX 8510-4.
- CORE8 and CR4S-8 core blades provide ICL functionality between two Brocade DCX Backbones. CORE8 blades can be inserted only into slots 5 and 8 on the Brocade DCX. CR4S-8 blades can be inserted only into slots 3 and 6 on the Brocade DCX-4S.
- CORE8 and CR4S-8 core blades provide ICL functionality between two Brocade DCX 8510-8 Backbones. CORE8 blades can be inserted only into slots 5 and 8 on the Brocade DCX. CR4S-8 blades can be inserted only into slots 3 and 6 on the Brocade DCX 8510-4.

---

### NOTE

For more information on troubleshooting a firmware download, refer to the *Fabric OS Troubleshooting and Diagnostics Guide*.

---

You can download Fabric OS to a Backbone, which is a chassis; and to a nonchassis-based system, also referred to as a fixed-port switch. The difference in the download process is that Backbones have two CPs and fixed-port switches have one CP. Use the **firmwareDownload** command to download the firmware from either an FTP or SSH server by using either the FTP, SFTP, or SCP protocol to the switch. Or you can use a Brocade-branded USB device.

The new firmware consists of multiple files in the form of RPM packages listed in a *.plist* file. The *.plist* file contains specific firmware information (time stamp, platform code, version, and so forth) and the names of packages of the firmware to be downloaded. These packages are made available periodically to add features or to remedy defects. Contact your switch support provider to obtain information about available firmware versions.

All systems maintain two partitions of nonvolatile storage areas, a primary and a secondary, to store two firmware images. The firmware download process always loads the new image into the secondary partition. It then swaps the secondary partition to be the primary and high availability (HA) reboots (which is non-disruptive) the system. After the system boots up, the new firmware is activated. The firmware download process then copies the new image from the primary partition to the secondary partition.

---

### ATTENTION

The Brocade 8000 does not support a non-disruptive firmwareDownload. The switch reboots once the firmware upgrade or downgrade is complete.

---

In dual-CP systems, the firmware download process, by default, sequentially upgrades the firmware image on both CPs using HA failover to prevent disruption to traffic flowing through the Backbone. This operation depends on HA status on the Backbone. If the platform does not support HA, you can still upgrade the CPs one at a time.

**If you are using a Brocade DCX or DCX 8510 Backbone family platform, with one or more AP blades:** The Fabric OS automatically detects mismatches between the active CP firmware and the blade's firmware and triggers the auto-leveling process. This auto-leveling process automatically updates the blade firmware to match the active CP. At the end of the auto-leveling process, the active CP and the blade run the same version of the firmware.

If the firmware download process is interrupted by an unexpected reboot, the system automatically repairs and recovers the secondary partition. You must wait for the recovery to complete before issuing another **firmwareDownload** command.

The command supports both non-interactive and interactive modes. If the **firmwareDownload** command is issued without any operands, or if there is any syntax error in the parameters, the command enters an interactive mode, in which you are prompted for input

---

### ATTENTION

For each switch in your fabric, complete all firmware download changes on the current switch before issuing the **firmwareDownload** command on the next switch. This process ensures nondisruption of traffic between switches in your fabric.

To verify the firmwareDownload process is complete, enter the **firmwareDownloadStatus** command on the switch, verify the process is complete, then move on to the next switch.

---

## Upgrading and downgrading firmware

*Upgrading* means installing a newer version of firmware. *Downgrading* means installing an older version of firmware.

In most cases, you will be *upgrading* firmware; that is, installing a newer firmware version than the one you are currently running. However, some circumstances may require installing an older version; that is, *downgrading* the firmware. The procedures in this section assume that you are upgrading firmware, but they work for downgrading as well, provided the old and new firmware versions are compatible. Always reference the latest release notes for updates that may exist regarding downgrades under particular circumstances.

For details on Administrative Domains and the firmware download process, see [Chapter 17, “Managing Administrative Domains”](#) for more information.

For details about testing and restoring firmware, see [“Test and restore firmware on Backbones”](#) on page 206.

### *Password-less firmware download*

You can download firmware without a password using the **sshutil** command for public key authentication when SSH is selected. The switch has to be configured to install the private key, and the you must export the public key to the remote host. Before running the **firmwareDownload** command, you must first configure the SSH protocol to permit passwordless logins for outgoing authentication as described in [“Configuring outgoing SSH authentication”](#) on page 119

## Considerations for FICON CUP environments

To prevent channel errors during nondisruptive firmware installation, the switch CUP port must be taken offline from all host systems.

## HA sync state

High availability (HA) synchronization occurs when two CPs in a Backbone are synchronized. This state provides redundancy and a non-disruptive firmware download. In order for a firmware download to successfully occur, the two CPs in a Backbone must be in sync.

If the CPs have mixed versions when you enter the **firmwareDownload** command, the CPs may not be in HA sync. In this case, you need to enter the **firmwareDownload -s** command first to upgrade or downgrade the standby CP to the same level as the active CP first, and then upgrade the CPs to the desired version of firmware.

---

### NOTE

Do not run mixed firmware levels on CPs.

---

[Table 46](#) shows the sync state of a Backbone that has different Fabric OS versions installed on the active and standby CP. Use the table to determine if you need to use the **firmwareDownload -s** command.

**TABLE 46** Backbone HA sync states

Active CP Fabric OS version	Standby CP Fabric OS version	HA sync state	Remedy
v6.2.0	v6.2.0	inSync	n/a
v6.2.x	v6.3.0	inSync	n/a
v6.3.0	v6.2.x	If Ethernet Switch Service is enabled, no sync.	Run <b>firmwareDownload -s</b> on the standby CP and upgrade it to v6.3.0.

TABLE 46 Backbone HA sync states (Continued)

Active CP Fabric OS version	Standby CP Fabric OS version	HA sync state	Remedy
v6.3.0	v6.3.0	inSync	n/a
v6.3.0	v6.4.0	inSync	n/a
v6.4.0	v6.3.0	inSync	Run <b>firmwareDownload -s</b> on the standby CP and upgrade it to v6.4.0.
v6.4.0	v6.4.0	inSync	n/a
v7.0.0	v6.4.0	inSync	Run <b>firmwareDownload -s</b> on the standby CP to upgrade it to v7.0.0
v7.0.0	v7.0.0	inSync	n/a

## Preparing for a firmware download

Before executing a firmware download, it is recommended that you perform the tasks listed in this section. In the unlikely event of a failure or time-out, these preparation tasks enable you to provide your switch support provider the information required to perform advanced troubleshooting.

It is recommended that you perform a **configUpload** to back up the current configuration before you download firmware to a switch. See [“Configuration file backup”](#) on page 180 for details.

1. Read the release notes for the new firmware to find out if there are any updates related to the firmware download process.
2. Connect to the switch and log in using an account with admin permissions. Enter the **firmwareShow** command to verify the current version of Fabric OS.

Brocade does not support upgrades from more than one previous release. For example, upgrading from Fabric OS v6.3.0 to v6.4.0 is supported, but upgrading from Fabric OS v6.2.0 or a previous release directly to v7.0.0 is not. In other words, upgrading a switch from Fabric OS v6.3.0 to v7.0.0 is a two-step process—first upgrade to v6.4.0, and then upgrade to v7.0.0. If you are running a pre-Fabric OS v6.2.0 version you must upgrade to v6.2.0, then to v6.3.0, then to v6.4.0, and finally to v7.0.0.

3. Perform a **configUpload** prior to the **firmwareDownload**. Save the config file on your FTP or SSH server or USB memory device on supported platforms.
4. *Optional:* For additional support, connect the switch to a computer with a serial console cable. Ensure that all serial consoles (both CPs for Backbones) and any open network connection sessions, such as Telnet, are logged and included with any trouble reports.
5. Connect to the switch and log in to the switch using an account with admin permissions. Enter the **supportSave** command to retrieve all current core files prior to executing the firmware download. This helps to troubleshoot the firmware download process if a problem is encountered.
6. *Optional:* Enter the **errClear** command to erase all existing messages in addition to internal messages.



## Connected switches

Before you upgrade the firmware on your switch, you need to check the connected switches to ensure compatibility and that any older versions are supported. Refer to the Fabric OS Compatibility section of the *Brocade Fabric OS Release Notes*, for the recommended firmware version.

---

### NOTE

Go to <http://www.brocade.com> to view end-of-life policies for Brocade products. Navigate to the **Support** tab, then select **Policies and Locations**. Under **Important Note**, click on **End of Life Support**. End-of-life products are not supported.

---

If fixed-port switches are adjacent and you start firmware downloads on them at the same time, there may be traffic disruption.

To determine if you need to upgrade switches connected to the switch you are upgrading, use the following procedure on each connected switch to display firmware information and build dates

## Finding the switch firmware version

1. Connect to the switch and log in using an account with admin permissions.
2. Enter the **version** command.

The following information is displayed:

- **Kernel** displays the version of switch kernel operating system.
- **Fabric OS** displays the version of switch Fabric OS.
- **Made on** displays the build date of firmware running in switch.
- **Flash** displays the install date of firmware stored in nonvolatile memory.
- **BootProm** displays the version of the firmware stored in the boot PROM.

## Obtain and decompress firmware

Firmware upgrades are available for customers with support service contracts and for partners on the Brocade website at <http://www.brocade.com>.

At the Brocade website click *Brocade Connect*, log in, and follow the instructions to register and download firmware. Partners with authorized accounts can use the *Brocade Partner Network*.

You must decompress the firmware *before* you can use the **firmwareDownload** command to update the firmware on your equipment. Use the UNIX tar command for .tar files, the gunzip command for all .gz files, or a Windows unzip program for all .zip files

When you unpack the downloaded firmware, it expands into a directory that is named according to the version of Fabric OS it contains. For example, when you download and unzip v7.0.0.zip, it expands into a directory called v7.0.0. When you issue the **firmwareDownload** command, there is an automatic search for the correct package file type associated with the switch. Specify only the path up to and including the v7.0.0 directory.

## Firmware download on switches

Brocade fixed-port switches maintain primary and secondary partitions for firmware. The **firmwareDownload** command defaults to an autocommit option that automatically copies the firmware from one partition to the other.

---

### NOTE

This section only applies when upgrading from Fabric OS v6.1.x to v6.2.0, or from different versions of v6.2.0, such as patch releases. If you are downgrading from v6.2.0 to v6.1.x, you must enter the **firmwareDownload -s** command as described in [“Test and restore firmware on switches”](#) on page 204.

This is not necessary when downgrading from Fabric OS v6.3.0 to v6.2.0 or from Fabric OS v6.4.0 to v6.3.0.

Do not override autocommit under normal circumstances; use the default. See [“Test and restore firmware on Backbones”](#) on page 206 for details about overriding the autocommit option.

## Switch firmware download process overview

The following list describes the default behavior after you enter the **firmwareDownload** command (without options) on Brocade fixed-port switches:

- The Fabric OS downloads the firmware to the secondary partition.
- The system performs a high-availability reboot (**haReboot**). After the **haReboot**, the former secondary partition is the primary partition.
- The system replicates the firmware from the primary to the secondary partition.

The upgrade process first downloads and then commits the firmware to the switch. While the upgrade is proceeding, you can start a session on the switch and use the **firmwareDownloadStatus** command to observe the upgrade progress if you wish.



### CAUTION

After you start the process, do not enter any disruptive commands (such as **reboot**) that interrupt the process. The entire firmware download and commit process takes approximately 17 minutes.

If there is a problem, wait for the time-out (30 minutes for network problems) before issuing the **firmwareDownload** command again. Disrupting the process can render the switch inoperable and require you to seek help from your switch service provider.

Do not disconnect the switch from power during the process. The switch could be inoperable when rebooted.

## *Upgrading firmware for Brocade fixed-port switches*

1. Take the following appropriate action based on what service you are using:
  - If you are using FTP, SFTP, or SCP, verify that the FTP or SSH server is running on the host server and that you have a valid user ID and password on that server.
  - If your platform supports a USB memory device, verify that it is connected and running.

2. Obtain the firmware file from the Brocade website at <http://www.brocade.com> and store the file on the FTP or SSH server or the USB memory device.
3. Unpack the compressed files preserving directory structures.  
The firmware is in the form of RPM packages with names defined in a *.plist* file. The *.plist* file contains specific firmware information and the names of packages of the firmware to be downloaded.
4. Connect to the switch and log in using an account with admin permissions.
5. Issue the **firmwareShow** command to check the current firmware version on connected switches. Upgrade their firmware if necessary before proceeding with upgrading this switch.  
See “[Connected switches](#)” on page 195 for details.
6. Enter the **firmwareDownload** command and respond to the prompts.

**NOTE**

If DNS is enabled and a server name instead of a server IP address is specified in the command line, **firmwareDownload** determines whether IPv4 or IPv6 should be used.

To be able to mention the FTP server by name, you must enter at least one DNS server using the **dnsConfig** command.

7. At the “Do you want to continue [y/n]” prompt, enter **y**.
8. After the HA reboot, connect to the switch and log in again using an account with admin permissions.
9. Enter the **firmwareDownloadStatus** command to determine if the firmware download process has completed.
10. After the firmware commit is completed, which takes several minutes, enter the **firmwareShow** command to verify the firmware level of both partitions is the same.

**Example of an interactive firmware download**

```
switch:root> firmwaredownload
Server Name or IP Address: 10.31.2.25
User Name: releaseuser
File Name: /home/SAN/fos/v7.0.1/v7.0.1
Network Protocol(1-auto-select, 2-FTP, 3-SCP, 4-SFTP) [1]: 4
Verifying if the public key authentication is available.Please wait ...
The public key authentication is not available.
Password:
Server IP: 10.31.2.25, Protocol IPv4
Checking system settings for firmwaredownload...
```

## Firmware download on a Backbone

You can download firmware to a Backbone without disrupting the overall fabric if the two CP blades are installed and fully synchronized. Use the **haShow** command to verify that the CPs are synchronized prior to beginning the firmware download process. If only one CP blade is inserted, powered on, or plugged into the network, you can run **firmwareDownload -s** to upgrade the CP. If

the CPs are not in sync, you can run **firmwareDownload -s** on each of the CPs to upgrade them. These operations are disruptive. Or if the CPs are not in sync, run the **haSyncStart** command. If the problem persists, refer to the *Fabric OS Troubleshooting and Diagnostics Guide*. If the troubleshooting information fails to help resolve the issue, contact your switch service provider.

During the upgrade process, the Backbone fails over to its standby CP blade and the IP address for the Backbone moves to that CP blade's Ethernet port. This may cause informational ARP address reassignment messages to appear on other switches in the fabric. This is normal behavior, because the association between the IP addresses and MAC addresses has changed.

---

### ATTENTION

To successfully download firmware, you must have an active Ethernet connection on each CP.

---

## Backbone firmware download process overview

The following summary describes the default behavior of the **firmwareDownload** command (without options) on a Backbone. After you enter the **firmwareDownload** command on the active CP blade the following actions occur:

1. The standby CP blade downloads firmware.
2. The standby CP blade reboots and comes up with the new Fabric OS.
3. The active CP blade synchronizes its state with the standby CP blade.
4. The active CP blade forces a failover and reboots to become the standby CP blade.
5. The new active CP blade synchronizes its state with the new standby CP blade.
6. The *new* standby CP blade (the active CP blade before the failover) downloads firmware.
7. The *new* standby CP blade reboots and comes up with the new Fabric OS.
8. The new active CP blade synchronizes its state with the new standby CP blade.
9. The **firmwareCommit** command runs automatically on both CP blades.



### CAUTION

After you start the process, do not enter any disruptive commands (such as **reboot**) that interrupt the process. The entire firmware download and commit process takes approximately 17 minutes.

If there is a problem, wait for the time-out (30 minutes for network problems) before issuing the **firmwareDownload** command again. Disrupting the process can render the switch inoperable and require you to seek help from your switch service provider.

Do not disconnect the switch from power during the process . The switch could be inoperable when rebooted.

---

## *Upgrading firmware on Backbones (including blades)*

There is only one chassis management IP address for the Brocade Backbones.

---

### NOTE

By default, the **firmwareDownload** command automatically upgrades both the active and the standby CP and all co-CPs on the CP blades in the Brocade Backbones. It automatically upgrades all AP blades in the Brocade Backbones using auto-leveling.

---

1. Verify that the Ethernet interfaces located on CP0 and CP1 are plugged into your network.
2. Verify that the FTP, SFTP, or SSH server is running on the host server and that you have a user ID on that server.
3. Obtain the firmware file from the Brocade website at <http://www.brocade.com> and store the file on the FTP or SSH server.
4. Unpack the compressed files preserving directory structures.

The firmware is in the form of RPM packages with names defined in a *.plist* file. The *.plist* file contains specific firmware information and the names of packages of the firmware to be downloaded.

5. Connect to the chassis IP management interface or active CP and log in as admin.
6. Use the **firmwareShow** command to check the current firmware version on connected switches. Upgrade the firmware, if necessary, before proceeding with upgrading this switch.

See “[Connected switches](#)” on page 195.

7. Enter the **haShow** command to confirm that the two CP blades are synchronized.

In the following example, the active CP blade is CP0 and the standby CP blade is CP1:

```
ecp:admin> hashow
Local CP (Slot 5, CP0): Active, Warm Recovered
Remote CP (Slot 6, CP1): Standby, Healthy
HA enabled, Heartbeat Up, HA State synchronized
```

CP blades must be synchronized and running Fabric OS v6.0.0 or later to provide a nondisruptive download. If the two CP blades are not synchronized, enter the **haSyncStart** command to synchronize them. If the CPs still are not synchronized, contact your switch service provider.

For further troubleshooting, refer to the *Fabric OS Troubleshooting and Diagnostics Guide*.

8. Enter the **firmwareDownload** command and respond to the interactive prompts.
9. At the “Do you want to continue [y/n]” prompt, enter **y**.

The firmware is downloaded to one CP blade at a time, beginning with the standby CP blade. During the process, the active CP blade fails over. After the firmware is downloaded, a firmware commit starts on both CP blades. The entire firmware download and commit process takes approximately 17 minutes.

**If an AP blade is present:** At the point of the failover an *autoleveling* process is activated. Autoleveling is triggered when the active CP detects a blade that contains a different version of the firmware, regardless of which version is older. Autoleveling downloads firmware to the AP blade, swaps partitions, reboots the blade, and copies the new firmware from the primary partition to the secondary partition. If you have multiple AP blades, they are updated simultaneously; however, the downloads can occur at different rates.

Autoleveling takes place in parallel with the firmware download being performed on the CPs, but does not impact performance. Fibre Channel traffic is not disrupted during autoleveling, but GbE traffic on AP blades may be affected.

```
ecp:admin> firmwaredownload
Type of Firmware (FOS, SAS, or any application) [FOS]:
Server Name or IP Address: 10.1.2.3
User Name: userfoo
File Name: /home/userfoo/v7.0.0
Network Protocol (1-auto-select, 2-FTP, 3-SCP, 4-SFTP) [1]:
Password: <hidden>
```

```
Checking version compatibility...
Version compatibility check passed.
```

The following AP blades are installed in the system.

Slot Name	Versions	Traffic Disrupted
4	FR4-18i v7.0.0	None
10	FR4-18i v7.0.0	None

This command will upgrade the firmware on both CPs and all AP blade(s) above. If you want to upgrade firmware on a single CP only, please use `-s` option. You may run `firmwaredownloadstatus` to get the status of this" command.

This command will cause a warm/non-disruptive boot on the active CP, but will require that existing telnet, secure telnet or SSH sessions be restarted.

```
Do you want to continue [Y]: y
```

```
The firmware is being downloaded to the Standby CP. It may take up to 10
minutes
```

10. Optionally, after the failover, connect to the switch, and log in again as admin. Using a separate session to connect to the switch, enter the `firmwareDownloadStatus` command to monitor the firmware download status.

```
sw0:FID128:admin> firmwaredownloadstatus
[1]: Mon Mar 22 04:27:21 2010
Slot 7 (CP1, active): Firmware is being downloaded to the switch. This step
may take up to 30 minutes.

[2]: Mon Mar 22 04:34:58 2010
Slot 7 (CP1, active): Relocating an internal firmware image on the CP blade.

[3]: Mon Mar 22 04:35:29 2010
Slot 7 (CP1, active): The internal firmware image is relocated successfully.

[4]: Mon Mar 22 04:35:30 2010
```

```
Slot 7 (CP1, active): Firmware has been downloaded to the secondary partition
of the switch.
```

```
[5]: Mon Mar 22 04:37:24 2010
Slot 7 (CP1, standby): The firmware commit operation has started. This may
take up to 10 minutes.
```

```
[6]: Mon Mar 22 04:41:59 2010
Slot 7 (CP1, standby): The commit operation has completed successfully.
```

```
[7]: Mon Mar 22 04:41:59 2010
Slot 7 (CP1, standby): Firmwaredownload command has completed successfully.
Use firmwareshow to verify the firmware versions.
```

11. Enter the **firmwareShow** command to display the new firmware versions.

## Firmware download from a USB device

The Brocade 300, 5100, 5300, 6505, 6510, 7800, 8000, and VA-40FC switches and the Brocade DCX, DCX-4S, or DCX 8510 Backbones support a firmware download from a Brocade branded USB device attached to the switch or active CP. Before the USB device can be accessed by the **firmwareDownload** command, it must be enabled and mounted as a file system. The firmware images to be downloaded must be stored under the relative path from `/usb/usbstorage/brocade/firmware` or use the absolute path in the USB file system. Multiple images can be stored under this directory. There is a `firmwarekey` directory where the public key signed firmware is stored.

When the **firmwareDownload** command line option, `-u` (upper case), is specified, the **firmwareDownload** command downloads the specified firmware image from the USB device. When specifying a path to a firmware image in the USB device, you can only specify the relative path to `/firmware` or the absolute path.

### Enabling USB

1. Log in to the switch using an account assigned to the admin role.
2. Enter the **usbStorage -e** command.

### Viewing the USB file system

1. Log in to the switch using an account assigned to the admin role.
2. Enter the **usbStorage -l** command.

```
BrcdDCXBB:admin> usbstorage -l
firmware\                381MB    2010 Mar 28 15:33
  v7.0.0\                 381MB    2010 Mar 28 10:39
config\                  0B       2010 Mar 28 15:33
support\                 0B       2010 Mar 28 15:33
firmwarekey\             0B       2010 Mar 28 15:33
Available space on usbstorage 79%
```

## Downloading from USB using the relative path

1. Log in to the switch as admin.
2. Enter the **firmwareDownload -U** command.

```
ecp:admin>firmwaredownload -U v7.0.0
```

## Downloading from USB using the absolute path

1. Log in to the switch as admin.
2. Enter the **firmwareDownload** command with the -U operand.

```
ecp:admin>firmwaredownload -U /usb/usbstorage/brocade/firmware/v7.0.0
```

## FIPS support

Federal information processing standards (FIPS) specify the security standards needed to satisfy a cryptographic module utilized within a security system for protecting sensitive information in the computer and telecommunication systems. For more information about FIPS, refer to [Chapter 7, “Configuring Security Policies”](#).

Fabric OS v7.0.0 firmware is digitally signed using the OpenSSL utility to provide FIPS support. To use the digitally signed software, you must configure the switch to enable Signed Firmwaredownload. If it is not enabled, the firmware download process ignores the firmware signature and performs as before.

If Signed Firmwaredownload is enabled, and if the validation succeeds, the firmware download process proceeds normally. If the firmware is not signed or if the signature validation fails, **firmwareDownload** fails.

To enable or disable FIPS, refer to [Chapter 7, “Configuring Security Policies”](#).

## Public and private key management

For signed firmware, Brocade uses RSA with 1024-bit length key pairs, a private key and a public key. The private key is used to sign the firmware files when the firmware is generated. The public key is packaged in an RPM-package as part of the firmware, and is downloaded to the switch. After it is downloaded, it can be used to validate the firmware to be downloaded next time when you run the **firmwareDownload** command.

The public key file on the switch contains only one public key. It is only able to validate firmware signed using one corresponding private key. If the private key changes in future releases, you need to change the public key on the switch by one of the following methods:

- By using the **firmwareDownload** command. When a new firmware is downloaded, firmwareDownload always replaces the public key file on the switch with what is in the new firmware. This allows you to have planned firmware key changes.
- By using the **firmwareKeyUpdate** command. This command retrieves a specified public key file from a specific server location and replaces the one on the switch. So for easy access, the information regarding firmware versions and their corresponding public key files is documented in the release notes or stored in a known location in the Brocade website. This command allows the customer to handle unplanned firmware key changes.



**NOTE**

If FIPS is enabled, all logins should be done through SSH or direct serial and the transfer protocol should be SCP.

***Updating the firmware key***

1. Log in to the switch as admin.
2. Type the **firmwareKeyUpdate** command and respond to the prompts.

**The firmwareDownload command**

As mentioned previously, the public key file needs to be packaged, installed, and run on your switch before downloading a signed firmware.

When firmwareDownload installs a firmware file, it needs to validate the signature of the file. Different scenarios are handled as follows:

- If a firmware file does not have a signature, how it is handled depends on the “signed\_firmware” parameter on the switch. If it is enabled, firmwareDownload fails. Otherwise, firmwareDownload displays a warning message and proceeds normally. So when downgrading to a non-FIPS compliant firmware, the “signed\_firmware” flag needs to be disabled.
- If the firmware file has a signature but the validation fails, firmwareDownload fails. This means the firmware is not from Brocade, or the contents have been modified.
- If the firmware file has a signature and the validation succeeds, firmwareDownload proceeds normally.

SAS, DMM, and third party application images are not signed.

***Configuring the switch for signed firmware***

1. Connect to the switch and log in using an account with admin permissions.
2. Type the **configure** command.
3. Respond to the prompts as follows:

<i>System Service</i>	Default is no; press Enter to select default setting.
<i>ssl attributes</i>	Default is no; press Enter to select default setting.
<i>snmp attributes</i>	Default is no; press Enter to select default setting.
<i>rpcd attributes</i>	Default is no; press Enter to select default setting.
<i>cfgload attributes</i>	<b>Select Yes.</b> The following questions are displayed:
	<b>Enforce secure config Upload/Download:</b> Select yes
	<b>Enforce signed firmware download:</b> Select yes
<i>Webtools attributes</i>	Default is no; press Enter to select default setting.
<i>System</i>	Default is no; press Enter to select default setting.

## Power-on firmware checksum test

FIPS requires the checksums of the executables and libraries on the filesystem to be validated before Fabric OS modules are launched. This is to make sure these files have not been changed after they are installed.

When firmware RPM packages are installed during `firmwareDownload`, the MD5 checksums of the firmware files are stored in the RPM database on the filesystem. The checksums go through all of the files in the RPM database. Every file compares its current checksum with the checksum that is in the RPM database. If they are different, the command displays an output message informing you of the difference.

Because the validation may take up to a few minutes, it is not performed during a hot code load. It is only performed after a cold reboot of the switch.

For more information on FIPS, see [Chapter 7, “Configuring Security Policies”](#).

## Test and restore firmware on switches

---

### NOTE

This section does not apply to SAS or storage applications applied to the FA4-18 AP blade.

---

Typically, users downgrade firmware after briefly evaluating a newer (or older) version and then restore the original version of the firmware. Testing a new version of firmware in this manner ensures that you do not replace existing firmware because the evaluated version occupies only one partition on the switch.

---

### ATTENTION

When you evaluate new firmware, make sure you disabled all features that are not supported by the original firmware before restoring to the original version.

---

## Testing a different firmware version on a switch

1. Verify that the FTP, SFTP, or SSH server is running on the host server and that you have a user ID on that server.
2. Obtain the firmware file from the Brocade website at <http://www.brocade.com> or switch support provider and store the file on the FTP or SSH server.
3. Unpack the compressed files preserving directory structures.  
The firmware is in the form of RPM packages with names defined in a `.plist` file, that contains specific firmware information and the names of packages of the firmware to be downloaded.
4. Connect to the switch and log in using an account with admin permissions.
5. Enter the `firmwareShow` command to view the current firmware.
6. Enter the `firmwareDownload -s` command to update the firmware and respond to the prompts.

### Example of a `firmwareDownload` to a single partition

```
ecp:admin> firmwareDownload -s
Type of Firmware (FOS, SAS, or any application) [FOS]:
Server Name or IP Address: 10.1.2.3
Network Protocol (1-auto-select, 2-FTP, 3-SCP, 4-SFTP) [1]:
```

```

User Name: userfoo
File Name: /home/userfoo/v7.0.0
Password: <hidden>
Do Auto-Commit after Reboot [Y]: n
Reboot system after download [N]: y
Firmware is being downloaded to the switch. This step may take up to 30
minutes.
Checking system settings for firmwaredownload...

```

The switch performs a reboot and comes up with the new firmware to be tested. Your current switch session automatically disconnects.

---

#### ATTENTION

Downloading firmware to a switch can be disruptive to switch traffic.

---

7. Connect to the switch, log in as admin, and enter the **firmwareShow** command to confirm that the primary partition of the switch contains the new firmware.

You are now ready to evaluate the new version of firmware.

---

#### ATTENTION

**Stop!** If you want to restore the firmware, stop here and skip ahead to [step 9](#); otherwise, continue to [step 8](#) to commit the firmware on the switch, which completes the firmware download operations.

---

8. Commit the firmware.
  - a. Enter the **firmwareCommit** command to update the secondary partition with new firmware. Note that it takes several minutes to complete the commit operation.
  - b. Enter the **firmwareShow** command to confirm both partitions on the switch contain the new firmware.

---

#### ATTENTION

**Stop!** If you have completed [step 8](#), then you have committed the firmware on the switch and you have completed the firmware download procedure.

---

9. Restore the firmware.
  - a. Enter the **firmwareRestore** command. The switch reboots and comes up with the original firmware again.
 

A **firmwareCommit** automatically begins to copy the original firmware from the primary partition to the secondary partition. At the end of the firmware commit process, both partitions have the original firmware. Note that it takes several minutes to complete the commit operation.
  - b. Wait five minutes to ensure that all processes have completed and the switch is fully up and operational.
  - c. Log in to the switch. Enter the **firmwareShow** command and verify that both partitions on the switch have the original firmware.

## Test and restore firmware on Backbones

This procedure enables you to perform a firmware download on each CP and verify that the procedure was successful before committing to the new firmware. The old firmware is saved in the secondary partition of each CP until you enter the **firmwareCommit** command. If you decide to back out of the installation prior to the **firmwareCommit**, you can enter the **firmwareRestore** command to restore the former active Fabric OS firmware image.

The **firmwareRestore** command can only run if autocommit was disabled during the **firmwareDownload**. This command cannot be used to restore SAS and SA images.

---

### NOTE

Brocade recommends that, under normal operating conditions, you maintain the same firmware version on both CPs, and on both partitions of each CP. This procedure enables you to evaluate firmware before you commit. As a standard practice, do not run mixed firmware levels on CPs.

---

### Testing different firmware versions on Backbones

1. Connect to the Brocade Backbone IP address.
2. Enter the **ipAddrShow** command and note the address of CP0 and CP1.
3. Enter the **haShow** command and note which CP is active and which CP is standby. Verify that both CPs are in sync.
4. Enter the **firmwareShow** command and confirm that the current firmware on both partitions on both CPs is listed as expected.
5. Exit the session.
6. Update the firmware on the standby CP.
  - a. Connect to the Backbone and log in as admin to the standby CP.
  - b. Enter the **firmwareDownload -s** command and respond to the prompts.  
  
At this point, the firmware downloads to the standby CP only. When it has completed the download to that CP, reboot it. The current Backbone session is disconnected.
7. Fail over to the standby CP.
  - a. Connect to the Backbone on the active CP.
  - b. Enter the **haShow** command to verify that HA synchronization is complete. It takes a minute or two for the standby CP to reboot and synchronize with the active CP.



### CAUTION

If you are downgrading from Fabric OS v6.2.0 to v6.1.0, your CPs do not gain synchronization, as this is a disruptive firmware download. Refer to [Table 46](#) on page 193 for more information on synchronization states.

- c. Enter the **firmwareShow** command to confirm that the primary partition of the standby CP contains the new firmware.
- d. Enter the **haFailover** command. The active CP reboots and the current Backbone session is disconnected.

**If an AP blade is present:** At the point of the failover an *autoleveling* process is activated. See “[Backbone firmware download process overview](#)” on page 198 for details about autoleveling.

8. Verify the failover.
  - a. Connect to the Backbone on the active CP, which is the former standby CP.
  - b. Enter the **haShow** command to verify that the HA synchronization is complete. It takes a minute or two for the standby CP, which is the old active CP, to reboot and synchronize with the active CP.

---

#### NOTE

If the CPs fail to synchronize, you can still proceed because the version being tested is already present on the active CP, and subsequent steps ensures that the standby CP is updated to the same version as the active CP.

---

- c. Confirm the evaluation version of firmware is now running on the active CP by entering the **firmwareShow** command.
9. Update firmware on the standby CP.
  - a. Connect to the Backbone on the standby CP, which is the old active CP.
  - b. Enter the **firmwareDownload** command with the **-s -b -n** operands. This ensures that the following steps are successful.
 

At this point the firmware downloads to the standby CP only and reboots it. The current Backbone session is disconnected.
  - c. Wait one minute for the standby CP to reboot, and then connect to the Backbone and log in as admin.
  - d. Enter the **firmwareShow** command to confirm that *both* primary partitions now have the test drive firmware in place.
 

You are now ready to evaluate the new version of firmware.

---

#### ATTENTION

**Stop!** If you want to *restore* the firmware, stop here and skip ahead to [step 12](#); otherwise, continue to [step 10](#) to commit the firmware on both CPs, which completes the firmware download.

---

10. Perform a commit on the standby CP.
 

From the current Backbone session on the standby CP, enter the **firmwareCommit** command to update the secondary partition with new firmware. It takes several minutes to complete the commit operation. Do not do anything on the Backbone while this operation is in process.
11. Perform a commit on the active CP.
  - a. From the current Backbone session on the active CP, enter the **firmwareShow** command and confirm that only the active CP secondary partition contains the old firmware.
  - b. Enter the **firmwareCommit** command to update the secondary partition with the new firmware. It takes several minutes to complete the commit operation. Do not do anything on the Backbone while this operation is in process.
  - c. Upon completion of the **firmwareCommit** command, type the **firmwareShow** command to confirm both partitions on both CPs contain the new firmware.

- d. Enter the **haShow** command to confirm that the HA state is in sync.

---

**ATTENTION**

**Stop!** If you have completed [step 11](#), then you have committed the firmware on both CPs and you have completed the firmware download procedure.

---

12. Restore the firmware on the standby CP.

In the current Backbone session for the standby CP, enter the **firmwareRestore** command. The standby CP reboots and the current Backbone session ends. Both partitions have the same Fabric OS after several minutes.

13. Perform **haFailover** on the active CP.

- a. In the current Backbone session for the active CP, enter the **haShow** command to verify that HA synchronization is complete. It takes a minute or two for the standby CP to reboot and synchronize with the active CP.
- b. Enter the **haFailover** command. The active CP reboots and the current Backbone session ends. The Backbone is now running the original firmware.

14. Restore firmware on the “new” standby CP.

- a. Wait one minute and connect to the Backbone on the new standby CP, which is the old active CP.
- b. Enter the **firmwareRestore** command. The standby CP reboots and the current Backbone session ends. Both partitions have the same Fabric OS after several minutes.
- c. Wait five minutes and log in to the Backbone. Enter the **firmwareShow** command and verify that all partitions have the original firmware.

**If an AP blade is present:** Blade partitions always contain the same version of the firmware on both partitions (it does not keep two copies). The firmware is stored on the blade’s compact flash card and is always synchronized with the active CP’s firmware. Thus, if you restore the active CP firmware, the blade firmware is automatically downloaded (auto-leveled) to become consistent with the new CP firmware (the blade firmware is basically restored).

Your system is now restored to the original partitions on both CPs. Make sure that servers using the fabric can access their storage devices.

If you want to upgrade a Backbone with only one CP in it, follow the procedures in [“Test and restore firmware on switches”](#) on page 204. Note, however, that upgrading a Backbone with only one CP is disruptive to switch traffic.

## Validating a firmware download

Validate the firmware download by running the following commands: **firmwareShow**, **firmwareDownloadStatus**, **nsShow**, **nsAllShow**, and **fabricShow**.

**NOTE**

When you prepared for the firmware download earlier, you issued either the **supportShow** or **supportSave** command. Although you can issue the command again and compare the output from before and after, it may take up to 30 minutes for the command to execute. To save time, it is recommended that you use the commands listed below, which are all subsets of the **supportSave** output.

All of the connected servers, storage, and switches should be present in the output of these commands. If there is a discrepancy, it is possible that a device or switch cannot connect to the fabric and further troubleshooting is necessary.

**firmwareShow** Displays the current firmware level on the switch. For Brocade Backbones, this command displays the firmware loaded on both partitions (primary and secondary) for both CPs and AP blades. Brocade recommends that you maintain the same firmware level on both partitions of each CP within the Brocade Backbone. The **firmwareShow** command displays the firmware version on the CPs.

```
ecp:admin> firmwreshow
```

Slot Name	Appl	Primary/Secondary Versions	Status
6 CP0	FOS	v7.0.0 v7.0.0	ACTIVE *
7 CP1	FOS	v7.0.0 v7.0.0	STANDBY
* Local CP			

**firmwareDownloadStatus** Displays an event log that records the progress and status of events during Fabric OS, SAS, and SA firmwareDownload. The event log is created by the current **firmwareDownload** command and is kept until another **firmwareDownload** command is issued. There is a timestamp associated with each event. When downloading SAS or SA in systems with two control processor (CP) cards, you can only run this command on the active CP. When downloading Fabric OS, the event logs in the two CPs are synchronized. This command can be run from either CP.

**nsShow** Displays all devices directly connected to the switch that have logged into the name server. Make sure the number of attached devices after the firmware download is exactly the same as the number of attached devices prior to the firmware download.

**nsAllShow** Displays all devices connected to a fabric. Make sure the number of attached devices after the firmware download is exactly the same as the number of attached devices prior to the firmware download.

**fabricShow** Displays all switches in a fabric. Make sure the number of switches in the fabric after the firmware download is exactly the same as the number of attached devices prior to the firmware download.

## 9 Validating a firmware download



# Managing Virtual Fabrics

---

## In this chapter

• Virtual Fabrics overview .....	211
• Logical switch overview .....	212
• Logical fabric overview .....	216
• Management model for logical switches .....	221
• Account management and Virtual Fabrics .....	221
• Supported platforms for Virtual Fabrics .....	222
• Limitations and restrictions of Virtual Fabrics .....	224
• Enabling Virtual Fabrics mode .....	225
• Disabling Virtual Fabrics mode .....	226
• Configuring logical switches to use basic configuration values .....	227
• Creating a logical switch or base switch .....	227
• Executing a command in a different logical switch context .....	229
• Deleting a logical switch .....	230
• Adding and moving ports on a logical switch .....	230
• Displaying logical switch configuration .....	231
• Changing the fabric ID of a logical switch .....	232
• Changing a logical switch to a base switch .....	232
• Setting up IP addresses for a Virtual Fabric .....	234
• Removing an IP address for a Virtual Fabric .....	234
• Configuring a logical switch to use XISLs .....	234
• Changing the context to a different logical fabric .....	235
• Creating a logical fabric using XISLs .....	235

## Virtual Fabrics overview

Virtual Fabrics is an architecture to virtualize hardware boundaries. Traditionally, SAN design and management is done at the granularity of a physical switch. Virtual Fabrics allows SAN design and management to be done at the granularity of a port.

Virtual Fabrics is a suite of related features that can be customized based on your needs. The Virtual Fabrics suite consists of the following specific features:

- Logical switch
- Logical fabric
- Device sharing

This chapter describes the logical switch and logical fabric features. For information about device sharing with Virtual Fabrics, refer to [“FC-FC routing and Virtual Fabrics”](#) on page 501.

For information about supported switches and port types, refer to [“Supported platforms for Virtual Fabrics”](#) on page 222.

Virtual Fabrics and Admin Domains are mutually exclusive and are not supported at the same time on a switch.

---

#### NOTE

A note on terminology: *Virtual Fabrics* is the name of the suite of features. A *logical fabric* is a type of fabric that you can create using the Virtual Fabrics suite of features.

---

## Logical switch overview

Traditionally, each switch and all the ports in the switch act as a single Fibre Channel switch (FC switch) that participates in a single fabric. The logical switch feature allows you to divide a physical chassis into multiple fabric elements. Each of these fabric elements is referred to as a *logical switch*. Each logical switch functions as an independent self-contained FC switch.

---

#### NOTE

Each chassis can have multiple logical switches.

---

### Default logical switch

To use the Virtual Fabrics features, you must first enable Virtual Fabrics on the switch. Enabling Virtual Fabrics creates a single logical switch in the physical chassis. This logical switch is called the *default logical switch*, and it initially contains all of the ports in the physical chassis.

[Figure 17](#) shows a switch before and after enabling Virtual Fabrics. In this example, the switch has 10 ports, labeled P0 through P9.

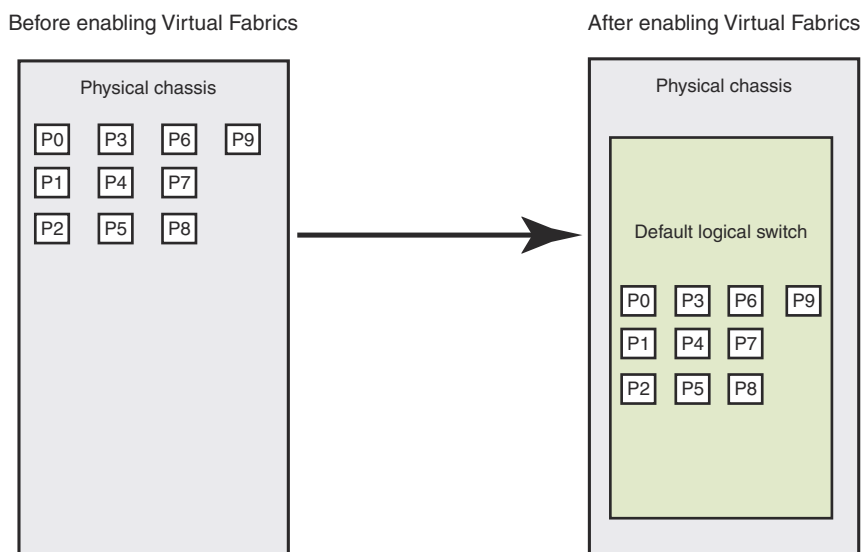
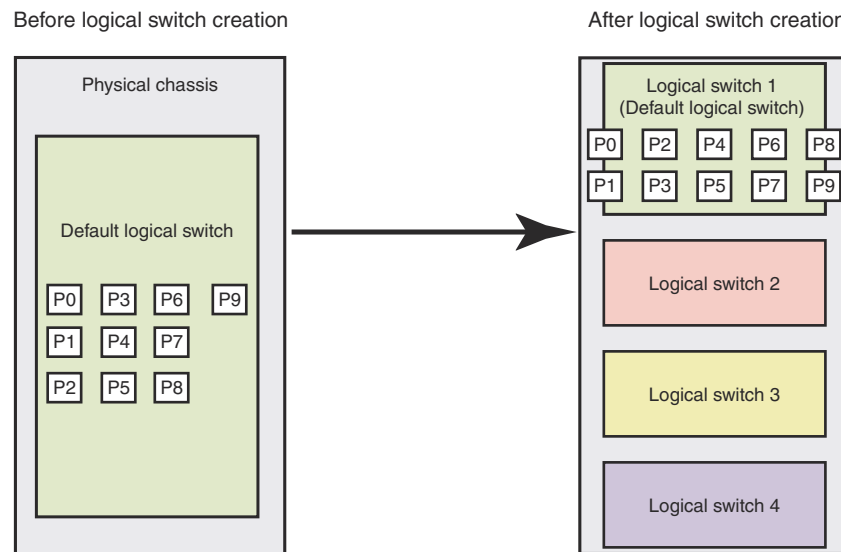

**FIGURE 17** Switch before and after enabling Virtual Fabrics

After you enable Virtual Fabrics, you can create up to seven additional logical switches, depending on the switch model.

Figure 18 shows a Virtual Fabrics-enabled switch before and after it is divided into logical switches. Before you create logical switches, the chassis appears as a single switch (default logical switch). After you create logical switches, the chassis appears as multiple independent logical switches. All of the ports continue to belong to the default logical switch until you explicitly move them to other logical switches.

The default logical switch always exists. You can add and delete other logical switches, but you cannot delete the default logical switch unless you disable Virtual Fabrics.



**FIGURE 18** Switch before and after creating logical switches

## Logical switches and fabric IDs

When you create a logical switch, you must assign it a fabric ID (FID). The fabric ID uniquely identifies each logical switch within a chassis and indicates to which fabric the logical switch belongs. You cannot define multiple logical switches with the same fabric ID within the chassis.

In Figure 19 on page 214, logical switches 2, 3, 4, and 5 are assigned FIDs of 1, 15, 8, and 20, respectively. These logical switches belong to different fabrics, even though they are in the same physical chassis. For example, you could not assign logical switch 5 a fabric ID of 15, because logical switch 3 is already assigned FID 15 in the chassis.

The default logical switch is initially assigned FID 128. You can change this value later.

---

### NOTE

Each logical switch is assigned one and only one FID. The FID identifies the logical fabric to which the logical switch belongs.

---

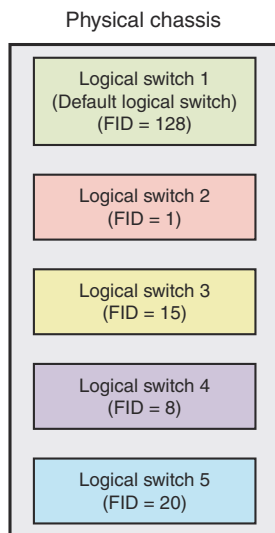

FIGURE 19 Fabric IDs assigned to logical switches

### Port assignment in logical switches

Initially, all ports belong to the default logical switch. When you create additional logical switches, they are empty and you must assign ports to those logical switches. As you assign ports to a logical switch, the ports are moved from the default logical switch to the newly created logical switch. A given port can be in only one logical switch.

In [Figure 20](#), the default logical switch initially has 10 ports, labeled P0 through P9. After logical switches are created, the ports are assigned to specific logical switches. Note that ports 0, 1, 7, and 8 have not been assigned to a logical switch and so remain assigned to the default logical switch.

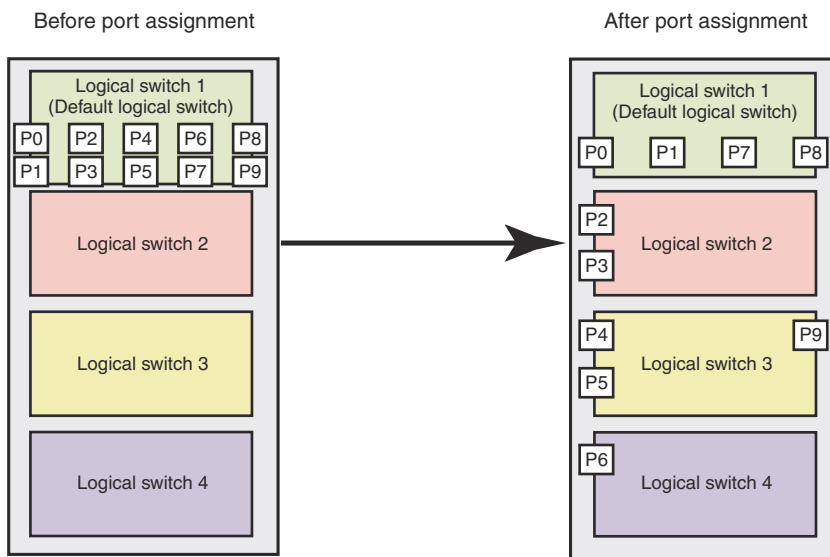

FIGURE 20 Assigning ports to logical switches

A given port is always in one (and only one) logical switch. The following scenarios refer to the chassis after port assignment in [Figure 20](#):

- If you assign P2 to logical switch 2, you cannot assign P2 to any other logical switch.
- If you want to remove a port from a logical switch, you cannot delete it from the logical switch, but must move it to a different logical switch. For example, if you want to remove P4 from logical switch 3, you must assign it to a different logical switch: logical switch 2, logical switch 4, or logical switch 1 (the default logical switch).
- If you assign a port to a logical switch, it is removed automatically from the logical switch it is currently in. If you assign P3 to Logical switch 3, P3 is automatically removed from logical switch 2.
- If you do not assign a port to any logical switch, it remains in the default logical switch, as is the case with ports 0, 1, 7, and 8.

Refer to [“Adding and moving ports on a logical switch”](#) on page 230 for instructions for assigning and moving ports on logical switches.

A logical switch can have as many ports as are available in the chassis. In [Figure 20](#), the chassis has 10 ports. You could assign all 10 ports to a single logical switch, such as logical switch 2; if you did this, however, no ports would be available for logical switches 3 and 4.

You can move only F\_Ports and E\_Ports from one logical switch to another. If you want to configure a different type of port, such as a VE\_Port or EX\_Port, you must configure them after you move them. Some types of ports cannot be moved from the default logical switch. Refer to [“Supported platforms for Virtual Fabrics”](#) on page 222 for detailed information about these ports.

## Logical switches and connected devices

You can connect devices to logical switches, as shown in [Figure 21](#) on page 216. In logical switch 2, P2 is an F\_Port that is connected to H1. In logical switch 3, P4 is an F\_Port that is connected to D1. H1 and D1 cannot communicate with each other because they are in different fabrics, even though they are both connected to the same physical chassis.

You can also connect other switches to logical switches. In [Figure 21](#), P6 is an E\_Port that forms an inter-switch link (ISL) between logical switch 4 and the non-Virtual Fabrics switch. Logical switch 4 is the only logical switch that can communicate with the non-Virtual Fabrics switch and D2, because the other logical switches are in different fabrics.

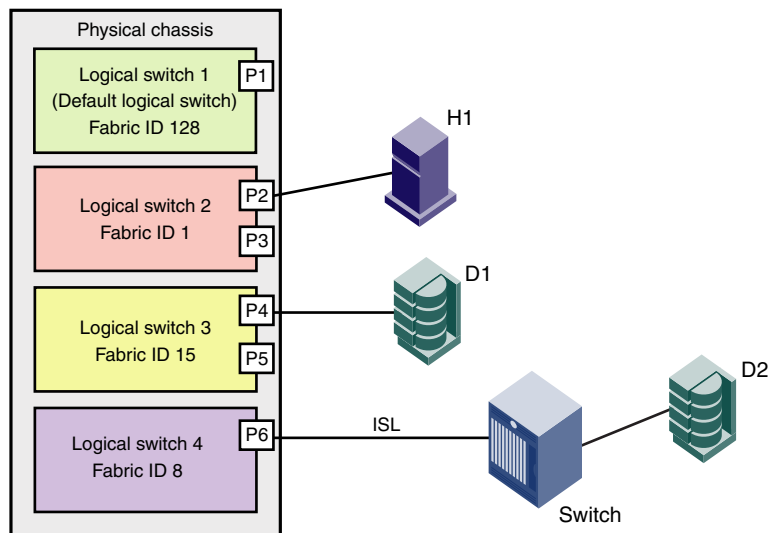

FIGURE 21 Logical switches connected to devices and non-Virtual Fabrics switch

Figure 22 shows a logical representation of the physical chassis and devices in Figure 21. As shown in Figure 22, the devices are isolated into separate fabrics.

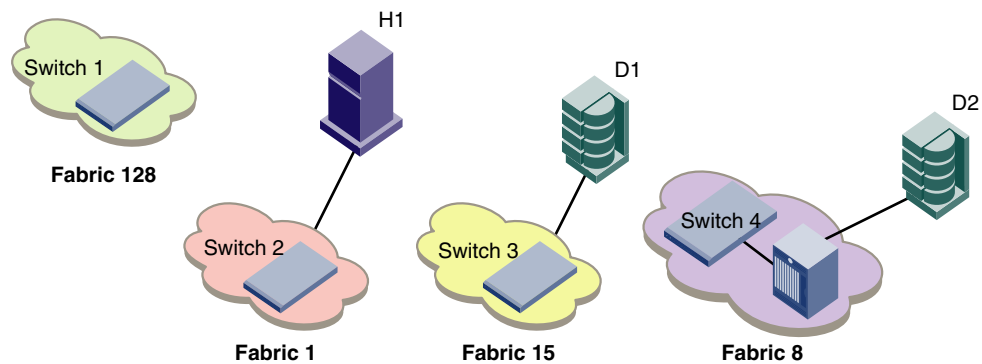

FIGURE 22 Logical switches in a single chassis belong to separate fabrics

For information on allowing device sharing across fabrics in a Virtual Fabrics environment, refer to “FC-FC routing and Virtual Fabrics” on page 501.

## Logical fabric overview

A *logical fabric* is a fabric that contains at least one logical switch. The four fabrics shown in Figure 21 and Figure 22 are logical fabrics because they each have at least one logical switch.

You can connect logical switches to non-Virtual Fabrics switches and to other logical switches.

You connect logical switches to non-Virtual Fabrics switches using an ISL, as shown in Figure 21.

You connect logical switches to other logical switches in two ways:

- Using ISLs
- Using base switches and extended ISLs (XISLs)

## Logical fabric and ISLs

Figure 23 shows two physical chassis divided into logical switches. In Figure 23, ISLs are used to connect the logical switches with FID 1 and the logical switches with FID 15. The logical switches with FID 8 are each connected to a non-Virtual Fabrics switch. The two logical switches and the non-Virtual Fabrics switch are all in the same fabric, with FID 8.

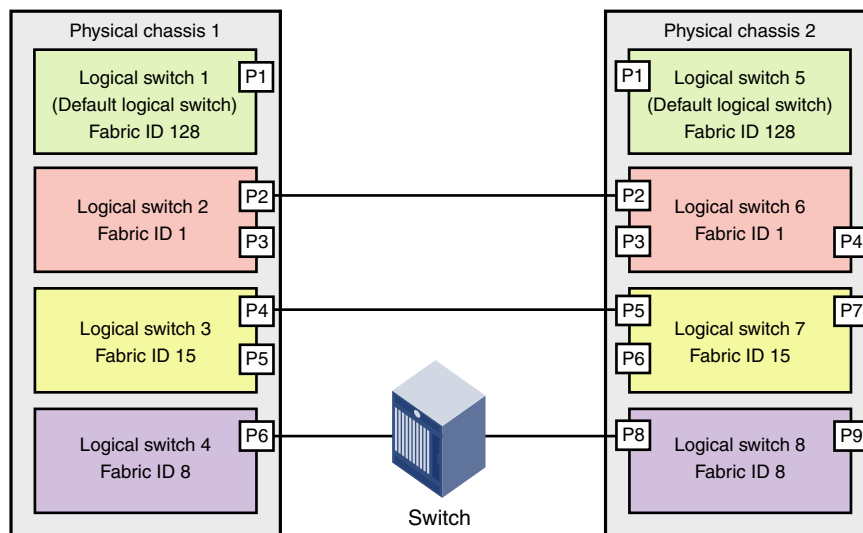

FIGURE 23 Logical switches connected to other logical switches through physical ISLs

Figure 24 shows a logical representation of the configuration in Figure 23.

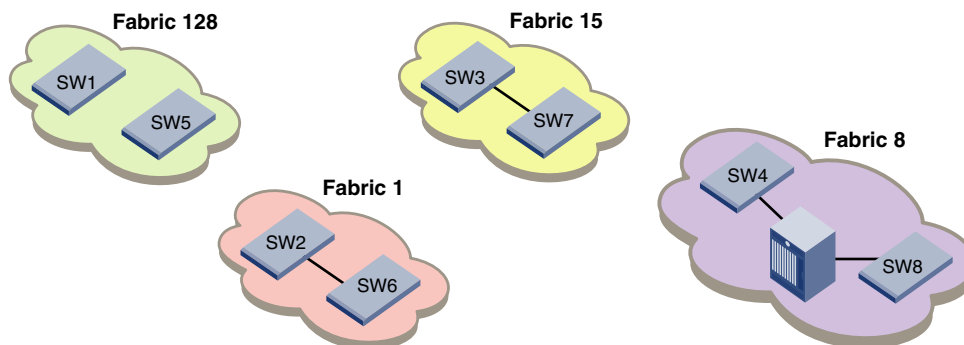

FIGURE 24 Logical switches connected to form logical fabrics

The ISLs between the logical switches are *dedicated ISLs* because they carry traffic only for a single logical fabric. In Figure 23, Fabric 128 has two switches (the default logical switches), but they cannot communicate with each other because they have no ISLs between them and they cannot use the ISLs between the other logical switches.

**NOTE**

Only logical switches with the same FID can form a fabric. If you connect two logical switches with different FIDs, the link between the switches segments.

## Base switch and extended ISLs

Another way to connect logical switches is to use extended ISLs and base switches.

When you divide a chassis into logical switches, you can designate one of the switches to be a base switch. A *base switch* is a special logical switch that is used for interconnecting the physical chassis. A base switch has the following properties:

- ISLs connected through the base switch can be used for communication among the other logical switches.
- Base switches do not support direct device connectivity. A base switch can have only E\_Ports, VE\_Ports, EX\_Ports, or VEX\_Ports, but no F\_Ports.
- The base switch provides a common address space for communication between different logical fabrics.
- A base switch can be configured for the preferred domain ID just like a non-Virtual Fabrics switch.
- You can have only one base switch in a physical chassis.

A base switch can be connected to other base switches through a special ISL, called a *shared ISL* or *extended ISL* (XISL). An extended ISL connects base switches. The XISL is used to share traffic among different logical fabrics.

Fabric formation across an XISL is based on the FIDs of the logical switches.

Figure 25 shows two physical chassis divided into logical switches. Each chassis has one base switch. An ISL connects the two base switches. This ISL is an extended ISL (XISL) because it connects base switches.

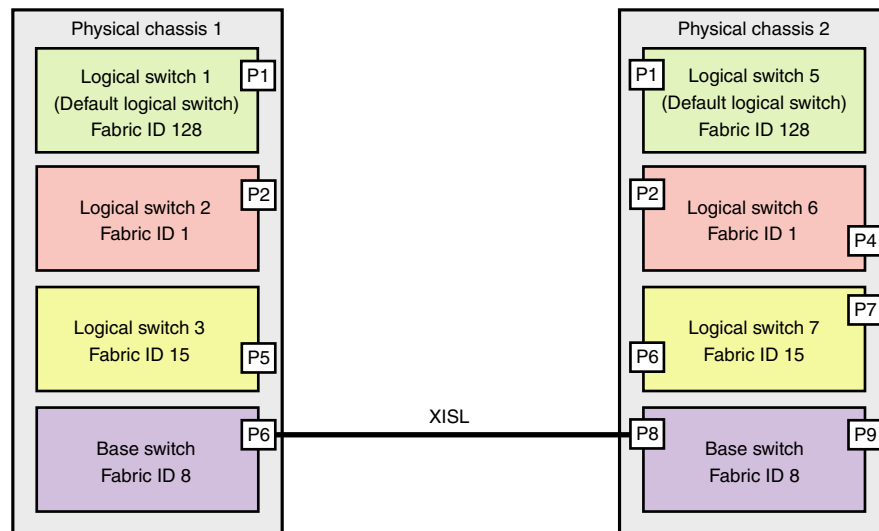
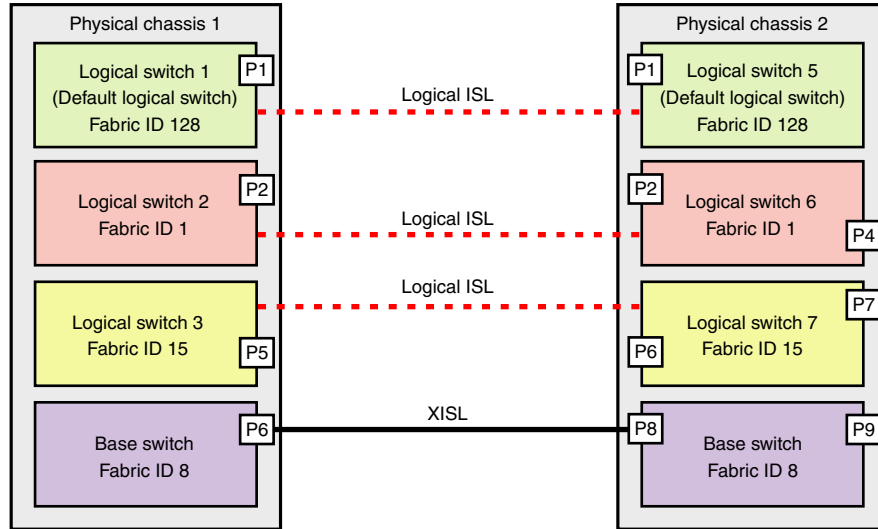

FIGURE 25 Base switches connected by an XISL

Traffic between the logical switches can now flow across this XISL. The traffic can flow only between logical switches with the same fabric ID. For example, traffic can flow between logical switch 2 in chassis 1 and logical switch 6 in chassis 2, because they both have FID 1. Traffic cannot flow between logical switch 2 and logical switch 7, because they have different fabric IDs (and are thus in different fabrics).



Think of the logical switches as being connected with logical ISLs, as shown in [Figure 26](#). In this diagram, the logical ISLs are not connected to ports because they are not physical cables. They are a logical representation of the switch connections that are allowed by the XISL.



**FIGURE 26** Logical ISLs connecting logical switches

To use the XISL, the logical switches must be configured to allow XISL use. By default, they are configured to do so; you can change this setting, however, using the procedure described in [“Configuring a logical switch to use XISLs”](#) on page 234.

**NOTE**

It is a good practice to configure at least two XISLs, for redundancy.

You can also connect logical switches using a combination of ISLs and XISLs, as shown in [Figure 27](#). In this diagram, traffic between the logical switches in FID 1 can travel over either the ISL or the XISL. Traffic between the other logical switches travels only over the XISL.

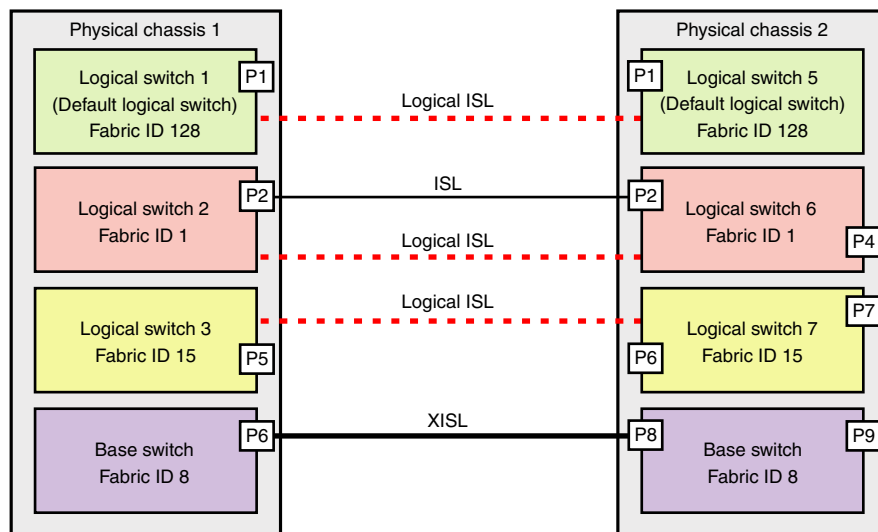

**FIGURE 27** Logical fabric using ISLs and XISLs

By default, the physical ISL path is favored over the logical path (over the XISL) because the physical path has a lower cost. This behavior can be changed by configuring the cost of the dedicated physical ISL to match the cost of the logical ISL.

---

**ATTENTION**

If you disable a base switch, all of the logical ISLs are broken and the logical switches cannot communicate with each other unless they are connected by a physical ISL.

---

### *Base fabric*

Base switch ports on different chassis can be connected together to form a fabric, called a *base fabric*. Similar to other logical switches, the base switches must have the same FID to be connected. If the base switches have different FIDs, the link between the switches is disabled.

The base fabric follows normal routing policies. As long as physical connectivity is available, the base fabric maintains connectivity for the logical fabrics.

### *Logical ports*

As shown in [Figure 27](#), logical ISLs are formed to connect logical switches. A *logical port* represents the ports at each end of a logical ISL. A logical port is a software construct only and does not correspond to any physical port.

Most port commands are not supported on logical ports. For example, you cannot change the state or configuration of a logical port.

The World Wide Name (WWN) for logical ports is in NAA=5 format, using the following syntax:

```
5n:nn:nn:nz:zz:zz:zx:xx
```

The NAA=5 syntax uses the following variables:

- *nnnnnn* is the Brocade Organizationally Unique Identifier (OUI).
- *zzzzzz* is the logical fabric serial number.
- *xxx* is the logical port number, in the range 0 through FFF.

### *Logical fabric formation*

Fabric formation is not based on connectivity, but on the FIDs of the logical switches. The basic order of fabric formation is as follows:

1. Base fabric forms.
2. Logical fabrics form when the base fabric is stable.
3. Traffic is initiated between the logical switches.
4. Devices begin recognizing one another.

## Management model for logical switches

You can use one common IP address for the hardware that is shared by all of the logical switches in the chassis and you can set up individual IPv4 addresses for each Virtual Fabric. For a management host to manage a logical switch using the Internet Protocol over Fibre Channel (IPFC) IP address, it must be physically connected to the Virtual Fabric using a host bus adapter (HBA).

All user operations are classified into one of the following:

- Chassis management operations

These are operations that span logical switch boundaries, such as:

- Logical switch configuration (creating, deleting, or modifying logical switches)
- Account management (determining which accounts can access which logical switches)
- Field-replaceable unit (FRU) management (slot commands, such as **slotShow**)
- Firmware management (firmware upgrade, HA failover)

- Logical switch operations

These are operations that are limited to the logical switch, such as displaying or changing port states. Logical switch operations include all operations that are not covered in the chassis management operations.

When a user logs in, the user is assigned an active context, or active logical switch. This context filters the view that the user gets, and determines which ports the user can see. You can change the active context. For example, if you are working with logical switch 1, you can change the context to logical switch 5. When you change the context to logical switch 5, you only see the ports that are assigned to that logical switch. You do not see any of the other ports in the chassis.

The scope of logical switch operations is defined by the active context. When you are in the context of a logical switch, you can perform port, switch, and fabric-level operations, subject to Role-Based Access Control (RBAC) rules.

If you have permission to execute chassis-level commands, you can do so, regardless of which logical switch context you are in.

## Account management and Virtual Fabrics

When user accounts are created, they are assigned a list of logical fabrics to which they can log in and a home logical fabric (home FID). When you connect to a physical chassis, the home FID defines the logical switch to which you are logged in by default. You can change to a different logical switch context, as described in [“Changing the context to a different logical fabric”](#) on page 235.

When you are logged in to a logical switch, the system prompt changes to display the FID of that switch. The following are example prompts for when you are logged in to the default logical switch (FID = 128) and a user-defined logical switch (FID = 15):

```
switch:FID128:admin>  
switch:FID15:admin>
```

Refer to [Chapter 5, “Managing User Accounts,”](#) for information about creating user accounts and assigning FIDs to user accounts.

## Supported platforms for Virtual Fabrics

The following platforms are Virtual Fabrics-capable:

- Brocade 5100
- Brocade 5300
- Brocade 6510
- Brocade VA-40FC, in Native mode only
- Brocade DCX
- Brocade DCX-4S
- Brocade DCX 8510 family

Some restrictions apply to the ports, depending on the port type and blade type. The following sections explain these restrictions.

### Supported port configurations in the fixed-port switches

There are no restrictions on the ports in the Brocade 5100, 5300, 6510, and VA-40FC; however, the following rules apply:

- Any port can belong to any logical switch (including the base switch and default logical switch), with the exception that F\_Ports cannot belong to the base switch.
- The default logical switch can use XISLs.
- The default logical switch can also be a base switch.

### Supported port configurations in the Brocade Backbones

Some of the ports in the Brocade DCX and DCX 8510 Backbone families are not supported on all types of logical switches. [Table 47](#) lists the blades and ports that are supported on each type of logical switch.

**TABLE 47** Blade and port types supported on logical switches

Blade type	Default logical switch	User-defined logical switch	Base switch
FC8-16	Yes (F, E)	Yes (F, E)	Yes (E, EX)
FC8-32			
FC8-32E			
FC8-48			
FC8-48E			
FC16-32			
FC16-48			
FC8-64	Yes (F, E) <sup>1</sup>	Yes (F, E)	Yes (E, EX) <sup>2</sup>
FC10-6	Yes (F, E)	No	No
FS8-18	Yes (F, E)	No	No
FCOE10-24	Yes (F, E)	No	No
FX8-24: FC ports	Yes (F, E)	Yes (F, E,)	Yes (E, EX)
GE ports	Yes (VE)	Yes (VE)	Yes (VE, VEX)

**TABLE 47** Blade and port types supported on logical switches (Continued)

Blade type	Default logical switch	User-defined logical switch	Base switch
FR4-18i: FC ports	Yes (F, E)	No	No
GE ports	Yes (VE)	Yes (VE)	Yes (VE, VEX)
ICL ports	Yes	Yes	Yes

1. In the Brocade DCX and DCX 8510-8, ports 56–63 of the FC8-64 blade are not supported as E\_Ports on the default logical switch. The Brocade DCX-4S and DCX 8510-4 do not have this limitation.
2. In the Brocade DCX and DCX 8510-8, ports 48–63 of the FC8-64 blade are not supported in the base switch. The Brocade DCX-4S and DCX 8510-4 do not have this limitation.

The following restrictions apply:

- EX\_Ports and VEX\_Ports can be in only the base switch.
- ICL ports cannot be in a logical switch that is using XISLs.
- All of the user ports in an ICL cable must be in the same logical switch. Distributing the user ports within the same cable across multiple logical switches is not supported.
- The default logical switch cannot use XISLs.
- The default logical switch cannot be designated as the base switch.
- VE\_Ports on the FR4-18i blade are supported on the base switch only for carrying Fibre Channel routing (FCR) traffic to VEX\_Ports. These VE\_Ports are not supported for carrying logical fabric traffic over XISLs.
- Starting in Fabric OS v7.0.0, VE\_Ports on the FX8-24 blade are supported on a logical switch that is using an XISL, and on the base switch as an XISL.

**NOTE**

For the FX8-24 blade, if XISL use is enabled it is not recommended that you configure VE\_Ports on both the logical switch and the base switch, because FCIP tunnels support only two hops maximum.

## Virtual Fabrics interaction with other Fabric OS features

Table 48 lists some Fabric OS features and considerations that apply when using Virtual Fabrics.

**TABLE 48** Virtual Fabrics interaction with Fabric OS features

Fabric OS feature	Virtual Fabrics interaction
Access Gateway	Virtual Fabrics is not supported on a switch if AG mode is enabled.
Admin Domains	Virtual Fabrics and Admin Domains are mutually exclusive and are not supported at the same time on a switch. To use Admin Domains, you must first disable Virtual Fabrics; to use Virtual Fabrics, you must first delete all Admin Domains. Refer to <a href="#">“Deleting all user-defined Admin Domains non-disruptively”</a> on page 354 for information on deleting Admin Domains without disrupting device-to-device communication.
Configuration upload and download	Virtual Fabrics uses a configuration file that is different from the configuration file used to download system configuration parameters. Refer to <a href="#">Chapter 8, “Maintaining the Switch Configuration File,”</a> for more information about how Virtual Fabrics affects the configuration file.
Encryption	Encryption functionality using the FS8-18 blade is available only on the default logical switch.

**TABLE 48 Virtual Fabrics interaction with Fabric OS features (Continued)**

Fabric OS feature	Virtual Fabrics interaction
FC-FC Routing Service	<p>All EX_Ports must reside in a base switch. You cannot attach EX_Ports to a logical switch that has XISL use enabled. You must use ISLs to connect the logical switches in an edge fabric.</p> <p><b>NOTE:</b> FC-FC Routing is not supported on a Brocade 6510 with more than 3 logical switches.</p> <p>Refer to <a href="#">Chapter 24, “Using FC-FC Routing to Connect Fabrics,”</a> for more information about Virtual Fabrics and FC-FC routing.</p>
FICON	Up to two logical switches per chassis can run FICON Management Server (CUP), but the FICON logical switch must use ISLs and not XISLs.
Licensing	Licenses are applicable for all logical switches in a chassis.
Performance monitoring	Performance monitors are supported in a limited number of logical switches, depending on the platform type. Refer to <a href="#">Chapter 20, “Monitoring Fabric Performance,”</a> for more information about performance monitoring when Virtual Fabrics is enabled.
QoS	QoS VCs are maintained across the base fabric. Refer to <a href="#">Chapter 21, “Optimizing Fabric Behavior,”</a> for more information about using the Adaptive Networking features with Virtual Fabrics.
Traffic Isolation	Traffic Isolation zones with failover disabled are not supported in logical fabrics. Refer to <a href="#">Chapter 21, “Optimizing Fabric Behavior,”</a> for additional information about using TI Zones with Virtual Fabrics.

## Limitations and restrictions of Virtual Fabrics

The maximum number of logical switches per chassis varies depending on the switch model. [Table 49](#) lists the supported platforms and the maximum number of logical switches (including the default logical switch) supported on each.

**TABLE 49 Maximum number of logical switches per chassis**

Platform	Maximum number of logical switches
Brocade DCX	8
Brocade DCX-4S	8
Brocade DCX 8510 family	8
Brocade 5300	4
Brocade 5100	3
Brocade 6510	4 <sup>1</sup>
Brocade VA-40FC	3

1. The maximum is 3 logical switches if you are using FC-FC routing.

Refer to [“Supported port configurations in the Brocade Backbones”](#) on page 222 for restrictions on the default logical switch.

## Restrictions on XISLs

The **Allow XISL Use** option, available under the **configure** command, allows a logical switch to use XISLs in the base switch as well as any standard ISLs that are connected to that logical switch. To allow or disallow XISL use for a logical switch, see “[Configuring a logical switch to use XISLs](#)” on page 234.

Following are restrictions on XISL use. XISL use is not permitted in any of the following scenarios:

- The logical switch is intended for use with FICON.
- Lossless Dynamic Load Sharing is enabled on the logical switch.
- The logical switch has ICL ports.
- The logical switch is the default logical switch in the Brocade DCX, DCX-4S, or DCX 8510 family.
- The logical switch is a base switch.
- The logical switch is an edge switch for an FC router.

In this case, if the logical switch is enabled, you cannot allow XISL use. If the logical switch is disabled or has not yet joined the edge fabric, you *can* allow XISL use; however, fabric segmentation occurs when the logical switch is enabled or is connected to an edge fabric.

## Restrictions on moving ports

The following are restrictions on moving ports among logical switches:

- FC ports cannot be moved if any one of the following features is enabled:
  - Long distance
  - QoS
  - F\_Port buffers
  - F\_Port trunking
- Before moving VE\_Ports, you must remove the VE\_Port tunnel configuration.
- VE\_Ports on the FX8-24 blade can be moved to any logical switch independent of the location of the physical GE port.

## Enabling Virtual Fabrics mode

A fabric is said to be in *Virtual Fabrics mode* (VF mode) when the Virtual Fabrics feature is enabled. Before you can use the Virtual Fabrics features, such as logical switch and logical fabric, you must enable VF mode.

VF mode is enabled by default.

---

### NOTE

When you enable VF mode, the control processors (CPs) are rebooted and all EX\_Ports are disabled after the reboot.

---

1. Connect to the physical chassis and log in using an account with the chassis-role permission.
2. Enter the following command to check whether VF mode is enabled:

```
fosconfig --show
```

## 10 Disabling Virtual Fabrics mode

3. Delete all Admin Domains, as described in [“Deleting all user-defined Admin Domains non-disruptively”](#) on page 354.
4. Enter the following command to enable VF mode:

```
fosconfig --enable vf
```

5. Enter **y** at the prompt.

### Example

The following example checks whether VF mode is enabled or disabled and then enables it.

```
switch:admin> fosconfig --show
FC Routing service:           disabled
iSCSI service:               Service not supported on this Platform
iSNS client service:         Service not supported on this Platform
Virtual Fabric:              disabled
Ethernet Switch Service:     Service not supported on this Platform

switch:admin> fosconfig --enable vf
WARNING: This is a disruptive operation that requires a reboot to take
effect.
All EX ports will be disabled upon reboot.
Would you like to continue [Y/N] y
VF has been enabled. Your system is being rebooted.
```

## Disabling Virtual Fabrics mode

When you disable VF mode, the following occurs:

- The CPs are rebooted.
- If F\_Port trunking is enabled on ports in the default switch, the F\_Port trunking information is deleted.

If you want to use Admin Domains in a fabric, you must first disable VF mode.

1. Connect to the physical chassis and log in using an account with the chassis-role permission.
2. Enter the following command to check whether VF mode is disabled:

```
fosconfig --show
```

3. Move all ports to the default logical switch.

```
lscfg --config 128 -slot slot -port port
```

4. Delete all of the non-default logical switches.

```
lscfg --delete fabricID
```

5. Enter the following command to disable VF mode:

```
fosconfig --disable vf
```

6. Enter **y** at the prompt.



**Example**

The following example checks whether VF mode is enabled or disabled and then disables it.

```
switchA:FID128:admin> fosconfig --show
FC Routing service:           disabled
iSCSI service:               Service not supported on this Platform
iSNS client service:         Service not supported on this Platform
Virtual Fabric:              enabled
Ethernet Switch Service      Service not supported on this Platform

switch:admin> fosconfig --disable vf
WARNING: This is a disruptive operation that requires a reboot to take
effect.
Would you like to continue [Y/N] y
```

## Configuring logical switches to use basic configuration values

All switches in the fabric are configured to use the same basic configuration values. When you create logical switches, the logical switches might have different configuration values than the default logical switch. Use the following procedure to ensure that newly created logical switches have the same basic configuration values as the default logical switch.

---

**NOTE**

For most users, you do not need to run this procedure. Contact your switch service provider to determine if you need to use this procedure.

---

You need to run this procedure only once on each chassis, after you enable Virtual Fabrics but before you create logical switches. The configuration settings are then preserved across reboots and firmware upgrades and downgrades.

1. Connect to the physical chassis and log in using an account with the chassis-role permission.
2. Enter the following command to ensure that newly created logical switches have the same basic configuration values as the default logical switch:

```
configurechassis
```

3. Enter **n** at the prompts to configure system and cfgload attributes. Enter **y** at the prompt to configure custom attributes.

```
System (yes, y, no, n): [no] n
cfgload attributes (yes, y, no, n): [no] n
Custom attributes (yes, y, no, n): [no] y
```

4. Enter the appropriate value at the Config Index prompt. Contact your switch service provider to determine the appropriate value.

```
Config Index (0 to ignore): (0..1000) [3]:
```

## Creating a logical switch or base switch

When the logical switch is created, it is automatically enabled and is empty—that is, it does not have any ports. After creating the logical switch, you must disable the switch to configure it and set the domain ID. You then assign ports to the logical switch.

Optionally, you can define the logical switch to be a base switch. Each chassis can have only one base switch.

**NOTE**

Domain ID conflicts are detected before fabric ID conflicts. If you have both a domain ID conflict and a fabric ID conflict, only the domain ID conflict is reported.

1. Connect to the physical chassis and log in using an account with the chassis-role permission.

2. Enter the following command to create a logical switch:

```
lscfg --create fabricID [ -base ] [ -force ]
```

In the command syntax, *fabricID* is the fabric ID that is to be associated with the logical switch.

Specify the **-base** option if the logical switch is to be a base switch.

Specify the **-force** option to execute the command without any user prompts or confirmation.

3. Set the context to the new logical switch.

```
setcontext fabricID
```

The *fabricID* parameter is the fabric ID of the logical switch you just created.

4. Disable the logical switch.

```
switchdisable
```

5. Configure the switch attributes, including assigning a unique domain ID.

```
configure
```

6. Enable the logical switch.

```
switchenable
```

7. Assign ports to the logical switch, as described in [“Adding and moving ports on a logical switch”](#) on page 230.

**Example**

The following example creates a logical switch with FID 4, and then assigns domain ID 14 to it.

```
sw0:FID128:admin> lscfg --create 4
About to create switch with fid=4. Please wait...
Logical Switch with FID (4) has been successfully created.

Logical Switch has been created with default configurations.
Please configure the Logical Switch with appropriate switch
and protocol settings before activating the Logical Switch.
sw0:FID128:admin> setcontext 4
switch_4:FID4:admin> switchdisable
switch_4:FID4:admin> configure

Configure...

Fabric parameters (yes, y, no, n): [no] y

Domain: (1..239) [1] 14
WWN Based persistent PID (yes, y, no, n): [no]
...
(output truncated)

WARNING: The domain ID will be changed. The port level zoning may be affected
switch_4:FID4:admin> switchenable
```

## Executing a command in a different logical switch context

This procedure describes how to execute a command for a logical switch while you are in the context of a different logical switch. You can also execute a command for all the logical switches in a chassis.

The command is not executed on those logical switches for which you do not have permission.

1. Connect to the physical chassis and log in using an account with the chassis-role permission.
2. Enter one of the following commands:

- To execute a command in a different logical switch context:

```
fosexec --fid fabricID -cmd "command"
```

- To execute the command on all logical switches:

```
fosexec --fid all -cmd "command"
```

### Example 1: Executing the switchShow command in a different logical switch context

```
sw0:FID128:admin> fosexec --fid 4 -cmd "switchshow"
```

```
-----
"switchshow" on FID 4:
```

```
switchName:      switch_4
switchType:      66.1
switchState:     Online
switchMode:      Native
switchRole:      Principal
switchDomain:    14
switchId:        fffc0e
switchWwn:       10:00:00:05:1e:82:3c:2b
zoning:          OFF
switchBeacon:    OFF
FC Router:       OFF
Fabric Name:     Fab4
Allow XISL Use:  ON
LS Attributes:   [FID: 4, Base Switch: No, Default Switch: No, Address Mode 0]
```

```
Index Port Address Media Speed State      Proto
-----
22 22 0e1600 -- N8 No_Module FC Disabled
23 23 0e1700 -- N8 No_Module FC Disabled
```

### Example 2: Executing the fabricShow command on all logical switches

```
sw0:FID128:admin> fosexec --fid all -cmd "fabricshow"
```

```
-----
"fabricshow" on FID 128:
```

```
Switch ID  Worldwide Name          Enet IP Addr  FC IP Addr  Name
-----
97: fffc61 10:00:00:05:1e:82:3c:2a 10.32.79.105  0.0.0.0     >"sw0"
```

## 10 Deleting a logical switch

"fabricshow" on FID 4:

Switch ID	Worldwide Name	Enet IP Addr	FC IP Addr	Name
14: fffc0e	10:00:00:05:1e:82:3c:2b	10.32.79.105	0.0.0.0	>"switch_4"

(output truncated)

### Deleting a logical switch

You must remove all ports from the logical switch before deleting it.

You cannot delete the default logical switch.

---

#### NOTE

If you are in the context of the logical switch you want to delete, you are automatically logged out when the fabric ID changes. To avoid being logged out, make sure you are in the context of a different logical switch from the one you are deleting.

---

1. Connect to the physical chassis and log in using an account with admin permissions.
2. Remove all ports from the logical switch, as described in [“Adding and moving ports on a logical switch.”](#)
3. Enter the following command to delete the logical switch:

```
lscfg --delete fabricID
```

The *fabricID* parameter is the fabric ID of the logical switch to be deleted.

#### Example of deleting the logical switch with FID 7

```
switch_4:FID4:admin> lscfg --delete 7
All active login sessions for FID 7 have been terminated.
Switch successfully deleted.
```

### Adding and moving ports on a logical switch

This procedure explains how to add and move ports on logical switches.

You add ports to a logical switch by moving the ports from one logical switch to another. See [“Supported platforms for Virtual Fabrics”](#) on page 222 for port restrictions.

If you want to remove a port from a logical switch, you cannot remove it from the logical switch; you must move the port to a different logical switch.

When you move a port from one logical switch to another, the port is automatically disabled. Any performance monitors that were installed on the port are deleted. If monitors are required on the port in its new location, you must manually reinstall them on the port after the move.

---

#### NOTE

If the logical switch to which the port is moved has fabric mode Top Talkers enabled, then if the port is an E\_Port, fabric mode Top Talker monitors are automatically installed on that port.

---

---

**NOTE**

If you are deploying ICLs in the base switch, all ports associated with those ICLs must be assigned to the base switch. If you are deploying ICLs to connect to default switches (that is, XISL use is not allowed), the ICL ports should be assigned (or left) in the default logical switch.

---

1. Connect to the physical chassis and log in using an account with the chassis-role permission.
2. Enter the following command to move ports from one logical switch to another:

```
lscfg --config fabricID -slot slot -port port
```

The ports are assigned to the logical switch specified by *fabricID* and are removed from the logical switch on which they are currently configured.

If the **-port** option is omitted, all ports on the specified slot are assigned to the logical switch.

---

**NOTE**

On the Brocade DCX and DCX 8510-8, the **lscfg** command does not allow you to add ports 48–63 of the FC8-64 blade to the base switch. These ports are not supported on the base switch. The Brocade DCX-4S and DCX 8510-4 do not have this limitation.

---

3. Enter **y** at the prompt.

The ports are automatically disabled, then removed from their current logical switch, and assigned to the logical switch specified by *fabricID*.

**Example of assigning ports 18 through 20 to the logical switch with FID 5**

```
sw0:FID128:admin> lscfg --config 5 -port 18-20
This operation requires that the affected ports be disabled.
Would you like to continue [y/n]?: y
Making this configuration change. Please wait...
Configuration change successful.
Please enable your ports/switch when you are ready to continue.
```

## Displaying logical switch configuration

1. Connect to the physical chassis and log in using an account with the chassis-role permission.
2. Enter the following command to display a list of all logical switches and the ports assigned to them:

```
lscfg --show [ -provision ]
```

If the **-provision** option is specified, all ports on all slots are displayed, regardless of the slot status.

**Example displaying a list of all of the logical switches and the ports assigned to them**

```
sw0:FID128:admin> lscfg --show

Created switches: 128(ds) 4 5

Port      0      1      2      3      4      5      6      7      8      9
-----
FID      128 | 128 | 128 | 128 | 128 | 128 | 128 | 128 | 5 | 5 |
(output truncated)
```

## Changing the fabric ID of a logical switch

The following procedure describes how you can change the fabric ID of an existing logical switch. The fabric ID indicates in which fabric the logical switch participates. By changing the fabric ID, you are moving the logical switch from one fabric to another.

Changing the fabric ID requires permission for chassis management operations. You cannot change the FID of your own logical switch context.

---

### NOTE

If you are in the context of the logical switch with the fabric ID you want to change, you are automatically logged out when the fabric ID changes. To avoid being logged out, make sure you are in the context of a different logical switch from the one with the fabric ID you are changing.

---

1. Connect to the switch and log in using an account with admin permissions.
2. Enter the following command to change the fabric ID of a logical switch:

```
lscfg --change fabricID -newfid newFID
```

3. Enter **y** at the prompt.
4. Enable the logical switch.

```
fosexec --fid newFID -cmd "switchenable"
```

### Example of changing the fabric ID on the logical switch from 5 to 7

```
sw0:FID128:admin> lscfg --change 5 -newfid 7
Changing of a switch fid requires that the switch be disabled.
Would you like to continue [y/n]?: y
Disabling switch...
All active login sessions for FID 5 have been terminated.
Checking and logging message: fid = 5.
Please enable your switch.
sw0:FID128:admin> fosexec --fid 7 -cmd "switchenable"
```

```
-----
"switchenable" on FID 7:
```

## Changing a logical switch to a base switch

1. Connect to the switch and log in using an account with the chassis-role permission.
2. Set the context to the logical switch you want to change, if you are not already in that context.

```
setcontext fabricID
```

where *fabricID* is the fabric ID of the logical switch you want to change to a base switch.

3. Configure the switch to *not* allow XISL use, as described in [“Configuring a logical switch to use XISLs”](#) on page 234.
4. Enter the following command to change the logical switch to a base switch:

```
lscfg --change fabricID -base
```

The *fabricID* parameter is the fabric ID of the logical switch with the attributes you want to change.

## 5. Enable the switch.

```
switchenable
```

**Example of changing the logical switch with FID 7 to a base switch**

```
sw0:FID128:admin> setcontext 7
switch_25:FID7:admin> switchshow
switchName:      switch_25
switchType:      66.1
switchState:     Online
switchMode:      Native
switchRole:      Principal
switchDomain:    30
switchId:        fffc1e
switchWwn:       10:00:00:05:1e:82:3c:2c
zoning:          OFF
switchBeacon:    OFF
FC Router:       OFF
Fabric Name:     MktFab7
Allow XISL Use:  ON
LS Attributes:   [FID: 7, Base Switch: No, Default Switch: No, Address Mode 0]
```

(output truncated)

```
switch_25:FID7:admin> configure
```

Not all options will be available on an enabled switch.  
To disable the switch, use the "switchDisable" command.

Configure...

```
Fabric parameters (yes, y, no, n): [no] y
```

```
WWN Based persistent PID (yes, y, no, n): [no]
```

```
Allow XISL Use (yes, y, no, n): [yes] n
```

```
WARNING!! Disabling this parameter will cause removal of LISLs to  
other logical switches. Do you want to continue? (yes, y, no, n): [no] y
```

```
System services (yes, y, no, n): [no]
```

```
switch_25:FID7:admin> lscfg --change 7 -base
```

Creation of a base switch requires that the proposed new base switch on this system be disabled.

```
Would you like to continue [y/n]?: y
```

```
Disabling the proposed new base switch...
```

```
Disabling switch fid 7
```

```
Please enable your switches when ready.
```

```
switch_25:FID7:admin> switchenable
```

## Setting up IP addresses for a Virtual Fabric

---

### NOTE

IPv6 is not supported when setting the IPFC interface for Virtual Fabrics.

---

1. Connect to the switch and log in using an account with admin permissions.
2. Enter the **ipAddrSet -ls** command. For the **--add** parameter, specify the network information in dotted-decimal notation for the Ethernet IPv4 address with a Classless Inter-Domain Routing (CIDR) prefix.

The following example sets an IP address for a logical switch in a Virtual Fabric with an FID of 123 in non-interactive mode with the CIDR prefix:

```
switch:admin> ipaddrset -ls 123 --add 11.1.2.4/24
```

## Removing an IP address for a Virtual Fabric

1. Connect to the switch and log in using an account with admin permissions.
2. Enter the **ipAddrSet -ls FID -delete** command.

```
switch:admin> ipaddrset -ls 123 -delete
```

## Configuring a logical switch to use XISLs

When you create a logical switch, it is configured to use XISLs by default. Use the following procedure to allow or disallow the logical switch to use XISLs in the base fabric.

XISL use is not supported in some cases. See [“Limitations and restrictions of Virtual Fabrics”](#) on page 224 for restrictions on XISL use.

1. Connect to the physical chassis and log in using an account with the chassis-role permission.
2. Set the context to the logical switch you want to manage, if you are not already in that context.

```
setcontext fabricID
```

The *fabricID* parameter is the fabric ID of the logical switch you want to switch to and manage.

3. Enter the **switchShow** command and check the value of the Allow XISL Use parameter.
4. Enter the following command:

```
configure
```

5. Enter **y** after the Fabric Parameters prompt:

```
Fabric parameters (yes, y, no, n): [no] y
```

6. Enter **y** at the Allow XISL Use prompt to allow XISL use; enter **n** at the prompt to disallow XISL use:

```
Allow XISL Use (yes, y, no, n): y
```

7. Respond to the remaining prompts or press **Ctrl-d** to accept the other settings and exit.



## Changing the context to a different logical fabric

You can change the context to a different logical fabric. Your user account must have permission to access the logical fabric.

1. Connect to the physical chassis and log in using an account with the chassis-role permission.
2. Enter the following command to switch to a different logical switch in the chassis:

```
setcontext fabricID
```

The *fabricID* parameter is the fabric ID of the logical switch you want to switch to and manage.

### Example of changing the context from FID 128 to FID 4

In this example, notice that the prompt changes when you change to a different logical fabric.

```
sw0:FID128:admin> setcontext 4
switch_4:FID4:admin>
```

## Creating a logical fabric using XISLs

This procedure describes how to create a logical fabric using multiple chassis and XISLs and refers to the configuration shown in [Figure 28](#) as an example.

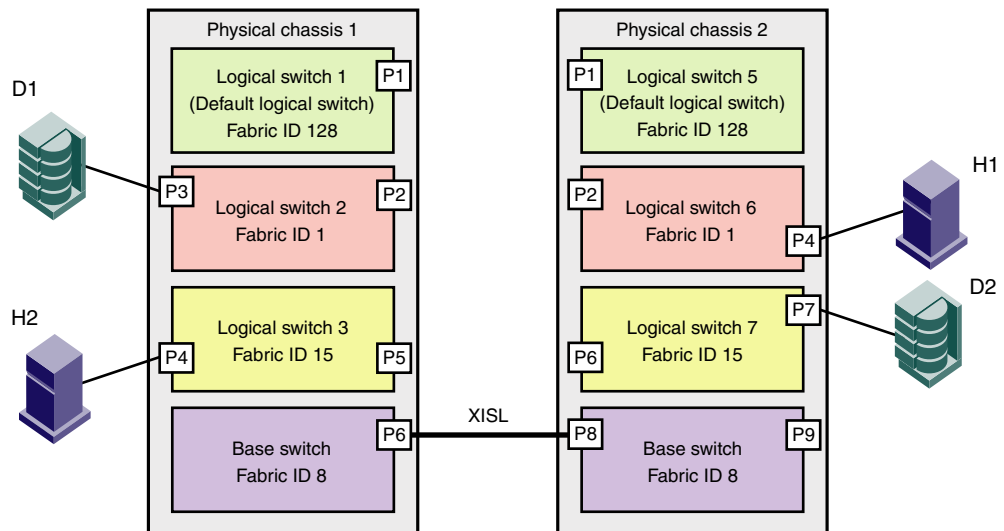

**FIGURE 28** Example of logical fabrics in multiple chassis and XISLs

1. Set up the base switches in each chassis:
  - a. Connect to the physical chassis and log in using an account with the chassis-role permission.
  - b. Enable the Virtual Fabrics feature, if it is not already enabled. See [“Enabling Virtual Fabrics mode”](#) on page 225 for instructions.

Enabling Virtual Fabrics automatically creates the default logical switch, with FID 128. All ports in the chassis are assigned to the default logical switch.

- c. Create a base switch and assign it a fabric ID that will become the FID of the base fabric. See [“Creating a logical switch or base switch”](#) on page 227 for instructions on creating a base switch.  
For the example shown in [Figure 28](#), you would create a base switch with fabric ID 8.
- d. Assign ports to the base switch, as described in [“Adding and moving ports on a logical switch”](#) on page 230.
- e. Repeat [step a](#) through [step d](#) in all chassis that are to participate in the logical fabric.
2. Physically connect ports in the base switches to form XISLs.
3. Enable all of the base switches. This forms the base fabric.
4. Configure the logical switches in each chassis:
  - a. Connect to the physical chassis and log in using an account with the chassis-role permission.
  - b. Create a logical switch and assign it a fabric ID for the logical fabric. This FID must be different from the FID in the base fabric. See [“Creating a logical switch or base switch”](#) on page 227 for instructions.  
For the example shown in [Figure 28](#), you would create a logical switch with FID 1 and a logical switch with FID 15.
  - c. Assign ports to the logical switch, as described in [“Adding and moving ports on a logical switch”](#) on page 230.
  - d. Physically connect devices and ISLs to these ports on the logical switch.
  - e. *(Optional)* Configure the logical switch to use XISLs, if it is not already XISL-capable. See [“Configuring a logical switch to use XISLs”](#) on page 234 for instructions.  
By default, newly created logical switches are configured to allow XISL use.
  - f. Repeat [step a](#) through [step e](#) in all chassis that are to participate in the logical fabric, using the same fabric ID whenever two switches need to be part of a single logical fabric.
5. Enable all logical switches by entering the **switchenable** command on each logical switch that you created in [step 4](#) (the base switches are already enabled).

The logical fabric is formed.

The **fabricShow** command displays all logical switches configured with the same fabric ID as the local switch and all non-Virtual Fabrics switches connected through ISLs to these logical switches.

The **switchShow** command displays logical ports as E\_Ports, with -1 for the slot and the user port number for the slot port.

# Administering Advanced Zoning

---

## In this chapter

• Special zones . . . . .	237
• Zoning overview . . . . .	238
• Broadcast zones . . . . .	244
• Zone aliases . . . . .	246
• Zone creation and maintenance . . . . .	249
• Default zoning mode . . . . .	252
• Zone database size . . . . .	254
• Zone configurations . . . . .	254
• Zone object maintenance . . . . .	260
• Zone configuration management . . . . .	262
• Security and zoning . . . . .	262
• Zone merging . . . . .	263

## Special zones

Fabric OS has the following types of zones:

- Zones
 

Enable you to partition your fabric into logical groups of devices that can access each other. These are “regular” or “standard” zones. Unless otherwise specified, all references to zones in this chapter refer to these regular zones.
- Broadcast zones
 

Control which devices receive broadcast frames. A broadcast zone restricts broadcast packets to only those devices that are members of the broadcast zone. See “[Broadcast zones](#)” on page 244 for more information.
- Frame redirection zones
 

Re-route frames between an initiator and target through a Virtual Initiator and Virtual Target for special processing or functionality, such as for storage virtualization or encryption. See “[Frame Redirection](#)” on page 78 for more information.
- LSAN zones
 

Provide device connectivity between fabrics without merging the fabrics. See “[LSAN zone configuration](#)” on page 485 for more information.

- QoS zones  
Assign high or low priority to designated traffic flows. QoS zones are regular zones with additional QoS attributes specified by adding a QoS prefix to the zone name. See [“QoS: SID/DID traffic prioritization”](#) on page 419 for more information.
- Traffic Isolation zones (TI zones)  
Isolate inter-switch traffic to a specific, dedicated path through the fabric. See [Chapter 12, “Traffic Isolation Zoning,”](#) for more information.

## Zoning overview

Zoning is a fabric-based service that enables you to partition your storage area network (SAN) into logical groups of devices that can access each other.

For example, you can partition your SAN into two zones, *winzone* and *unixzone*, so that your Windows servers and storage do not interact with your UNIX servers and storage. You can use zones to logically consolidate equipment for efficiency or to facilitate time-sensitive functions; for example, you can create a temporary zone to back up nonmember devices.

A device in a zone can communicate only with other devices connected to the fabric within the same zone. A device not included in the zone is not available to members of that zone. When zoning is enabled, devices that are not included in *any* zone configuration are inaccessible to all other devices in the fabric.

Zones can be configured dynamically. They can vary in size, depending on the number of fabric-connected devices, and devices can belong to more than one zone.

Consider [Figure 29](#) on page 239, which shows configured zones, Red, Green, and Blue.

- Server 1 can communicate only with the Storage 1 device.
- Server 2 can communicate only with the RAID and Storage 2 devices.
- Server 3 can communicate with the RAID and Storage 1 devices.
- The Storage 3 is not assigned to a zone; no other zoned fabric device can access it.

---

### NOTE

When using a mixed fabric—that is, a fabric containing two or more switches running different release levels of fabric operating systems—you should use the switch with the highest Fabric OS level to perform zoning tasks.

---

To list the commands associated with zoning, use the **zoneHelp** command. For detailed information on the zoning commands used in the procedures, see the *Fabric OS Command Reference*.

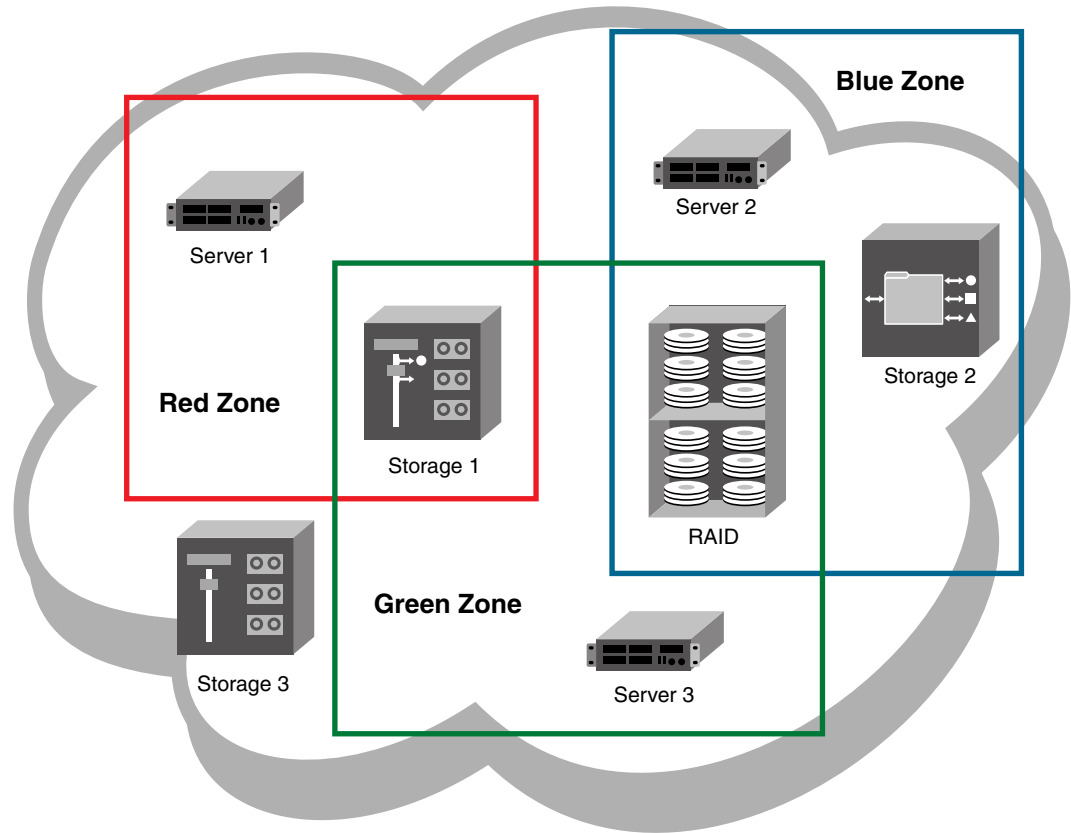

**FIGURE 29** Zoning example

## Approaches to zoning

Table 50 lists the various approaches you can take when implementing zoning in a fabric.

**TABLE 50** Approaches to fabric-based zoning

Zoning approach	Description
<b>Recommended approach</b>	
Single HBA	Zoning by single HBA most closely re-creates the original SCSI bus. Each zone created has only one HBA (initiator) in the zone; each of the target devices is added to the zone. Typically, a zone is created for the HBA and the disk storage ports are added. If the HBA also accesses tape devices, a second zone is created with the HBA and associated tape devices in it. In the case of clustered systems, it could be appropriate to have an HBA from each of the cluster members included in the zone; this is equivalent to having a shared SCSI bus between the cluster members and assumes that the clustering software can manage access to the shared devices. In a large fabric, zoning by single HBA requires the creation of possibly hundreds of zones; however, each zone contains only a few members. Zone changes affect the smallest possible number of devices, minimizing the impact of an incorrect zone change. This zoning philosophy is the preferred method.

**TABLE 50 Approaches to fabric-based zoning (Continued)**

Zoning approach	Description
<b>Alternative approaches</b>	
Application	Zoning by application typically requires zoning multiple, perhaps incompatible, operating systems into the same zones. This method of zoning creates the possibility that a minor server in the application suite could disrupt a major server (such as a Web server disrupting a data warehouse server). Zoning by application can also result in a zone with a large number of members, meaning that more notifications, such as registered state change notifications (RSCNs), or errors, go out to a larger group than necessary.
Operating system	Zoning by operating system has issues similar to zoning by application. In a large site, this type of zone can become very large and complex. When zone changes are made, they typically involve applications rather than a particular server type. If members of different operating system clusters can see storage assigned to another cluster, they might attempt to own the other cluster's storage and compromise the stability of the clusters.
Port allocation	Avoid zoning by port allocation unless the administration team has very rigidly enforced processes for port and device allocation in the fabric. It does, however, provide some positive features. For instance, when a storage port, server HBA, or tape drive is replaced, the change of WWN for the new device is of no consequence. As long as the new device is connected to the original port, it continues to have the same access rights. The ports on the edge switches can be pre-associated to storage ports, and control of the fan-in ratio (the ratio of the input port to output port) can be established. With this pre-assigning technique, the administrative team cannot overload any one storage port by associating too many servers with it.
<b>Not recommended</b>	
No fabric zoning	Using no fabric zoning is the least desirable zoning option because it allows devices to have unrestricted access on the fabric. Additionally, any device attached to the fabric, intentionally or maliciously, likewise has unrestricted access to the fabric. This form of zoning should be utilized only in a small and tightly controlled environment, such as when host-based zoning or LUN masking is deployed.

## Zone objects

A *zone object* is any device in a zone, such as:

- Physical port number or port index on the switch
- Node World Wide Name (N-WWN)
- Port World Wide Name (P-WWN)

Zone objects identified by port number or index number are specified as a pair of decimal numbers in the form *D,I*, where *D* is the domain ID of the switch and *I* is the index number on that switch in relation to the port you want to specify.

For example, in Backbones, “4,30” specifies port 14 in slot number 2 (domain ID 4, port index 30). On fixed-port models, “3,13” specifies port 13 in switch domain ID 3.

Note the following effects on zone membership based on the type of zone object:

- When a zone object is the physical port number, then all devices connected to that port are in the zone.
- World Wide Names are specified as 8-byte (16-digit) hexadecimal numbers, separated by colons (:) for example, 10:00:00:90:69:00:00:8a.
- When a zone object is the node WWN name, only the specified device is in the zone.
- When a zone object is the port WWN name, only the single port is in the zone.

The types of zone objects used to define a zone can be mixed. For example, a zone defined with the zone objects 2,12; 2,14; 10:00:00:80:33:3f:aa:11 contains the devices connected to domain 2, ports 12 and 14, and a device with the WWN 10:00:00:80:33:3f:aa:11 (either node name or port name) that is connected on the fabric.

## ***Zoning schemes***

You can establish a zone by identifying zone objects using one or more of the following *zoning schemes*:

- Domain,index (D,I)  
All members are specified by *domain ID, port number, or domain, index number* pair or aliases.
- World Wide Name (WWN)  
All members are specified only by World Wide Name (WWNs) or aliases of WWNs. They can be node or port versions of the WWN.
- Mixed zoning  
A zone containing members specified by a combination of *domain,port* or *domain,index* or aliases, and WWNs or aliases of WWNs.

In any scheme, you can identify zone objects using aliases.

## **Zone aliases**

A *zone alias* is a name assigned to a device or a group of devices. By creating an alias, you can assign a familiar name to a device or group multiple devices into a single name. This simplifies cumbersome data entry and allows an intuitive naming structure (such as using “NT\_Hosts” to define all NT hosts in the fabric).

Zone aliases also simplify repetitive entry of zone objects such as port numbers or a WWN. For example, you can use the name “Eng” as an alias for “10:00:00:80:33:3f:aa:11”.

Naming zones for the initiator they contain can also be useful. For example, if you use the alias SRV\_MAILSERVER\_SLT5 to designate a mail server in PCI slot 5, then the alias for the associated zone is ZNE\_MAILSERVER\_SLT5. This clearly identifies the server host bus adapter (HBA) associated with the zone.

Zone configuration naming is flexible. One configuration should be named PROD\_*fabricname*, where *fabricname* is the name that the fabric has been assigned. The purpose of the PROD configuration is to easily identify the configuration that can be implemented and provide the most generic services. If other configurations are used for specialized purposes, names such as “BACKUP\_A,” “RECOVERY\_2,” and “TEST\_18jun02” can be used.

## **Zone configurations**

A *zone configuration* is a group of one or more zones. A zone can be included in more than one zone configuration. When a zone configuration is in effect, all zones that are members of that configuration are in effect.

Several zone configurations can reside on a switch at once, and you can quickly alternate between them. For example, you might want to have one configuration enabled during the business hours and another enabled overnight. However, only one zone configuration can be enabled at a time.

The different types of zone configurations are:

- Defined Configuration

The complete set of all zone objects defined in the fabric.

- Effective Configuration

A single zone configuration that is currently in effect. The effective configuration is built when you enable a specified zone configuration.

- Saved Configuration

A copy of the defined configuration plus the name of the effective configuration, which is saved in flash memory. (You can also provide a backup of the zone configuration and restore the zone configuration.) There might be differences between the saved configuration and the defined configuration if you have modified any of the zone definitions and have not saved the configuration.

- Disabled Configuration

The effective configuration is removed from flash memory.

If you disable the effective configuration, the Advanced Zoning feature is disabled on the fabric, and all devices within the fabric can communicate with all other devices (unless you previously set up a default zone, as described in “[Default zoning mode](#)” on page 252). This does not mean that the zone database is deleted, however, only that there is no configuration active in the fabric.

On power-up, the switch automatically reloads the saved configuration. If a configuration was active when it was saved, the same configuration is reinstated on the local switch.

### Zoning enforcement

Zoning enforcement describes a set of predefined rules that the switch uses to determine where to send incoming data. Fabric OS uses hardware-enforced zoning. *Hardware-enforced zoning* means that each frame is checked by hardware (the ASIC) before it is delivered to a zone member and is discarded if there is a zone mismatch. When hardware-enforced zoning is active, the Fabric OS switch monitors the communications and blocks any frames that do not comply with the effective zone configuration. The switch performs this blocking at the transmit side of the port on which the destination device is located.

There are two methods of hardware enforcement:

- Frame-based hardware enforcement: All frames are checked by the hardware.
- Session-based hardware enforcement: The only frames checked by hardware are the ELS frames (such as PLOGI and RNID) used to establish a session.

The method used depends on how the zones are configured.

A zone can contain all WWN members, or all D,I members, or a combination of WWN and D,I members.

Frame-based hardware enforcement is in effect if all members of a zone are identified the same way, either using WWNs or D,I notation, but not both. If the zone includes aliases, then the aliases must also be defined the same way as the zone.

Session-based hardware enforcement is in effect if the zone has a mix of WWN and D,I members.

If a port is in multiple zones, and is defined by WWN in one zone and by D,I in another, then session-based hardware enforcement is in effect.



### *Identifying the enforced zone type*

1. Connect to the switch and log in using an account with admin permissions.
2. Enter the **portZoneShow** command, using the following syntax:

```
portzoneshow
```

## Considerations for zoning architecture

Table 51 lists considerations for zoning architecture.

**TABLE 51** Considerations for zoning architecture

Item	Description
Type of zoning enforcement: frame- or session-based	If security is a priority, frame-based hardware enforcement is recommended. The best way to do this is to use WWN identification exclusively for all zoning configurations.
Use of aliases	The use of aliases is optional with zoning. Using aliases requires structure when defining zones. Aliases aid administrators of zoned fabrics in understanding the structure and context.
Effect of changes in a production fabric	Zone changes in a production fabric can result in a disruption of I/O under conditions when an RSCN is issued because of the zone change and the HBA is unable to process the RSCN fast enough. Although RSCNs are a normal part of a functioning SAN, the pause in I/O might not be acceptable. For these reasons, you should perform zone changes only when the resulting behavior is predictable and acceptable. Ensuring that the HBA drivers are current can shorten the response time in relation to the RSCN.
Testing	Before implementing a new zone, you should run the Zone Analyzer from Web Tools to isolate any possible problems. This is especially useful as fabrics increase in size.
Confirming operation	After changing or enabling a zone configuration, you should confirm that the nodes and storage can identify and access one another. Depending on the platform, you might need to reboot one or more nodes in the fabric with the new changes.

Zoning can be implemented and administered from any switch in the fabric, although it is recommended that you use a switch running the latest Fabric OS version.

The zone configuration is managed on a fabric basis. When a change in the configuration is saved, enabled, or disabled according to the transactional model, it is automatically (by closing the transaction) distributed to all switches in the fabric, preventing a single point of failure for zone information.

### **NOTE**

Zoning commands make changes that affect the entire fabric. When executing fabric-level configuration tasks, allow time for the changes to propagate across the fabric before executing any subsequent commands. For a large fabric, you should wait several minutes between commands.

## Best practices for zoning

The following are recommendations for using zoning:

- Always zone using the highest Fabric OS-level switch.  
Switches with earlier Fabric OS versions do not have the capability to view all the functionality that a newer Fabric OS provides, as functionality is backwards compatible but not forwards compatible.
- Zone using the core switch versus an edge switch.
- Zone using a Backbone rather than a switch.  
A Backbone has more resources to handle zoning changes and implementations.

## Broadcast zones

Fibre Channel allows sending broadcast frames to all Nx\_Ports if the frame is sent to a broadcast well-known address (FFFFFF); however, many target devices and HBAs cannot handle broadcast frames. To control which devices receive broadcast frames, you can create a special zone, called a *broadcast zone*, that restricts broadcast packets to only those devices that are members of the broadcast zone.

If there are no broadcast zones or if a broadcast zone is defined but not enabled, broadcast frames are not forwarded to any F\_Ports. If a broadcast zone is enabled, broadcast frames are delivered only to those logged-in Nx\_Ports that are members of the broadcast zone and are also in the same zone (regular zone) as the sender of the broadcast packet.

Devices that are not members of the broadcast zone can send broadcast packets, even though they cannot receive them.

A broadcast zone can have *domain,port*, WWN, and alias members.

Broadcast zones do not function in the same way as other zones. A broadcast zone does not allow access within its members in any way. If you want to allow or restrict access between any devices, you must create regular zones for that purpose. If two devices are not part of a regular zone, they cannot exchange broadcast or unicast packets.

To restrict broadcast frames reaching broadcast-incapable devices, create a broadcast zone and populate it with the devices that are capable of handling broadcast packets. Devices that cannot handle broadcast frames must be kept out of the broadcast zone so that they do not receive any broadcast frames.

You create a broadcast zone the same way you create any other zone except that a broadcast zone must have the name “broadcast” (case-sensitive). You set up and manage broadcast zones using the standard zoning commands, described in [“Zone creation and maintenance”](#) on page 249.

## Broadcast zones and Admin Domains

Each Admin Domain can have only one broadcast zone. However, all of the broadcast zones from all of the Admin Domains are considered as a single consolidated broadcast zone.

Broadcast packets are forwarded to all the ports that are part of the broadcast zone for any Admin Domain, have membership in that Admin Domain, and are zoned together (in a regular zone) with the sender of the broadcast frame.

Figure 30 illustrates how broadcast zones work with Admin Domains. Figure 30 shows a fabric with five devices and two Admin Domains, AD1 and AD2. Each Admin Domain has two devices and a broadcast zone.

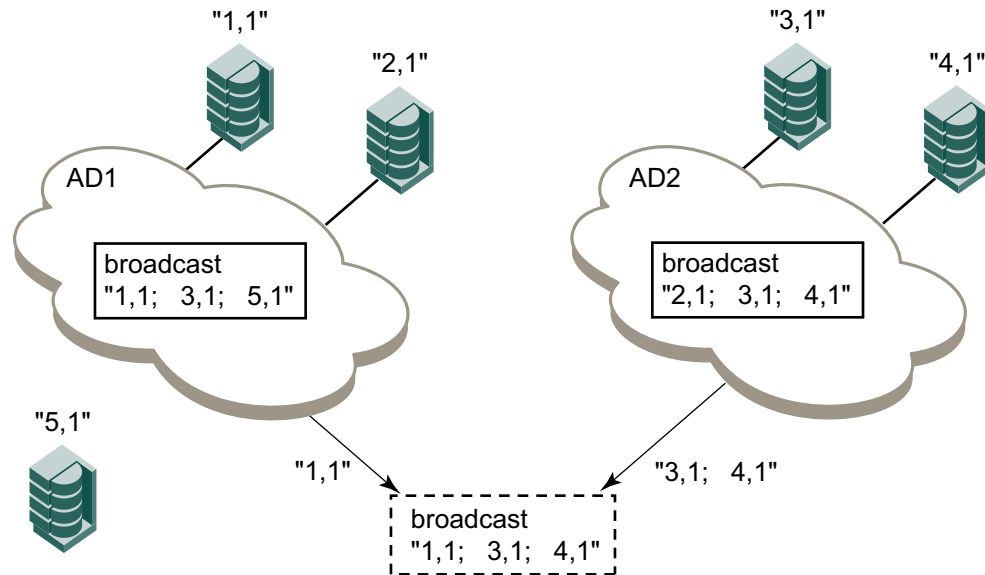

FIGURE 30 Broadcast zones and Admin Domains

The dotted box represents the consolidated broadcast zone, which contains all of the devices that can receive broadcast packets. The actual delivery of broadcast packets is also controlled by the Admin Domain and zone enforcement logic. The consolidated broadcast zone is not an actual zone, but is just an abstraction used for explaining the behavior.

- The broadcast zone for AD1 includes member devices “1,1”, “3,1” and “5,1”; however, “3,1” and “5,1” are not members of AD1. Consequently, from the AD1 broadcast zone, only “1,1” is added to the consolidated broadcast zone.
- The broadcast zone for AD2 includes member devices “2,1”, “3,1”, and “4,1”. Even though “2,1” is a member of AD1, it is not a member of AD2 and so is not added to the consolidated broadcast zone.
- Device “3,1” is added to the consolidated broadcast zone because of its membership in the AD2 broadcast zone.

When a switch receives a broadcast packet it forwards the packet only to those devices which are zoned with the sender and are also part of the consolidated broadcast zone.

You can check whether a broadcast zone has any invalid members that cannot be enforced in the current AD context. Refer to [“Validating a zone”](#) on page 251 for complete instructions.

## Broadcast zones and FC-FC routing

If you create broadcast zones in a metaSAN consisting of multiple fabrics connected through an FC router, the broadcast zone must include the IP device that exists in the edge or backbone fabric as well as the proxy device in the remote fabric. See [Chapter 24, “Using FC-FC Routing to Connect Fabrics,”](#) for information about proxy devices and the FC router.

## High availability considerations with broadcast zones

If a switch has broadcast zone-capable firmware on the active CP (Fabric OS v5.3.x or later) and broadcast zone-incapable firmware on the standby CP (Fabric OS version earlier than v5.3.0), then you cannot create a broadcast zone because the zoning behavior would not be the same across an HA failover. If the switch failed over, then the broadcast zone would lose its special significance and would be treated as a regular zone.

## Loop devices and broadcast zones

Delivery of broadcast packets to individual devices in a loop is not controlled by the switch. Consequently, adding loop devices to a broadcast zone does not have any effect. If a loop device is part of a broadcast zone, then all devices in that loop receive broadcast packets.

**Best practice:** All devices in a single loop should have uniform broadcast capability. If all the devices in the loop can handle broadcast frames, then add the FL\_Port to the broadcast zone.

## Broadcast zones and default zoning mode

The default zoning mode defines the device accessibility behavior if zoning is not implemented or if there is no effective zone configuration. The default zoning mode has two options:

- All Access—All devices within the fabric can communicate with all other devices.
- No Access—Devices in the fabric cannot access any other device in the fabric.

If a broadcast zone is active, even if it is the only zone in the effective configuration, the default zone setting is not in effect.

If the effective configuration has only a broadcast zone, then the configuration appears as a No Access configuration. To change this configuration to All Access, you must put all the available devices in a regular zone.

See [“Default zoning mode”](#) on page 252 for additional information about default zoning.

## Zone aliases

A zone alias is a logical group of ports or WWNs. You can simplify the process of creating zones by first specifying aliases, which eliminates the need for long lists of individual zone member names.

If you are creating a new alias using **aliCreate w**, “1,1”, and a user in another Telnet session executes **cfgEnable** (or **cfgDisable**, or **cfgSave**), the other user’s transaction will abort your transaction and you will receive an error message. Creating a new alias while there is a zone merge taking place might also abort your transaction. For more details about zone merging and zone merge conflicts, see [“Zone merging”](#) on page 263.

**Virtual Fabrics considerations:** Alias definitions should not include logical port numbers. Zoning is not enforced on logical ports.

## Creating an alias

1. Connect to the switch and log in using an account with admin permissions.
2. Enter the **aliCreate** command, using the following syntax:

```
alicreate "aliasname", "member[; member...]"
```

3. Enter the **cfgSave** command to save the change to the defined configuration.

The **cfgSave** command ends and commits the current zoning transaction buffer to nonvolatile memory. If a transaction is open on a different switch in the fabric when this command is run, the transaction on the other switch is automatically aborted. A message displays on the other switches to indicate that the transaction was aborted.

### Example

```
switch:admin> alicreate "array1", "2,32; 2,33; 2,34; 4,4"
switch:admin> alicreate "array2", "21:00:00:20:37:0c:66:23; 4,3"
switch:admin> alicreate "loop1", "4,6"
switch:admin> cfgsave
You are about to save the Defined zoning configuration. This
action will only save the changes on the Defined configuration.
Any changes made on the Effective configuration will not
take effect until it is re-enabled. Until the Effective
configuration is re-enabled, merging new switches into the
fabric is not recommended and may cause unpredictable
results with the potential of mismatched Effective Zoning
configurations.
Do you want to save Defined zoning configuration only? (yes, y, no, n): [no] y
```

## Adding members to an alias

1. Connect to the switch and log in using an account with admin permissions.
2. Enter the **aliAdd** command, using the following syntax:

```
aliadd "aliasname", "member[; member...]"
```

3. Enter the **cfgSave** command to save the change to the defined configuration.

The **cfgSave** command ends and commits the current zoning transaction buffer to nonvolatile memory. If a transaction is open on a different switch in the fabric when this command is run, the transaction on the other switch is automatically aborted. A message displays on the other switches to indicate that the transaction was aborted.

### Example

```
switch:admin> aliadd "array1", "1,2"
switch:admin> aliadd "array2", "21:00:00:20:37:0c:72:51"
switch:admin> aliadd "loop1", "5,6"
switch:admin> cfgsave
You are about to save the Defined zoning configuration. This
action will only save the changes on the Defined configuration.
Any changes made on the Effective configuration will not
take effect until it is re-enabled. Until the Effective
configuration is re-enabled, merging new switches into the
fabric is not recommended and may cause unpredictable
results with the potential of mismatched Effective Zoning
configurations.
Do you want to save Defined zoning configuration only? (yes, y, no, n): [no] y
```

## Removing members from an alias

1. Connect to the switch and log in using an account with admin permissions.
2. Enter the **aliRemove** command, using the following syntax:

```
aliremove "aliasname", "member[; member...]"
```

3. Enter the **cfgSave** command to save the change to the defined configuration.

The **cfgSave** command ends and commits the current zoning transaction buffer to nonvolatile memory. If a transaction is open on a different switch in the fabric when this command is run, the transaction on the other switch is automatically aborted. A message displays on the other switches to indicate that the transaction was aborted.

### Example

```
switch:admin> aliremove "array1", "1,2"
switch:admin> aliremove "array2", "21:00:00:20:37:0c:72:51"
switch:admin> aliremove "loop1", "4,6"
switch:admin> cfgsave
You are about to save the Defined zoning configuration. This
action will only save the changes on the Defined configuration.
Any changes made on the Effective configuration will not
take effect until it is re-enabled. Until the Effective
configuration is re-enabled, merging new switches into the
fabric is not recommended and may cause unpredictable
results with the potential of mismatched Effective Zoning
configurations.
Do you want to save Defined zoning configuration only? (yes, y, no, n): [no] y
```

## Deleting an alias

1. Connect to the switch and log in using an account with admin permissions.
2. Enter the **aliDelete** command, using the following syntax.

```
alidelete "aliasname"
```

3. Enter the **cfgSave** command to save the change to the defined configuration.

The **cfgSave** command ends and commits the current zoning transaction buffer to nonvolatile memory. If a transaction is open on a different switch in the fabric when this command is run, the transaction on the other switch is automatically aborted. A message displays on the other switches to indicate that the transaction was aborted.

### Example

```
switch:admin> alidelete "array1"
switch:admin> cfgsave
You are about to save the Defined zoning configuration. This
action will only save the changes on the Defined configuration.
Any changes made on the Effective configuration will not
take effect until it is re-enabled. Until the Effective
configuration is re-enabled, merging new switches into the
fabric is not recommended and may cause unpredictable
results with the potential of mismatched Effective Zoning
configurations.
Do you want to save Defined zoning configuration only? (yes, y, no, n): [no] y
```

## Viewing an alias in the defined configuration

1. Connect to the switch and log in using an account with admin permissions.
2. Enter the **aliShow** command, using the following syntax

```
alishow "pattern" [, mode]
```

If no parameters are specified, the entire zone database (both the defined and effective configuration) is displayed.

### Example

The following example shows all zone aliases beginning with “arr”.

```
switch:admin> alishow "arr*"
alias: array1 21:00:00:20:37:0c:76:8c
alias: array2 21:00:00:20:37:0c:66:23
```

## Zone creation and maintenance

To create a broadcast zone, use the reserved name “broadcast”. Do not give a regular zone the name of “broadcast”. See [“Broadcast zones”](#) on page 244 for additional information about this special type of zone.

**Virtual Fabrics considerations:** Zone definitions should not include logical port numbers. Zoning is not enforced on logical ports.

### Creating a zone

1. Connect to the switch and log in using an account with admin permissions.
2. Enter the **zoneCreate** command, using the following syntax:

```
zonecreate "zonename", "member[; member...]"
```

To create a broadcast zone, use the reserved name “broadcast”.

3. Enter the **cfgSave** command to save the change to the defined configuration.

The **cfgSave** command ends and commits the current zoning transaction buffer to nonvolatile memory. If a transaction is open on a different switch in the fabric when this command is run, the transaction on the other switch is automatically aborted. A message displays on the other switches to indicate that the transaction was aborted.

### Example

```
switch:admin> zonecreate "greenzone", "2,32; 2,33; 2,34; 4,4"
switch:admin> zonecreate "bluezone", "21:00:00:20:37:0c:66:23; 4,3"
switch:admin> zonecreate "broadcast", "1,2; 2,33; 2,34"
switch:admin> cfgsave
```

You are about to save the Defined zoning configuration. This action will only save the changes on the Defined configuration. Any changes made on the Effective configuration will not take effect until it is re-enabled. Until the Effective configuration is re-enabled, merging new switches into the fabric is not recommended and may cause unpredictable results with the potential of mismatched Effective Zoning configurations. Do you want to save Defined zoning configuration only? (yes, y, no, n): [no] **y**

## Adding devices (members) to a zone

1. Connect to the switch and log in using an account with admin permissions.
2. Enter the **zoneAdd** command, using the following syntax:

```
zoneadd "zonename", "member[; member...]"
```

3. Enter the **cfgSave** command to save the change to the defined configuration.

The **cfgSave** command ends and commits the current zoning transaction buffer to nonvolatile memory. If a transaction is open on a different switch in the fabric when this command is run, the transaction on the other switch is automatically aborted. A message displays on the other switches to indicate that the transaction was aborted.

### Example

```
switch:admin> zoneadd "greenzone", "1,2"
switch:admin> zoneadd "bluezone", "21:00:00:20:37:0c:72:51"
switch:admin> zoneadd "broadcast", "1,3"
switch:admin> cfgsave
You are about to save the Defined zoning configuration. This
action will only save the changes on the Defined configuration.
Any changes made on the Effective configuration will not
take effect until it is re-enabled. Until the Effective
configuration is re-enabled, merging new switches into the
fabric is not recommended and may cause unpredictable
results with the potential of mismatched Effective Zoning
configurations.
Do you want to save Defined zoning configuration only? (yes, y, no, n): [no] y
```

## Removing devices (members) from a zone

1. Connect to the switch and log in using an account with admin permissions.
2. Enter the **zoneRemove** command, using the following syntax:

```
zoneremove "zonename", "member[; member...]"
```

3. Enter the **cfgSave** command to save the change to the defined configuration.

The **cfgSave** command ends and commits the current zoning transaction buffer to nonvolatile memory. If a transaction is open on a different switch in the fabric when this command is run, the transaction on the other switch is automatically aborted. A message displays on the other switches to indicate that the transaction was aborted.

### Example

```
switch:admin> zoneremove "greenzone", "1,2"
switch:admin> zoneremove "bluezone", "21:00:00:20:37:0c:72:51"
switch:admin> zoneremove "broadcast", "2,34"
switch:admin> cfgsave
You are about to save the Defined zoning configuration. This
action will only save the changes on the Defined configuration.
Any changes made on the Effective configuration will not
take effect until it is re-enabled. Until the Effective
configuration is re-enabled, merging new switches into the
fabric is not recommended and may cause unpredictable
results with the potential of mismatched Effective Zoning
configurations.
Do you want to save Defined zoning configuration only? (yes, y, no, n): [no] y
```



## Deleting a zone

1. Connect to the switch and log in using an account with admin permissions.
2. Enter the **zoneDelete** command, using the following syntax:

```
zonedelete "zonename"
```

3. Enter the **cfgSave** command to save the change to the defined configuration.

The **cfgSave** command ends and commits the current zoning transaction buffer to nonvolatile memory. If a transaction is open on a different switch in the fabric when this command is run, the transaction on the other switch is automatically aborted. A message displays on the other switches to indicate that the transaction was aborted.

### Example

```
switch:admin> zonedelete "bluezone"
switch:admin> cfgsave
You are about to save the Defined zoning configuration. This
action will only save the changes on the Defined configuration.
Any changes made on the Effective configuration will not
take effect until it is re-enabled. Until the Effective
configuration is re-enabled, merging new switches into the
fabric is not recommended and may cause unpredictable
results with the potential of mismatched Effective Zoning
configurations.
Do you want to save Defined zoning configuration only? (yes, y, no, n): [no] y
```

## Viewing a zone in the defined configuration

1. Connect to the switch and log in using an account with admin permissions.
2. Enter the **zoneShow** command, using the following syntax:

```
zonestow[--sort] ["pattern"] [, mode]
```

If no parameters are specified, the entire zone database (both the defined and effective configuration) is displayed.

### Example

The following example shows all zones beginning with A, B, or C, in ascending order:

```
switch:admin> zonestow --sort "[A-C]*"
zone: Blue_zone 1,1; array1; 1,2; array2
zone: Bobs_zone 4,5; 4,6; 4,7; 4,8; 4,9
```

## Validating a zone

1. Connect to the switch and log in using an account with admin permissions.
2. Enter the **cfgShow** command to view the zone configuration objects you want to validate.

```
switch:admin> cfgShow
Defined configuration:
cfg: USA_cfg Purple_zone; White_zone; Blue_zone
zone: Blue_zone
      1,1; array1; 1,2; array2
zone: Purple_zone
```

## 11 Default zoning mode

```
1,0; loop1
zone: White_zone
1,3; 1,4
alias: array1 21:00:00:20:37:0c:76:8c; 21:00:00:20:37:0c:71:02
alias: array2 21:00:00:20:37:0c:76:22; 21:00:00:20:37:0c:76:28
alias: loop1 21:00:00:20:37:0c:76:85; 21:00:00:20:37:0c:71:df
```

3. Enter the **zone --validate** command to list all zone members that are not part of the current zone enforcement table. Note that zone configuration names are case-sensitive; blank spaces are ignored.

```
switch:admin> zone --validate "White_zone"
```

4. Enter the following command to validate all zones in the zone database in the defined configuration.

```
switch:admin> sw5:root> zone --validate -m 1
Defined configuration:
cfg:  cfg1    zone1
cfg:  cfg2    zone1; zone2
zone: zone1  1,1; ali1
zone: zone2  1,1; ali2
alias: ali1  10:00:00:05:1e:35:81:7f*; 10:00:00:05:1e:35:81:7d*
alias: ali2  10:00:00:05:1e:35:81:09*; 10:00:00:05:1e:35:81:88*

-----
~ - Invalid configuration
* - Member does not exist
```

The mode flag **-m** can be used to specify the zone database location. Supported mode flag values are:

- 0 - zone database from the current transaction buffer
- 1 - zone database stored from the persistent storage
- 2 - currently effective zone database.

If no mode options are given, the validated output of all three buffers is shown.

If the **-f** option is specified, all the zone members that are not enforceable would be expunged in the transaction buffer. This pruning operation always happens on the transaction and defined buffers. You cannot specify a mode option or specify a zone object as an argument with the **-f** option. This mode flag should be used after the zone has been validated.

## Default zoning mode

The default zoning mode controls device access if zoning is not implemented or if there is no effective zone configuration. The default zoning mode has two options:

- All Access—All devices within the fabric can communicate with all other devices.
- No Access—Devices in the fabric cannot access any other device in the fabric.

The default zone mode applies to the entire fabric, regardless of switch model.

The default setting is All Access.

Typically, when you disable the zoning configuration in a large fabric with thousands of devices, the name server indicates to all hosts that they can communicate with each other. In fact, each host can receive an enormous list of PIDs, and ultimately cause other hosts to run out of memory or crash. To ensure that all devices in a fabric do not see each other during a configuration disable operation, set the default zoning mode to No Access.

**NOTE**

For switches in large fabrics, the default zone mode should be set to No Access. You cannot disable the effective configuration if the default zone mode is All Access and you have more than 120 devices in the fabric.

**Admin Domain considerations:** If you want to use Admin Domains, you must set the default zoning mode to No Access prior to setting up the Admin Domains. You cannot change the default zoning mode to All Access if user-specified Admin Domains are present in the fabric.

## Setting the default zoning mode

**NOTE**

You should not change the default zone mode from No Access to All Access if there is no effective zone configuration and more than 120 devices are connected to the fabric.

1. Connect to the switch and log in using an account with admin permissions.
2. Enter the **cfgActvShow** command to view the current zone configuration.
3. Enter the **defZone** command with one of the following options:

```
defzone --noaccess
```

```
defzone --allaccess
```

This command initiates a transaction (if one is not already in progress).

4. Enter either the **cfgSave**, **cfgEnable**, or **cfgDisable** command to commit the change and distribute it to the fabric. The change will not be committed and distributed across the fabric if you do not enter one of these commands.

**Example**

```
switch:admin> defzone --noaccess
You are about to set the Default Zone access mode to No Access
Do you want to set the Default Zone access mode to No Access ? (yes, y, no, n):
[no] y

switch:admin> cfgsave
You are about to save the Defined zoning configuration. This
action will only save the changes on Defined configuration.
Any changes made on the Effective configuration will not
take effect until it is re-enabled. Until the Effective
configuration is re-enabled, merging new switches into the
fabric is not recommended and may cause unpredictable
results with the potential of mismatched Effective Zoning
configurations.
Do you want to save Defined zoning configuration only? (yes, y, no, n): [no] y
Updating flash ...
```

## Viewing the current default zone access mode

1. Connect to the switch and log in using an account with admin permissions.
2. Enter the **defZone --show** command.

---

### NOTE

If you perform a firmware download of an older release, then the current default zone access state will appear as it did prior to the download. For example, if the default zoning mode was No Access before the download, it will remain as No Access afterward.

---

## Zone database size

The maximum size of a zone database is the upper limit for the defined configuration, and it is determined by the amount of flash memory available for storing the defined configuration.

Use the **cfgSize** command to display the zone database size.

The supported maximum zone database size is 1 MB.

**Virtual Fabric considerations:** If Virtual Fabrics is enabled, the sum of the zone database sizes on all of the logical fabrics must not exceed the maximum size allowed for the chassis (1 MB). The maximum size limit is enforced per-partition, but is not enforced chassis-wide. If the chassis size limit is exceeded, you are not informed of this and unpredictable behavior might occur. It is your responsibility to keep track of the chassis-wide zone database size.

---

### ATTENTION

In a fabric with some switches running Fabric OS 7.0.0 or later and some switches running Fabric OS versions earlier than 7.0.0, if you execute the **cfgSave** or **cfgEnable** command from a pre-7.0.0 switch, a zone database size of 128 KB is enforced.

To avoid this problem, use the switch with the highest Fabric OS version to perform zoning tasks, as described in [“Best practices for zoning”](#) on page 244. Alternatively make sure that your pre-7.0.0 switches are upgraded with the latest patch release.

---

## Zone configurations

You can store a number of zones in a zone configuration database. The maximum number of items that can be stored in the zone configuration database depends on the following criteria:

- Number of switches in the fabric.
- Number of bytes for each item name. The number of bytes required for an item name depends on the specifics of the fabric, but cannot exceed 64 bytes for each item.

When enabling a new zone configuration, ensure that the size of the defined configuration does not exceed the maximum configuration size supported by all switches in the fabric. This is particularly important if you downgrade to a Fabric OS version that supports a smaller zone database than the current Fabric OS. In this scenario, the zone database in the current Fabric OS would have to be changed to the smaller zone database before the downgrade.

You can use the **cfgSize** command to check both the maximum available size and the currently saved size on all switches. If you think you are approaching the maximum, you can save a partially completed zone configuration and use the **cfgSize** command to determine the remaining space. The **cfgSize** command reports the maximum available size on the current switch only. It cannot determine the maximum available size on other switches in the fabric.

---

#### NOTE

The minimum zone database size is 4 bytes, even if the zone database is empty.

---

For important considerations for managing zoning in a fabric, and more details about the maximum zone database size for each version of the Fabric OS, see [“Zone database size”](#) on page 254.

If you create or make changes to a zone configuration, you must enable the configuration for the changes to take effect.

## Creating a zone configuration

1. Connect to the switch and log in using an account with admin permissions.
2. Enter the **cfgCreate** command, using the following syntax:

```
cfgcreate "cfgname", "member[; member...]"
```

3. Enter the **cfgSave** command to save the change to the defined configuration.

The **cfgSave** command ends and commits the current zoning transaction buffer to nonvolatile memory. If a transaction is open on a different switch in the fabric when this command is run, the transaction on the other switch is automatically aborted. A message displays on the other switches to indicate that the transaction was aborted.

#### Example

```
switch:admin> cfgcreate "NEW_cfg", "purplezone; bluezone; greenzone"
switch:admin> cfgsave
You are about to save the Defined zoning configuration. This
action will only save the changes on the Defined configuration.
Any changes made on the Effective configuration will not
take effect until it is re-enabled. Until the Effective
configuration is re-enabled, merging new switches into the
fabric is not recommended and may cause unpredictable
results with the potential of mismatched Effective Zoning configurations.
Do you want to save Defined zoning configuration only? (yes, y, no, n): [no] y
```

## Adding zones (members) to a zone configuration

1. Connect to the switch and log in using an account with admin permissions.
2. Enter the **cfgAdd** command, using the following syntax:

```
cfgadd "cfgname", "member[; member...]"
```

3. Enter the **cfgSave** command to save the change to the defined configuration.

The **cfgSave** command ends and commits the current zoning transaction buffer to nonvolatile memory. If a transaction is open on a different switch in the fabric when this command is run, the transaction on the other switch is automatically aborted. A message displays on the other switches to indicate that the transaction was aborted.

## 11 Zone configurations

### Example

```
switch:admin> cfgadd "newcfg", "bluezone"
switch:admin> cfgsave
You are about to save the Defined zoning configuration. This
action will only save the changes on the Defined configuration.
Any changes made on the Effective configuration will not
take effect until it is re-enabled. Until the Effective
configuration is re-enabled, merging new switches into the
fabric is not recommended and may cause unpredictable
results with the potential of mismatched Effective Zoning
configurations.
Do you want to save Defined zoning configuration only? (yes, y, no, n): [no] y
```

### Removing zones (members) from a zone configuration

1. Connect to the switch and log in using an account with admin permissions.
2. Enter the **cfgRemove** command, using the following syntax:

```
cfgremove "cfgname", "member[; member...]"
```

3. Enter the **cfgSave** command to save the change to the defined configuration.

The **cfgSave** command ends and commits the current zoning transaction buffer to nonvolatile memory. If a transaction is open on a different switch in the fabric when this command is run, the transaction on the other switch is automatically aborted. A message displays on the other switches to indicate that the transaction was aborted.

### Example

```
switch:admin> cfgremove "NEW_cfg", "purplezone"
switch:admin> cfgsave
You are about to save the Defined zoning configuration. This
action will only save the changes on the Defined configuration.
Any changes made on the Effective configuration will not
take effect until it is re-enabled. Until the Effective
configuration is re-enabled, merging new switches into the
fabric is not recommended and may cause unpredictable
results with the potential of mismatched Effective Zoning
configurations.
Do you want to save Defined zoning configuration only? (yes, y, no, n): [no] y
```

### Enabling a zone configuration

The following procedure ends and commits the current zoning transaction buffer to nonvolatile memory. If a transaction is open on a different switch in the fabric when this procedure is run, the transaction on the other switch is automatically aborted. A message displays on the other switches to indicate that the transaction was aborted.

1. Connect to the switch and log in using an account with admin permissions.
2. Enter the **cfgenable** command, using the following syntax:

```
cfgenable "cfgname"
```

3. Enter **y** at the prompt.

### Example

```
switch:admin> cfgenable "USA_cfg"
You are about to enable a new zoning configuration.
This action will replace the old zoning configuration with the
current configuration selected. If the update includes changes
to one or more traffic isolation zones, the update may result in
localized disruption to traffic on ports associated with
the traffic isolation zone changes.
Do you want to enable 'USA_cfg' configuration (yes, y, no, n): [no] y
zone config "USA_cfg" is in effect
Updating flash ...
```

## Disabling a zone configuration

When you disable the current zone configuration, the fabric returns to non-zoning mode. All devices can then access each other or not, depending on the default zone access mode setting.

---

### NOTE

If the default zoning mode is set to All Access and more than 120 devices are connected to the fabric, you cannot disable the zone configuration because this would enable All Access mode and cause a large number of requests to the switch. In this situation, set the default zoning mode to No Access prior to disabling the zone configuration. See [“Default zoning mode”](#) on page 252 for information about setting this mode to No Access.

---

The following procedure ends and commits the current zoning transaction buffer to nonvolatile memory. If a transaction is open on a different switch in the fabric when this procedure is run, the transaction on the other switch is automatically aborted. A message displays on the other switches to indicate that the transaction was aborted.

1. Connect to the switch and log in using an account with admin permissions.
2. Enter the **cfgdisable** command, using the following syntax:

```
cfgdisable
```

3. Enter **y** at the prompt.

### Example

```
switch:admin> cfgdisable
You are about to disable zoning configuration. This
action will disable any previous zoning configuration enabled.
Do you want to disable zoning configuration? (yes, y, no, n): [no] y
```

## Deleting a zone configuration

1. Connect to the switch and log in using an account with admin permissions.
2. Enter the **cfgDelete** command, using the following syntax:

```
cfgdelete "cfgname"
```

3. Enter the **cfgSave** command to save the change to the defined configuration.

The **cfgSave** command ends and commits the current zoning transaction buffer to nonvolatile memory. If a transaction is open on a different switch in the fabric when this command is run, the transaction on the other switch is automatically aborted. A message displays on the other switches to indicate that the transaction was aborted.

# 11 Zone configurations

## Example

```
switch:admin> cfgdelete "testcfg"
switch:admin> cfgsave
You are about to save the Defined zoning configuration. This
action will only save the changes on the Defined configuration.
Any changes made on the Effective configuration will not
take effect until it is re-enabled. Until the Effective
configuration is re-enabled, merging new switches into the
fabric is not recommended and may cause unpredictable
results with the potential of mismatched Effective Zoning
configurations.
Do you want to save Defined zoning configuration only? (yes, y, no, n): [no] y
```

## Clearing changes to a configuration

- Enter the `cfgTransAbort` command.

When this command is executed, all changes since the last save operation (performed with the `cfgSave`, `cfgEnable`, or `cfgDisable` command) are cleared.

## Example

In the following example, assume that the removal of a member from **zone1** was done in error:

```
switch:admin> zoneremove "zone1", "3,5"
switch:admin> cfgtransabort
```

## Viewing all zone configuration information

If you do not specify an operand when executing the `cfgShow` command to view zone configurations, then all zone configuration information (both defined and effective) displays. If there is an outstanding transaction, then the newly edited zone configuration that has not yet been saved is displayed. If there are no outstanding transactions, then the committed zone configuration displays.

1. Connect to the switch and log in using an account with admin permissions.
2. Enter the `cfgShow` command with no operands.

## Example

```
switch:admin> cfgshow
Defined configuration:
  cfg:   USA1   Blue_zone
  cfg:   USA_cfg Purple_zone; Blue_zone
  zone:  Blue_zone
        1,1; array1; 1,2; array2
  zone:  Purple_zone
        1,0; loop1
  alias: array1  21:00:00:20:37:0c:76:8c; 21:00:00:20:37:0c:71:02
  alias: array2  21:00:00:20:37:0c:76:22; 21:00:00:20:37:0c:76:28
  alias: loop1   21:00:00:20:37:0c:76:85; 21:00:00:20:37:0c:71:df

Effective configuration:
  cfg:   USA_cfg
  zone:  Blue_zone
        1,1
        21:00:00:20:37:0c:76:8c
        21:00:00:20:37:0c:71:02
```



```

1,2
21:00:00:20:37:0c:76:22
21:00:00:20:37:0c:76:28
zone: Purple_zone
1,0
21:00:00:20:37:0c:76:85
21:00:00:20:37:0c:71:df

```

## Viewing selected zone configuration information

1. Connect to the switch and log in using an account with admin permissions.
2. Enter the **cfgShow** command and specify a pattern.

```
cfgshow "pattern" [, mode]
```

### Example

The following example displays all zone configurations that start with “Test”:

```

switch:admin> cfgshow "Test*"
cfg: Test1 Blue_zone
cfg: Test_cfg Purple_zone; Blue_zone

```

## Viewing the configuration in the effective zone database

1. Connect to the switch and log in using an account with admin permissions.
2. Enter the **cfgActvShow** command.

### Example

```

switch:admin> cfgactvshow
Effective configuration:
cfg: NEW_cfg
zone: Blue_zone
1,1
21:00:00:20:37:0c:76:8c
21:00:00:20:37:0c:71:02
1,2
21:00:00:20:37:0c:76:22
21:00:00:20:37:0c:76:28
zone: Purple_zone
1,0
21:00:00:20:37:0c:76:85
21:00:00:20:37:0c:71:df

```

## Clearing all zone configurations

1. Connect to the switch and log in using an account with admin permissions.
2. Enter the **cfgClear** command to clear all zone information in the transaction buffer.

---

### ATTENTION

Be careful using the **cfgClear** command because it deletes the defined configuration.

---

```

switch:admin> cfgclear
The Clear All action will clear all Aliases, Zones, FA Zones

```

## 11 Zone object maintenance

```
and configurations in the Defined configuration.  
Run cfgSave to commit the transaction or cfgTransAbort to  
cancel the transaction.  
Do you really want to clear all configurations? (yes, y, no, n): [no]
```

3. Enter one of the following commands, depending on whether an effective zone configuration exists:
  - If no effective zone configuration exists, enter the **cfgSave** command.
  - If an effective zone configuration exists, enter the **cfgDisable** command to disable and clear the zone configuration in nonvolatile memory for all switches in the fabric.

## Zone object maintenance

The following procedures describe how to copy, delete, and rename zone objects. Depending on the operation, a zone object can be a zone member, a zone alias, a zone, or a zone configuration.

### Copying a zone object

When you copy a zone object, the resulting object has the same name as the original. The zone object can be a zone configuration, a zone alias, or a zone.

1. Connect to the switch and log in using an account with admin permissions.
2. Enter the **cfgShow** command to view the zone configuration objects you want to copy.

```
cfgshow "pattern" [, mode]
```

For example, to display all zone configuration objects that start with "Test":

```
switch:admin> cfgshow "Test*"  
cfg:   Test1 Blue_zone  
cfg:   Test_cfg Purple_zone; Blue_zone
```

3. Enter the **zone --copy** command, specifying the zone objects you want to copy, along with the new object name. Note that zone configuration names are case-sensitive; blank spaces are ignored and it works in any Admin Domain other than AD255.

```
switch:admin> zone --copy Test1 US_Test1
```

4. Enter the **cfgShow** command to verify the new zone object is present.

```
switch:admin> cfgshow "Test*"  
cfg:   Test1 Blue_zone  
cfg:   Test_cfg Purple_zone; Blue_zone  
switch:admin> cfgShow "US_Test1"  
cfg:   US_Test1  
           Blue_zone
```

5. If you want the change preserved when the switch reboots, enter the **cfgSave** command to save it to nonvolatile (flash) memory.
6. Enter the **cfgEnable** command for the appropriate zone configuration to make the change effective.

## Deleting a zone object

The following procedure removes all references to a zone object and then deletes the zone object. The zone object can be a zone member, a zone alias, or a zone.

1. Connect to the switch and log in using an account with admin permissions.
2. Enter the **cfgShow** command to view the zone configuration objects you want to delete.

```
switch:admin> cfgShow
Defined configuration:
cfg: USA_cfg Purple_zone; White_zone; Blue_zone
zone: Blue_zone
      1,1; array1; 1,2; array2
zone: Purple_zone
      1,0; loop1
zone: White_zone
      1,3; 1,4
alias: array1 21:00:00:20:37:0c:76:8c; 21:00:00:20:37:0c:71:02
alias: array2 21:00:00:20:37:0c:76:22; 21:00:00:20:37:0c:76:28
alias: loop1 21:00:00:20:37:0c:76:85; 21:00:00:20:37:0c:71:df

Effective configuration:
cfg: USA_cfg
zone: Blue_zone
      1,1
      21:00:00:20:37:0c:76:8c
      21:00:00:20:37:0c:71:02
      1,2
      21:00:00:20:37:0c:76:22
      21:00:00:20:37:0c:76:28
zone: Purple_zone
      1,0
      21:00:00:20:37:0c:76:85
      21:00:00:20:37:0c:71:df
```

3. Enter the **zone --expunge** command to delete the zone object. Zone configuration names are case-sensitive; blank spaces are ignored and it works in any Admin Domain other than AD255.

```
switch:admin> zone --expunge "White_zone"
You are about to expunge one configuration
or member. This action could result in removing
many zoning configurations recursively.
[Removing the last member of a configuration removes the configuration.]
Do you want to expunge the member? (yes, y, no, n): [no] yes
```

4. Enter **yes** at the prompt.
5. Enter the **cfgShow** command to verify the deleted zone object is no longer present.
6. If you want the change preserved when the switch reboots, enter the **cfgSave** command to save it to nonvolatile (flash) memory.
7. Enter the **cfgEnable** command for the appropriate zone configuration to make the change effective.

### Renaming a zone object

1. Connect to the switch and log in using an account with admin permissions.
2. Enter the **cfgShow** command to view the zone configuration objects you want to rename.

```
switch:admin> cfgShow
Defined configuration:
cfg: USA_cfg Purple_zone; White_zone; Blue_zone
zone: Blue_zone
      1,1; array1; 1,2; array2
zone: Purple_zone
      1,0; loop1
zone: White_zone
      1,3; 1,4
alias: array1 21:00:00:20:37:0c:76:8c; 21:00:00:20:37:0c:71:02
alias: array2 21:00:00:20:37:0c:76:22; 21:00:00:20:37:0c:76:28
alias: loop1 21:00:00:20:37:0c:76:85; 21:00:00:20:37:0c:71:df
```

3. Enter the **zoneObjectRename** command to rename zone configuration objects. Note that zone configuration names are case-sensitive; blank spaces are ignored and it works in any Admin Domain other than AD255.

```
switch:admin> zoneObjectRename "White_zone", "Purple_zone"
```

4. Enter the **cfgShow** command to verify the renamed zone object is present.
5. If you want the change preserved when the switch reboots, enter the **cfgSave** command to save it to nonvolatile (flash) memory.
6. Enter the **cfgEnable** command for the appropriate zone configuration to make the change effective.

## Zone configuration management

You can add, delete, or remove individual elements in an existing zone configuration to create an appropriate configuration for your SAN environment. After the changes have been made, save the configuration to ensure the configuration is permanently saved in the switch and that the configuration is replicated throughout the fabric.

The switch configuration file can also be uploaded to the host for archiving and it can be downloaded from the host to a switch in the fabric. See [“Configuration file backup”](#) on page 180, [“Configuration file restoration”](#) on page 181, or the **configUpload** and **configDownload** commands in the *Fabric OS Command Reference* for additional information on uploading and downloading the configuration file.

## Security and zoning

Zones provide controlled access to fabric segments and establish barriers between operating environments. They isolate systems with different uses, protecting individual systems in a heterogeneous environment; for example, when zoning is in secure mode, no merge operations occur.

Brocade Advanced Zoning is configured on the primary fabric configuration server (FCS). The primary FCS switch makes zoning changes and other security-related changes. The primary FCS switch also distributes zoning to all other switches in the secure fabric. All existing interfaces can be used to administer zoning.

You must perform zone management operations from the primary FCS switch using a zone management interface, such as Telnet or Web Tools. You can alter a zone database, provided you are connected to the primary FCS switch.

When two secure fabrics join, the traditional zone merge does not occur. Instead, a zone database is downloaded from the primary FCS switch of the merged secure fabric. When E\_Ports are active between two switches, the name of the FCS server and a zoning policy set version identifier are exchanged between the switches. If the views of the two secure fabrics are the same, the fabric's primary FCS server downloads the zone database and security policy sets to each switch in the fabric. If there is a view conflict, the E\_Ports are segmented due to incompatible security data.

All zones should use frame-based hardware enforcement; the best way to do this is to use WWN identification exclusively for all zoning configurations.

## Zone merging

When a new switch is added to the fabric, it automatically takes on the zone configuration information from the fabric. You can verify the zone configuration on the switch using the procedure described in [“Viewing the configuration in the effective zone database”](#) on page 259.

If you are adding a switch that is already configured for zoning, clear the zone configuration on that switch before connecting it to the zoned fabric. See [“Clearing all zone configurations”](#) on page 259 for instructions.

Adding a new fabric that has no zone configuration information to an existing fabric is very similar to adding a new switch. All switches in the new fabric inherit the zone configuration data. If the existing fabric has an effective zone configuration, then the same configuration becomes the effective configuration for the new switches.

Before the new fabric can merge successfully, it must pass the following criteria:

- Before merging

To facilitate merging, check the following before merging switches or fabrics:

- **Default Zone:** The switches must adhere to the default zone merge rules, as described in [“Zone merging scenarios”](#) on page 265.
- **Effective and defined zone configuration match:** Ensure that the effective and defined zone configurations match. If they do not match, and you merge with another switch, the merge might be successful, but unpredictable zoning and routing behavior can occur.

- Merging and segmentation

The fabric is checked for segmentation during power-up, when a switch is disabled or enabled, or when a new switch is added.

The zone configuration database is stored in nonvolatile memory by the `cfgSave` command. All switches in the fabric have a copy of this database. When a change is made to the defined configuration, the switch where the changes were made must close its transaction for the change to be propagated throughout the fabric.

## 11 Zone merging

If you have implemented default zoning you must set the switch you are adding into the fabric to the same default zone mode setting as the rest of the fabric to avoid segmentation.

- Merging rules

Observe these rules when merging zones:

- Local and adjacent configurations: If the local and adjacent zone database configurations are the same, they will remain unchanged after the merge.
- Effective configurations: If there is an effective configuration between two switches, the effective zone configurations must match.
- Zone object naming: If a zoning object has the same name in both the local and adjacent defined configurations, the object types and member lists must match. When comparing member lists, the content and order of the members are important.
- Objects in adjacent configurations: If a zoning object appears in an adjacent defined configuration, but not in the local defined configuration, the zoning object is added to the local defined configuration. The modified zone database must fit in the nonvolatile memory area allotted for the zone database.
- Local configuration modification: If a local defined configuration is modified because of a merge, the new zone database is propagated to other the switches within the merge request.
- TI zones: If there is an effective configuration between two switches and TI zones are present on either switch, the TI zones are not automatically activated after the merge. Check the TI zone enabled status using the **zone --show** command and if the status does not match across switches, issue the **cfgenable** command.

- Merging two fabrics

Both fabrics have identical zones and configurations enabled, including the default zone mode. The two fabrics will join to make one larger fabric with the same zone configuration across the newly created fabric.

If the two fabrics have different zone configurations, they will not be merged. If the two fabrics cannot join, the ISL between the switches will segment.

- Merge conflicts

When a merge conflict is present, a merge will not take place and the ISL will segment. Use the **switchShow** or **errDump** commands to obtain additional information about possible merge conflicts, because many non-zone related configuration parameters can cause conflicts. See the *Fabric OS Command Reference* for detailed information about these commands.

If the fabrics have different zone configuration data, the system attempts to merge the two sets of zone configuration data. If the zones cannot merge, the ISL will be segmented.

A merge is not possible if any of the following conditions exist:

- Configuration mismatch: Zoning is enabled in both fabrics and the zone configurations that are enabled are different in each fabric.
- Type mismatch: The name of a zone object in one fabric is used for a different type of zone object in the other fabric.
- Content mismatch: The definition of a zone object in one fabric is different from the definition of zone object with the same name in the other fabric.
- Zone Database Size: If the zone database size exceeds the maximum limit of another switch.

**NOTE**

If the zoneset members on two switches are not listed in the same order, the configuration is considered a mismatch, resulting in the switches being segmented from the fabric. For example: `cfg1 = z1; z2` is different from `cfg1 = z2; z1`, even though members of the configuration are the same. If zoneset members on two switches have the same names defined in the configuration, make sure zoneset members are listed in the same order.

## Fabric segmentation and zoning

If the connections between two fabrics are no longer available, the fabric segments into two separate fabrics. Each new fabric retains the same zone configuration.

If the connections between two fabrics are replaced and no changes have been made to the zone configuration in either of the two fabrics, then the two fabrics merge back into one single fabric. If any changes that cause a conflict have been made to either zone configuration, then the fabrics might segment.

## Zone merging scenarios

The following tables provide information on merging zones and the expected results.

- [Table 52](#) on page 265: Defined and effective configurations
- [Table 53](#) on page 266: Different content
- [Table 54](#) on page 266: Different names
- [Table 55](#) on page 267: TI zones
- [Table 56](#) on page 267: Default access mode
- [Table 57](#) on page 268: Mixed Fabric OS versions

**TABLE 52** Zone merging scenarios: Defined and effective configurations

Description	Switch A	Switch B	Expected results
<b>Switch A</b> has a defined configuration. <b>Switch B</b> does not have a defined configuration.	defined: <code>cfg1</code> zone1: <code>ali1; ali2</code> effective: none	defined: none effective: none	Configuration from <b>Switch A</b> to propagate throughout the fabric in an inactive state, because the configuration is not enabled.
<b>Switch A</b> has a defined and effective configuration. <b>Switch B</b> has a defined configuration but no effective configuration.	defined: <code>cfg1</code> zone1: <code>ali1; ali2</code> effective: <code>cfg1</code>	defined: <code>cfg1</code> zone1: <code>ali1; ali2</code> effective: none	Configuration from <b>Switch A</b> to propagate throughout the fabric. The configuration is enabled after the merge in the fabric.
<b>Switch A</b> and <b>Switch B</b> have the same defined configuration. Neither have an effective configuration.	defined: <code>cfg1</code> zone1: <code>ali1; ali2</code> effective: none	defined: <code>cfg1</code> zone1: <code>ali1; ali2</code> effective: none	No change (clean merge).
<b>Switch A</b> and <b>Switch B</b> have the same defined and effective configuration.	defined: <code>cfg1</code> zone1: <code>ali1; ali2</code> effective: <code>cfg1</code>	defined: <code>cfg1</code> zone1: <code>ali1; ali2</code> effective: <code>cfg1</code>	No change (clean merge).
<b>Switch A</b> does not have a defined configuration. <b>Switch B</b> has a defined configuration.	defined: none effective: none	defined: <code>cfg1</code> zone1: <code>ali1; ali2</code> effective: none	<b>Switch A</b> will absorb the configuration from the fabric.

# 11 Zone merging

**TABLE 52 Zone merging scenarios: Defined and effective configurations (Continued)**

Description	Switch A	Switch B	Expected results
<b>Switch A</b> does not have a defined configuration. <b>Switch B</b> has a defined configuration.	defined: none effective: none	defined:cfg1 zone1: ali1; ali2 effective: cfg1	<b>Switch A</b> will absorb the configuration from the fabric, with cfg1 as the effective configuration.
<b>Switch A</b> and <b>Switch B</b> have the same defined configuration. Only <b>Switch B</b> has an effective configuration.	defined: cfg1 zone1: ali1; ali2 effective: none	defined: cfg1 zone1: ali1; ali2 effective: cfg1	Clean merge, with cfg1 as the effective configuration.
<b>Switch A</b> and <b>Switch B</b> have different defined configurations. Neither have an enabled zone configuration.	defined: cfg2 zone2: ali3; ali4 effective: none	defined: cfg1 zone1: ali1; ali2 effective: none	Clean merge. The new configuration will be a composite of the two. defined: cfg1 zone1: ali1; ali2 cfg2: zone2: ali3; ali4 effective: none
<b>Switch A</b> and <b>Switch B</b> have different defined configurations. <b>Switch B</b> has an effective configuration.	defined: cfg2 zone2: ali3; ali4 effective: none	defined: cfg1 zone1: ali1; ali2 effective: cfg1	Clean merge. The new configuration will be a composite of the two, with cfg1 as the effective configuration.
<b>Switch A</b> does not have a defined configuration. <b>Switch B</b> has a defined configuration and an effective configuration, but the effective configuration is different from the defined configuration.	defined: none effective: none	defined: cfg1 zone1: ali1; ali2 effective: cfg1 zone1: ali1; ali2 zone2: ali3, ali4	Clean merge. Switch A absorbs the defined configuration from the fabric, with cfg1 as the effective configuration. In this case, however, the effective configurations for Switch A and Switch B are different. You should issue a <b>cfgenable</b> from the switch with the proper effective configuration.

**TABLE 53 Zone merging scenarios: Different content**

Description	Switch A	Switch B	Expected results
Effective configuration mismatch.	defined: cfg1 zone1: ali1; ali2 effective: cfg1 zone1: ali1; ali2	defined: cfg2 zone2: ali3; ali4 effective: cfg2 zone2: ali3; ali4	Fabric segments due to: Zone Conflict cfg mismatch
Configuration content mismatch.	defined: cfg1 zone1: ali1; ali2 effective: irrelevant	defined: cfg1 zone1: ali3; ali4 effective: irrelevant	Fabric segments due to: Zone Conflict content mismatch

**TABLE 54 Zone merging scenarios: Different names**

Description	Switch A	Switch B	Expected results
Same content, different effective cfg name.	defined: cfg1 zone1: ali1; ali2 effective: cfg1 zone1: ali1; ali2	defined:cfg2 zone1: ali1; ali2 effective: cfg2 zone1: ali1; ali2	Fabric segments due to: Zone Conflict cfg mismatch
Same content, different zone name.	defined: cfg1 zone1: ali1; ali2 effective: irrelevant	defined: cfg1 zone2: ali1; ali2 effective: irrelevant	Fabric segments due to: Zone Conflict content mismatch



**TABLE 54 Zone merging scenarios: Different names (Continued)**

Description	Switch A	Switch B	Expected results
Same content, different alias name.	defined: cfg1 ali1: A; B effective: irrelevant	defined:cfg1 ali2: A; B effective: irrelevant	Fabric segments due to: Zone Conflict content mismatch
Same alias name, same content, different order.	defined: cfg1 ali1: A; B; C effective: irrelevant	defined: cfg1 ali1: B; C; A effective: irrelevant	Fabric segments due to: Zone Conflict content mismatch
Same name, different types.	effective: zone1: MARKETING	effective: cfg1: MARKETING	Fabric segments due to: Zone Conflict type mismatch
Same name, different types.	effective: zone1: MARKETING	effective: alias1: MARKETING	Fabric segments due to: Zone Conflict type mismatch
Same name, different types.	effective: cfg1: MARKETING	effective: alias1: MARKETING	Fabric segments due to: Zone Conflict type mismatch

**TABLE 55 Zone merging scenarios: TI zones**

Description	Switch A	Switch B	Expected results
<b>Switch A</b> does not have Traffic Isolation (TI) zones. <b>Switch B</b> has TI zones.	defined: cfg1 effective: cfg1	defined: cfg1 TI_zone1 effective: cfg1	Clean merge. TI zones are not automatically activated after the merge.
<b>Switch A</b> has TI zones. <b>Switch B</b> has identical TI zones.	defined: cfg1 TI_zone1 effective: cfg1	defined: cfg1 TI_zone1 effective: cfg1	Clean merge. TI zones are not automatically activated after the merge.
<b>Switch A</b> has a TI zone. <b>Switch B</b> has a different TI zone.	defined: cfg1 TI_zone1	defined: cfg1 TI_zone2	Fabric segments due to: Zone Conflict cfg mismatch. Cannot merge switches with different TI zone configurations.
Switch A has Enhanced TI zones. Switch B is running Fabric OS v6.4.0 or later.	defined: cfg1 TI_zone1 TI_zone2	defined: none	Clean merge. TI zones are not automatically activated after the merge.
Switch A has Enhanced TI zones. Switch B is running a Fabric OS version earlier than v6.4.0.	defined: cfg1 TI_zone1 TI_zone2	defined: none	Fabric segments because all switches in the fabric must be running Fabric OS v6.4.0 or later to support Enhanced TI zones.

**TABLE 56 Zone merging scenarios: Default access mode**

Description	Switch A	Switch B	Expected results
Different default zone access mode settings.	defzone: allaccess	defzone: noaccess	Clean merge – noaccess takes precedence and defzone configuration from <b>Switch B</b> propagates to fabric. defzone: noaccess
Same default zone access mode settings.	defzone: allaccess	defzone: allaccess	Clean merge – defzone configuration is allaccess in the fabric.
Same default zone access mode settings.	defzone: noaccess	defzone: noaccess	Clean merge – defzone configuration is noaccess in the fabric.

# 11 Zone merging

**TABLE 56 Zone merging scenarios: Default access mode (Continued)**

Description	Switch A	Switch B	Expected results
Effective zone configuration.	No effective configuration. defzone = allaccess	effective: cfg2 defzone: allaccess or noaccess	Clean merge – effective zone configuration and defzone mode from <b>Switch B</b> propagates to fabric.
Effective zone configuration.	No effective configuration. defzone = noaccess	effective: cfg2 defzone: allaccess	Fabric segments because <b>Switch A</b> has a hidden zone configuration (no access) activated and <b>Switch B</b> has an explicit zone configuration activated.
Effective zone configuration	effective: cfg1 defzone: noaccess	No effective configuration. defzone: noaccess	Clean merge – effective zone configuration from <b>Switch A</b> propagates to fabric.
Effective zone configuration	effective: cfg1 defzone: allaccess	No effective configuration. defzone: noaccess	Fabric segments. You can resolve the zone conflict by changing defzone to noaccess on <b>Switch 1</b> .

**TABLE 57 Zone merging scenarios: Mixed Fabric OS versions**

Description	Switch A	Switch B	Expected results
Switch A is running Fabric OS 7.0.0 or later. Switch B is running a Fabric OS version earlier than 7.0.0.	effective: cfg1 defzone = allaccess	No effective configuration. defzone - noaccess	Fabric segments due to zone conflict.
Switch A is running Fabric OS 7.0.0 or later. Switch B is running a Fabric OS version earlier than 7.0.0.	No effective configuration. defzone = noaccess	effective: cfg2 defzone - allaccess	Fabric segments due to zone conflict.

**NOTE**

When merging mixed versions of Fabric OS where both sides have default zone mode No Access set, the merge results vary depending on which switch initiates the merge.

# Traffic Isolation Zoning

---

## In this chapter

- Traffic Isolation Zoning overview ..... 269
- Enhanced TI zones ..... 274
- Traffic Isolation Zoning over FC routers ..... 276
- General rules for TI zones ..... 279
- Supported configurations for Traffic Isolation Zoning. .... 280
- Limitations and restrictions of Traffic Isolation Zoning. .... 281
- Admin Domain considerations for Traffic Isolation Zoning. .... 282
- Virtual Fabric considerations for Traffic Isolation Zoning. .... 282
- Traffic Isolation Zoning over FC routers with Virtual Fabrics ..... 284
- Creating a TI zone ..... 285
- Modifying TI zones ..... 288
- Changing the state of a TI zone ..... 289
- Deleting a TI zone ..... 290
- Displaying TI zones ..... 290
- Troubleshooting TI zone routing problems. .... 291
- Setting up TI over FCR (sample procedure) ..... 292

## Traffic Isolation Zoning overview

The Traffic Isolation Zoning feature allows you to control the flow of interswitch traffic by creating a dedicated path for traffic flowing from a specific set of source ports (N\_Ports). For example, you might use Traffic Isolation Zoning for the following scenarios:

- To dedicate an ISL to high priority, host-to-target traffic.
- To force high volume, low priority traffic onto a given ISL to limit the effect on the fabric of this high traffic pattern.
- To ensure that requests and responses of FCIP-based applications such as tape pipelining use the same VE\_Port tunnel across a metaSAN.

Traffic Isolation Zoning does not require a license.

Traffic isolation is implemented using a special zone, called a *Traffic Isolation zone* (TI zone). A TI zone indicates the set of N\_Ports and E\_Ports to be used for a specific traffic flow. When a TI zone is activated, the fabric attempts to isolate all inter-switch traffic entering from a member of the zone to only those E\_Ports that have been included in the zone. The fabric also attempts to exclude traffic not in the TI zone from using E\_Ports within that TI zone.

Figure 31 shows a fabric with a TI zone consisting of the following:

- N\_Ports: “1,7”, “1,8”, “4,5”, and “4,6”
- E\_Ports: “1,1”, “3,9”, “3,12”, and “4,7”

The dotted line indicates the dedicated path between the initiator in Domain 1 to the target in Domain 4.

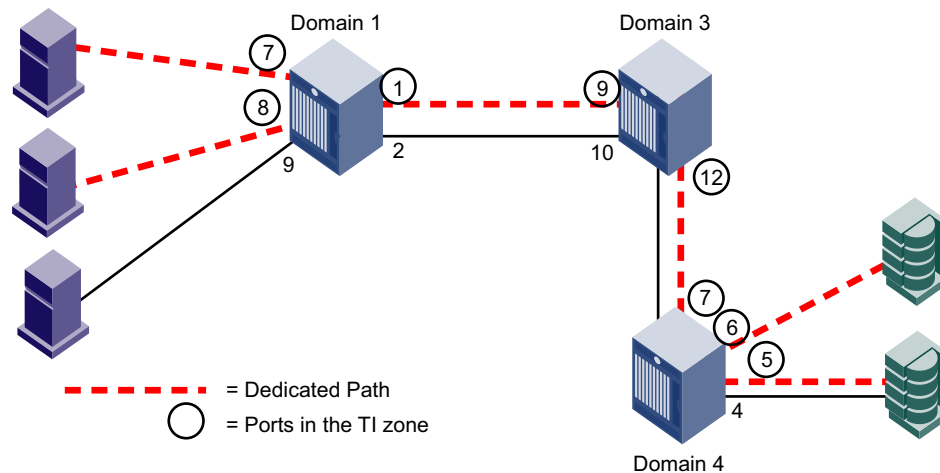

**FIGURE 31** Traffic Isolation zone creating a dedicated path through the fabric

In Figure 31, all traffic entering Domain 1 from N\_Ports 7 and 8 is routed through E\_Port 1. Similarly, traffic entering Domain 3 from E\_Port 9 is routed to E\_Port 12, and traffic entering Domain 4 from E\_Port 7 is routed to the devices through N\_Ports 5 and 6. Traffic coming from other ports in Domain 1 would *not* use E\_Port 1, but would use E\_Port 2 instead.

Use the **zone** command to create and manage TI zones. Refer to the *Fabric OS Command Reference* for details about the **zone** command.

## TI zone failover

A TI zone can have failover enabled or disabled.

Disable failover if you want to guarantee that TI zone traffic uses only the dedicated path, and that no other traffic can use the dedicated path.

Enable failover if you want traffic to have alternate routes if either the dedicated or non-dedicated paths cannot be used.

---

### ATTENTION

If failover is disabled, use care when planning your TI zones so that non-TI zone devices are not isolated. If this feature is not used correctly, it can cause major fabric disruptions that are difficult to resolve. See [“Additional considerations when disabling failover”](#) on page 271 for additional information about using this feature.

---

Table 58 on page 271 compares the behavior of traffic when failover is enabled and disabled.

**TABLE 58** Traffic behavior when failover is enabled or disabled in TI zones

Failover enabled	Failover disabled
If the dedicated path is not the shortest path or if the dedicated path is broken, the TI zone traffic will use a non-dedicated path instead.	If the dedicated path is not the shortest path or if the dedicated path is broken, traffic for that TI zone is halted until the dedicated path is fixed.
Non-TI zone traffic will use the dedicated path if no other paths through the fabric exist, or if the non-dedicated paths are not the shortest paths.	Non-TI zone traffic will never use the dedicated path, even if the dedicated path is the shortest path or if there are no other paths through the fabric.

For example, in [Figure 31](#) on page 270, if the dedicated ISL between Domain 1 and Domain 3 goes offline, then the following occurs, depending on the failover option:

- If failover is disabled for the TI zone, the TI zone traffic is halted until the ISL between Domain 1 and Domain 3 is back online.
- If failover is enabled for the TI zone, the TI zone traffic is routed from Domain 1 to Domain 3 through E\_Ports “1,2” and “3,10”.

**NOTE**

When TI zone traffic enters the non-TI path, the TI zone traffic continues to flow through that path. In this example, when the TI zone traffic is routed through E\_Ports “1,2” and “3,10”, that traffic continues through the non-TI path between domains 3 and 4, even though the TI path between domains 3 and 4 is not broken.

If the non-dedicated ISL between Domain 1 and Domain 3 goes offline, then the following occurs, depending on the failover option:

- If failover is disabled for the TI zone, non-TI zone traffic is halted until the non-dedicated ISL between Domain 1 and Domain 3 is back online.
- If failover is enabled for the TI zone, non-TI zone traffic is routed from Domain 1 to Domain 3 through the dedicated ISL.

**NOTE**

When non-TI zone traffic enters the TI path, the non-TI zone traffic continues to flow through that path. In this example, when the non-TI zone traffic is routed through E\_Ports “1,1” and “3,9”, that traffic continues through E\_Ports “3,12” and “4,7”, even though the non-dedicated ISL between domains 3 and 4 is not broken.

***Additional considerations when disabling failover***

If failover is disabled, be aware of the following considerations:

- This feature is intended for use in simple linear fabric configurations, such as that shown in [Figure 31](#) on page 270.
- Ensure that there are non-dedicated paths through the fabric for all devices that are not in a TI zone.
- If you create a TI zone with just E\_Ports, failover must be enabled. If failover is disabled, the specified ISLs will not be able to route any traffic.
- If the path between devices in a TI zone is broken, no inter-switch RSCNs are generated. Each switch that is part of the TI zone generates RSCNs to locally attached devices that are part of the TI zone and are registered to receive RSCNs.

- Ensure that there are multiple paths between switches.

Disabling failover locks the specified route so that only TI zone traffic can use it. Non-TI zone traffic is excluded from using the dedicated path.

- You should enable failover-enabled TI zones before enabling failover-disabled TI zones, to avoid dropped frames.

When you issue the **cfgEnable** command to enable the zone configuration, if you have failover disabled zones, do the following:

1. Temporarily change failover-disabled TI zones to failover-enabled.
2. Enable the zones (**cfgEnable**).
3. Reset all the zones you changed in [step 1](#) to failover-disabled.
4. Enable the zones again (**cfgEnable**).

These steps are listed in the procedures in this section.

- It is recommended that TI zone definitions and regular zone definitions match.
- Domain controller frames can use any path between switches. Disabling failover does not affect Domain Controller connectivity.

For example, in [Figure 32](#), if failover is disabled, Domain 2 can continue to send domain controller frames to Domain 3 and 4, even though the path between Domain 1 and Domain 3 is a dedicated path. Domain controller frames include zone updates and name server queries.

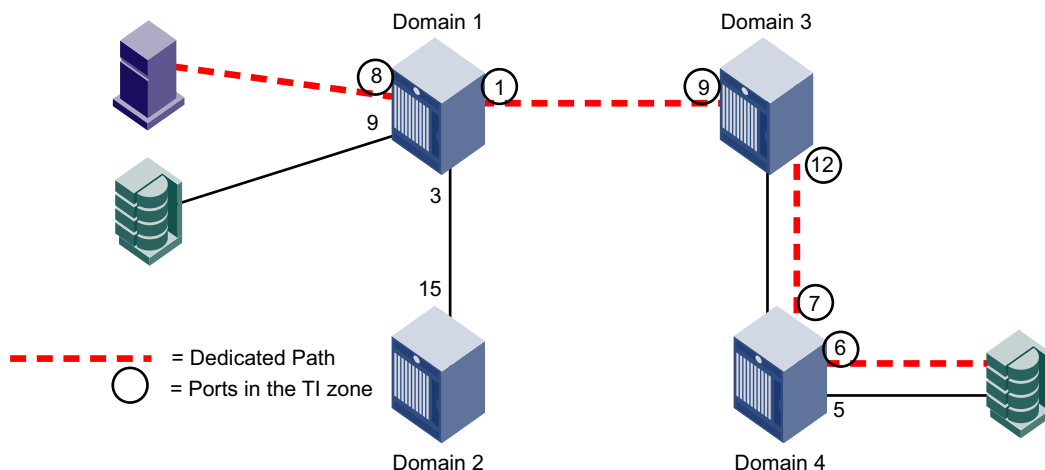

**FIGURE 32** Fabric incorrectly configured for TI zone with failover disabled

- It is recommended that the insistent Domain ID feature be enabled; if a switch changes its active domain ID, the route is broken. See the **configure** command in the *Fabric OS Command Reference* for information about setting insistent Domain ID.

## FSPF routing rules and traffic isolation

All traffic must use the lowest cost path. FSPF routing rules take precedence over the TI zones, as described in the following situations.

If the dedicated ISL is not the lowest cost path ISL, then the following rules apply:

- If failover is enabled, the traffic path for the TI zone is broken, and TI zone traffic uses the lowest cost path instead.
- If failover is disabled, the TI zone traffic is blocked.

If the dedicated ISL is the only lowest cost path ISL, then the following rules apply:

- If failover is enabled, non-TI zone traffic as well as TI zone traffic uses the dedicated ISL.
- If failover is disabled, non-TI zone traffic is blocked because it cannot use the dedicated ISL, which is the lowest cost path.

For example, in [Figure 33](#), there is a dedicated path between Domain 1 and Domain 3, and another, non-dedicated, path that passes through Domain 2. If failover is enabled, *all* traffic will use the dedicated path, because the non-dedicated path is not the shortest path. If failover is disabled, non-TI zone traffic is blocked because the non-dedicated path is not the shortest path.

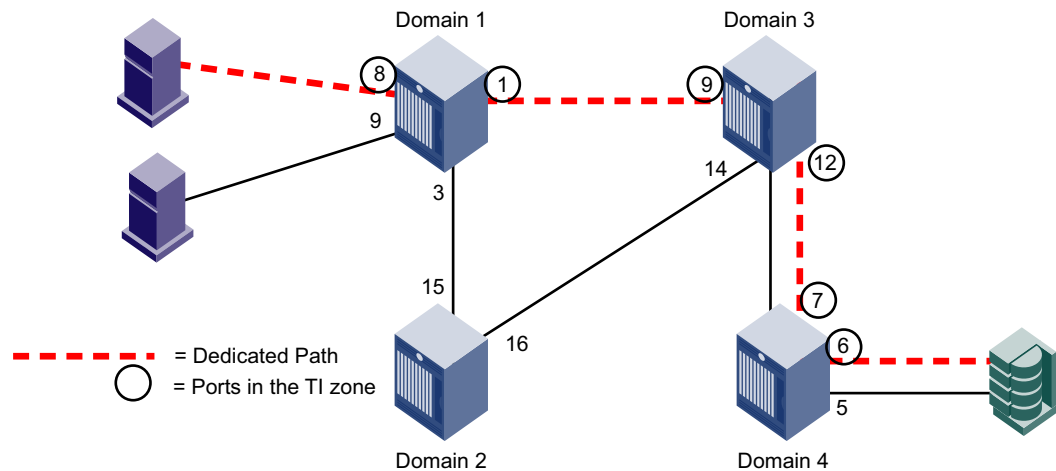

**FIGURE 33** Dedicated path is the only shortest path

In [Figure 34](#) on page 274, a dedicated path between Domain 1 and Domain 4 exists, but is not the shortest path. In this situation, if failover is enabled, the TI zone traffic uses the shortest path, even though the E\_Ports are not in the TI zone. If failover is disabled, the TI zone traffic stops until the dedicated path is configured to be the shortest path.

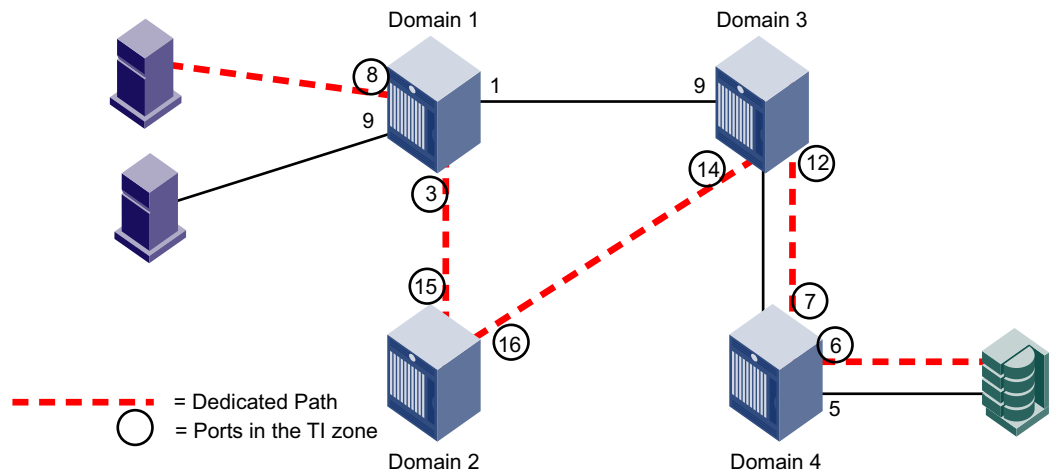

FIGURE 34 Dedicated path is not the shortest path

**NOTE**

For information about setting or displaying the FSPF cost of a path, see the `linkCost` and `topologyShow` commands in the *Fabric OS Command Reference*.

## Enhanced TI zones

Prior to Fabric OS v6.4.0, a port could be in only one TI zone at a time. Starting in Fabric OS v6.4.0, ports can be in multiple TI zones at the same time. Zones with overlapping port members are called *enhanced TI zones* (ETIZ).

Figure 35 shows an example of two TI zones. Because these TI zones have an overlapping port (3,8), they are enhanced TI zones.

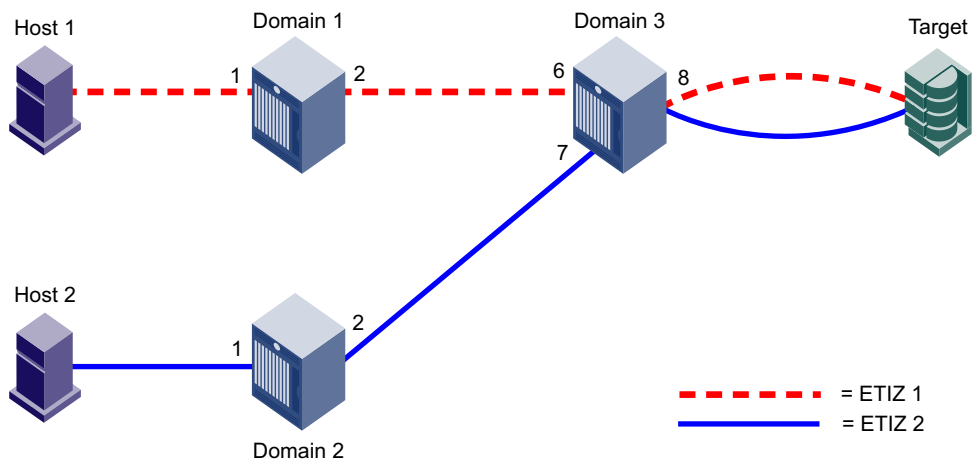

FIGURE 35 Enhanced TI zones

Enhanced TI zones are especially useful in FICON fabrics. See the *FICON Administrator's Guide* for example topologies using enhanced TI zones.

See “[Additional configuration rules for enhanced TI zones](#)” on page 281 for more information about enhanced TI zones.



## Illegal configurations with enhanced TI zones

When you create TI zones, ensure that all traffic from a port to all destinations on a remote domain have the same path. Do not create separate paths from a local port to two or more ports on the same remote domain.

If the TI zones are configured with failover disabled, some traffic will be dropped. If the TI zones are configured with failover enabled, all traffic will go through, but half of the traffic will be routed incorrectly according to the TI zone definitions.

A message is sent to the RASlog if a potential error condition is detected in the TIZ configuration. You can also display a report of existing and potential problems with TI zone configurations, as described in [“Troubleshooting TI zone routing problems”](#) on page 291.

### *Illegal ETIZ configuration: separate paths from a port to devices on same domain*

Figure 36 shows two enhanced TI zones that are configured incorrectly because there are two paths from a local port (port 8 on Domain 3) to two or more devices on the same remote domain (ports 1 and 4 on Domain 1).

The TI zones are enhanced TI zones because they have an overlapping member (3,8). Each zone describes a different path from the Target to Domain 1. Traffic is routed correctly from Host 1 and Host 2 to the Target; however, traffic from the Target to the Hosts might not be.

Traffic from (3,8) destined for Domain 1 cannot go through both port 6 and port 7, so only one port is chosen. If port 6 is chosen, frames destined for (1,4) will be dropped at Domain 1. If port 7 is chosen, frames destined for (1,1) will be dropped.

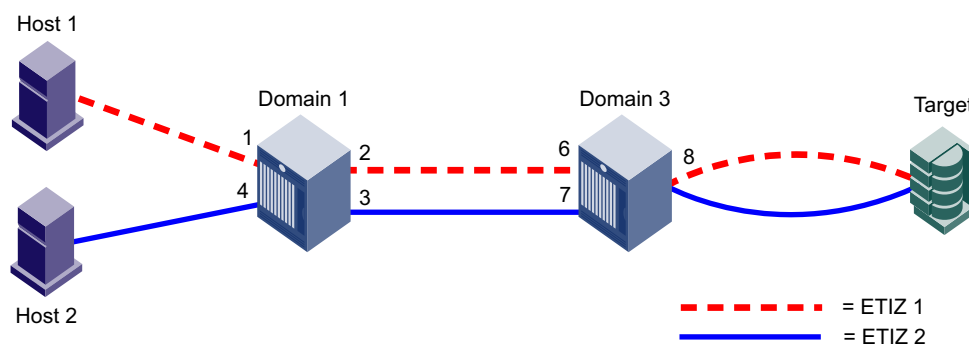

FIGURE 36 Illegal ETIZ configuration: two paths from one port to two devices on the same remote domain

### *Illegal ETIZ configuration: separate paths from a single port to the same domain*

Figure 37 shows another example of an illegal ETIZ configuration. In this example, the two hosts are on separate remote domains, but the path to each host goes through the same domain (Domain 1).

This example contains two enhanced TI zones, with port (3,8) as the overlapping member:

- ETIZ 1 contains (1,1), (1,2), (3,6), (3,8)
- ETIZ 2 contains (2,1), (2,2), (1,4), (1,3), (3,7), (3,8)

## 12 Traffic Isolation Zoning over FC routers

In this example traffic from the Target to Domain 2 is routed correctly. Only one TI zone describes a path to Domain 2. However, both TI zones describe different, valid paths from the Target to Domain 1. Only one path will be able to get to (1,1). Traffic from port (3,8) cannot be routed to Domain 1 over both (3,6) and (3,7), so one port will be chosen. If (3,7) is chosen, frames destined for (1,1) will be dropped at Domain 1.

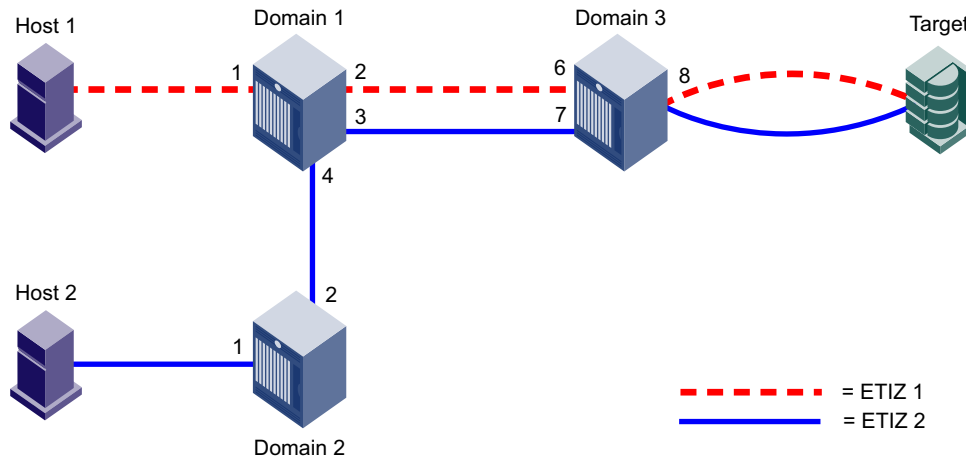

FIGURE 37 Illegal ETIZ configuration: two paths from one port

## Traffic Isolation Zoning over FC routers

This section describes how TI zones work with Fibre Channel routing (TI over FCR). See [Chapter 24, “Using FC-FC Routing to Connect Fabrics,”](#) for information about FC routers, phantom switches, and the FC-FC Routing Service.

Some VE\_Port-based features, such as tape pipelining, require the request and corresponding response traffic to traverse the same VE\_Port tunnel across the metaSAN. To ensure that the request and response traverse the same VE\_Port tunnel, you must set up Traffic Isolation zones in the edge and backbone fabrics.

- Set up a TI zone in an edge fabric to guarantee that traffic from a specific device in that edge fabric is routed through a particular EX\_Port or VEX\_Port.
- Set up a TI zone in the backbone fabric to guarantee that traffic between two devices in different fabrics is routed through a particular ISL (VE\_Ports or E\_Ports) in the backbone.

This combination of TI zones in the backbone and edge fabrics ensures that the traffic between devices in different fabrics traverses the same VE\_Port tunnel in a backbone fabric. [Figure 38](#) shows how three TI zones form a dedicated path between devices in different edge fabrics. The backbone fabric can contain one or more FC routers.

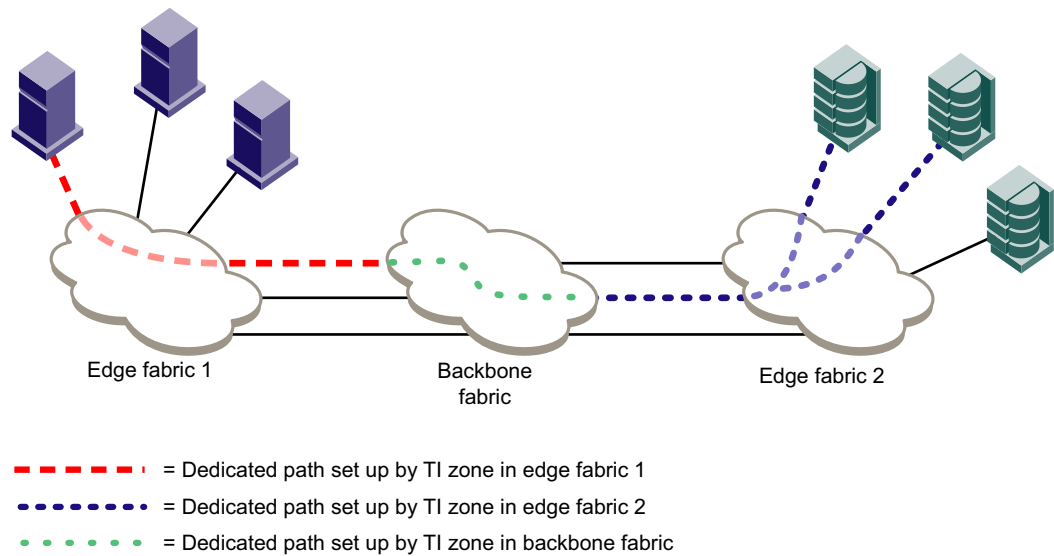

**FIGURE 38** Traffic Isolation Zoning over FCR

In addition to setting up TI zones, you must also ensure that the devices are in an LSAN zone so that they can communicate with each other.

If failover is enabled and the TI path is not available, an alternate path is used. If failover is disabled and the TI path is not available, then devices are not imported.

**NOTE**

For TI over FCR, all switches in the backbone fabric and in the edge fabrics must be running Fabric OS v6.1.0 or later.

### TI within an edge fabric

A TI zone within an edge fabric is used to route traffic between a real device and a proxy device through a particular EX\_Port. For example, in [Figure 39](#), you can set up a TI zone to ensure that traffic between Host 1 and the proxy target is routed through EX\_Port 9.

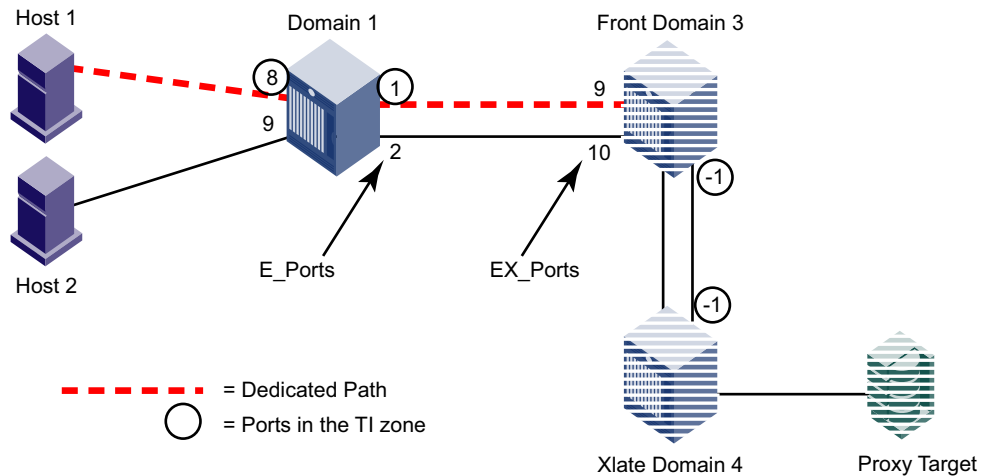

**FIGURE 39** TI zone in an edge fabric

In the TI zone, when you designate E\_Ports between the front and xlate phantom switches, you must use -1 in place of the “1” in the D,I notation. Both the front and xlate domains must be included in the TI zone.

Using D,I notation, the members of the TI zone in Figure 39 are:

- 1,8
- 1,1
- 3,-1 (E\_Port for the front phantom domain)
- 4,-1 (E\_Port for the xlate phantom domain)

Note that in this configuration the traffic between the front and xlate domains can go through any path between these two domains. The -1 does not identify any specific ISL. To guarantee a specific ISL, you need to set up a TI zone within the backbone fabric.

### TI within a backbone fabric

A TI zone within a backbone fabric is used to route traffic within the backbone fabric through a particular ISL. For example, in Figure 40, a TI zone is set up in the backbone fabric to ensure that traffic between EX\_Ports “1,1” and “2,1” is routed through VE\_Ports “1,4” and “2,7”.

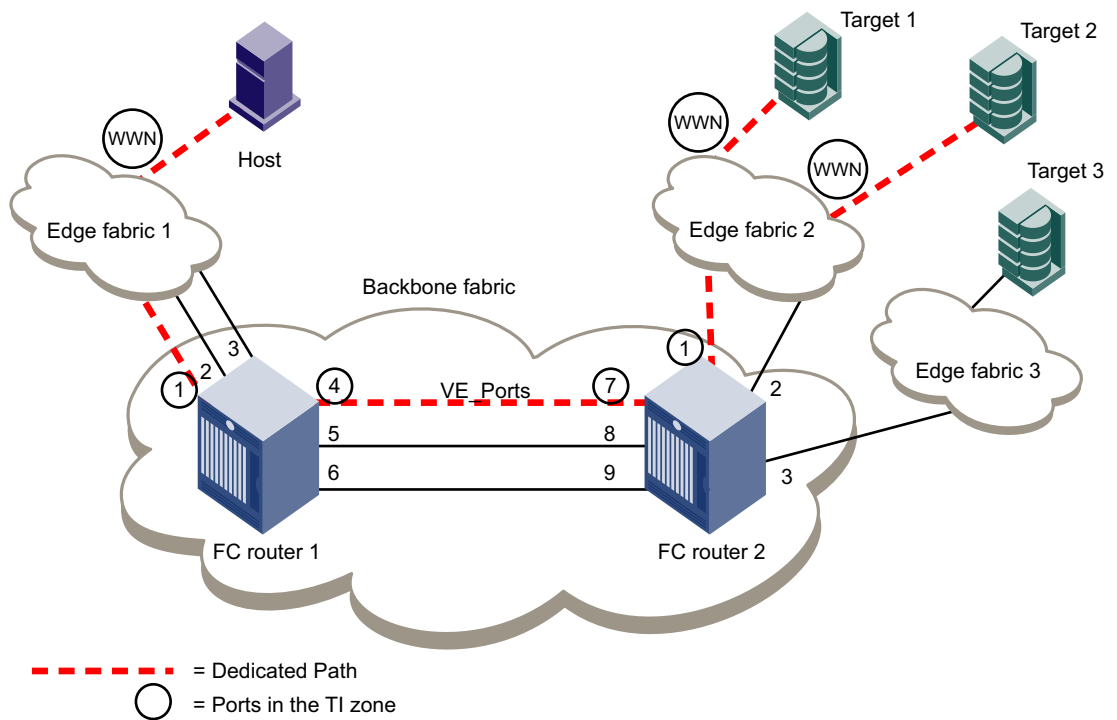

FIGURE 40 TI zone in a backbone fabric

TI zones within the backbone fabric use the port WWN instead of D,I notation for devices that are to communicate across fabrics. (You can use the **portShow** command to obtain the port WWN.) Port WWNs should be used only in TI zones within a backbone fabric and should not be used in other TI zones.

Using D,I and port WWN notation, the members of the TI zone in [Figure 40](#) are:

1,1	(EX_Port for FC router 1)
1,4	(VE_Port for FC router 1)
2,7	(VE_Port for FC router 2)
2,1	(EX_Port for FC router 2)
10:00:00:00:00:01:00:00	(Port WWN for the host)
10:00:00:00:00:02:00:00	(Port WWN for target 1)
10:00:00:00:00:03:00:00	(Port WWN for target 2)

## Limitations of TI zones over FC routers

Be aware of the following when configuring TI zones over FC routers:

- A TI zone defined within the backbone fabric does not guarantee that edge fabric traffic will arrive at a particular EX\_Port. You must set up a TI zone in the edge fabric to guarantee this.
- TI zones within the backbone fabric cannot contain more than one destination router port (DRP) per each fabric. This means you cannot define more than one EX\_Port to any one edge fabric unless they are part of a trunk.
- Only one egress E\_Port or VE\_Port connected to the next hop can be defined within TI zones. Only one ISL or trunk can be defined between two backbone switches.
- TI over FCR is supported only from edge fabric to edge fabric. Traffic isolation from backbone to edge is not supported.
- Non-TI data traffic is *not* restricted from going through the TI path in the backbone fabric.
- For TI over FCR, failover must be enabled in the TI zones in the edge fabrics and in the backbone fabric.
- TI over FCR is not supported with FC Fast Write.
- *For the FC8-16, FC8-32, FC8-48, FC8-64, and FX8-24 blades only:* If Virtual Fabrics is disabled, two or more shared area EX\_Ports connected to the same edge fabric should not be configured in different TI zones. This configuration is not supported.

## General rules for TI zones

Note the following general rules for TI zones:

- A TI zone must include E\_Ports and N\_Ports that form a complete, end-to-end route from initiator to target.
- When an E\_Port is a member of a TI zone that E\_Port cannot have its indexed swapped with another port.
- A given E\_Port used in a TI zone should not be a member of more than one TI zone.  
If multiple E\_Ports are configured that are on the lowest cost route to a domain, the various source ports for that zone are load-balanced across the specified E\_Ports.
- TI zones reside only in the defined configuration and not in the effective configuration. When you make any changes to TI zones, including creating or modifying them, you must enable the effective configuration for the changes to take effect, even if the effective configuration is unchanged.
- A TI zone only provides traffic isolation and is not a “regular” zone.

## 12 Supported configurations for Traffic Isolation Zoning

- Routing rules imposed by TI zones with failover disabled override regular zone definitions. Regular zone definitions should match TI zone definitions.
- FSPF supports a maximum of 16 paths to a given domain. This includes paths in a TI zone.
- Each TI zone is interpreted by each switch and each switch considers only the routing required for its local ports. No consideration is given to the overall topology and to whether the TI zones accurately provide dedicated paths through the whole fabric.

For example, in [Figure 41](#), the TI zone was configured incorrectly and E\_Port “3,9” was erroneously omitted from the zone. The domain 3 switch assumes that traffic coming from E\_Port 9 is *not* part of the TI zone and so that traffic is routed to E\_Port 11 instead of E\_Port 12, if failover is enabled. If failover is disabled, the route is broken and traffic stops.

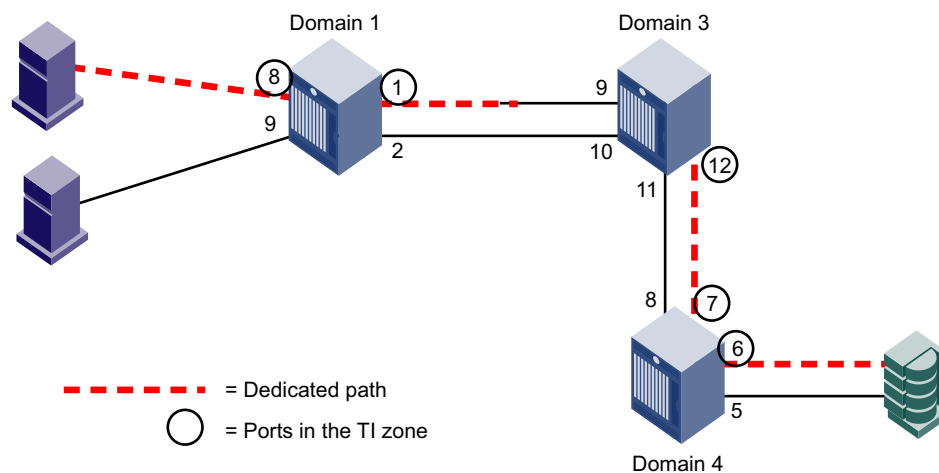

FIGURE 41 TI zone misconfiguration

## Supported configurations for Traffic Isolation Zoning

Note the following configuration rules for TI zones:

- Ports in a TI zone must belong to switches that run Fabric OS v6.0.0 or later. For TI over FCR zones, all switches and FC routers in both edge and backbone fabrics must be running Fabric OS v6.1.0 or later.
- For the FC8-64 blade in the Brocade DCX and DCX 8510-8, ports 48–63 can be in a TI zone only if all switches in that TI zone are running Fabric OS v6.4.0 or later. Ports 48–63 can still be in a failover path for TI traffic.

The Brocade DCX-4S and DCX 8510-4 do not have this limitation.

- VE\_Ports are supported in TI zones.
- TI Zoning is not supported in fabrics with switches running firmware versions earlier than Fabric OS v6.0.0. However, the existence of a TI zone in such a fabric is backward-compatible and does not disrupt fabric operation in switches running earlier firmware versions.

TI over FCR is not backward compatible with Fabric OS v6.0.x or earlier. The -1 in the *domain,index* entries causes issues to legacy switches in a zone merge. Firmware downgrade is prevented if TI over FCR zones exist.

## Additional configuration rules for enhanced TI zones

Enhanced TI zones (ETIZ) have the following additional configuration rules:

- Enhanced TI zones are supported only if every switch in the fabric is ETIZ capable. A switch is ETIZ capable if it meets the following qualifications:
  - The switch must be one of the supported platforms, as listed in [“Supported hardware and software”](#) on page xxxiv.
  - The switch must be running Fabric OS v6.4.0 or later.
- If the fabric contains a switch running an earlier version of Fabric OS, you cannot create an enhanced TI zone. You cannot merge a downlevel switch into a fabric containing enhanced TI zones, and you cannot merge a switch with enhanced TI zones defined into a fabric containing switches that do not support ETIZ.
- Overlapping TI zones must have the same failover type. That is, both must be either failover enabled or failover disabled.

---

### NOTE

FC router domains are excluded from the ETIZ platform restrictions. You can create enhanced TI zones with these switches in the fabric.

---

## Trunking with TI zones

Note the following if you implement trunking and TI zones:

- To include a trunk group in a TI zone, you must include all ports of the trunk in the TI zone.
- Trunked ISL ports cannot be members of more than one TI zone.

## Limitations and restrictions of Traffic Isolation Zoning

- For switches running Fabric OS 6.1.0 or later, a maximum of 255 TI zones can be created in one fabric. For switches running Fabric OS 6.0.x, no more than 239 TI zones should be created.

A fabric merge resulting in greater than the maximum allowed TI zones results in merge failure and the fabrics are segmented.
- A TI zone can be created using D,I (Domain, Index) notation only, except for TI zones in a backbone fabric, which use port WWNs. See [“Traffic Isolation Zoning over FC routers”](#) on page 276 for information about TI zones in a backbone fabric.
- To include a trunk group in a TI zone, you must include all ports of the trunk in the TI zone.
- Two N\_Ports that have the same shared area should not be configured in different TI zones. This limitation does not apply to E\_Ports that use the same shared area on the FC4-48 and FC8-48 port blades.
- Ports that are in different TI zones cannot communicate with each other if failover is disabled.
- TI zone members that overlap must have the same TI failover policy across all TI zones to which they belong. That is, if an overlapping member is part of a failover-disabled zone, then it can belong only to other TI zones where the policy is also failover-disabled; the member cannot overlap with failover-enabled TI zones.

- TI zones that have members with port index greater than 511 are not supported with Fabric OS versions earlier than v6.4.0. If such a TI zone and Fabric OS version combination is detected, a warning is issued. These configurations are not prevented, but their behavior is unpredictable.
- When you merge two switches, if there is an effective configuration on the switches and TI zones are present on either switch, the TI zones are not automatically activated after the merge. Check the TI zone enabled status using the `zone --show` command, and if the TI Zone Enabled status does not match across switches, issue the `cfgEnable` command.
- Use care when creating TI zones on ICL ports in topologies that span more than two switches connected with ICLs. If a user-defined TI zone breaks the ICL connectivity requirements, a RASlog message is generated to notify you of this error condition.

## Admin Domain considerations for Traffic Isolation Zoning

Note the following if you implement Admin Domains and TI zones:

- TI zones are applicable only in ADO, and the E\_Ports that are members of a TI zone must be in the ADO device list. Because TI zones must use D,I notation, the ADO device list must be declared using D,I notation for ports that are to be used in TI zones.
- A port used in a TI zone should not be a member of multiple Admin Domains.
- Use care if defining TI zones with ports that are shared across Admin Domains because of the limitation that a given port can appear in only one TI zone.  
**Best practice:** Do not use ports that are shared across Admin Domains in a TI zone.

## Virtual Fabric considerations for Traffic Isolation Zoning

This section describes how TI zones work with Virtual Fabrics. See [Chapter 10, “Managing Virtual Fabrics,”](#) for information about the Virtual Fabrics feature, including logical switches and logical fabrics.

TI zones can be created in a logical fabric like in regular fabrics, with the following exceptions:

- The disable failover option is not supported in logical fabrics that use XISLs.  
Although logical switches that use XISLs allow the creation of a TI zone with failover disabled, this is not a supported configuration. Base switches do not allow the creation of a TI zone with failover disabled.
- To create a TI zone for a logical fabric that uses XISLs, you must create two TI zones: one in the logical fabric and one in the base fabric. The combination of TI zones in the base fabric and logical fabric sets the path through the base fabric for logical switches.

The TI zone in the logical fabric includes the extended XISL (XISL) port numbers, as well as the F\_Ports and ISLs in the logical fabric.

The TI zone in the base fabric reserves XISLs for a particular logical fabric. The base fabric TI zone should also include ISLs that belong to logical switches participating in the logical fabric.

[Figure 42](#) shows an initiator and target in a logical fabric (FID1). The dotted line indicates a dedicated path between initiator and target. The dedicated path passes through the base fabric over an XISL. ([Figure 42](#) shows only physical ISLs, not logical ISLs.) To create the TI zones for this dedicated path, you must create a TI zone in the logical fabric (FID 1) and one in the base fabric.



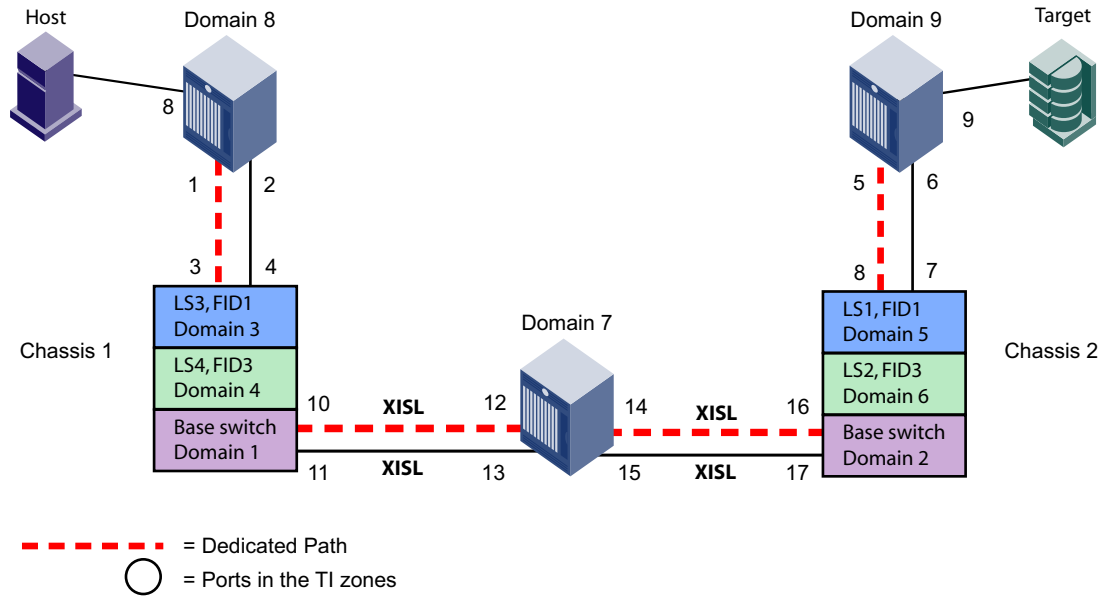

**FIGURE 42** Dedicated path with Virtual Fabrics

Figure 43 shows a logical representation of FID1 in Figure 42. To create the dedicated path, you must create and activate a TI zone in FID1 that includes the circled ports shown in Figure 43.

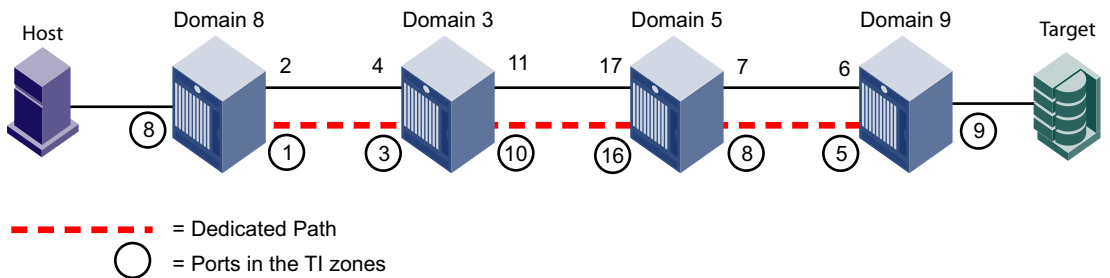

**FIGURE 43** Creating a TI zone in a logical fabric

You must also create and activate a TI zone in the base fabric to reserve the XISLs for the dedicated path. In Figure 44, the XISLs highlighted (by a dotted line) in the base fabric can be reserved for FID1 by defining and activating a base fabric TI zone that consists of ports 10, 12, 14, and 16. You must also include ports 3 and 8, because they belong to logical switches participating in the logical fabric. For the TI zone, it is as though ports 3 and 8 belong to Domains 1 and 2 respectively.

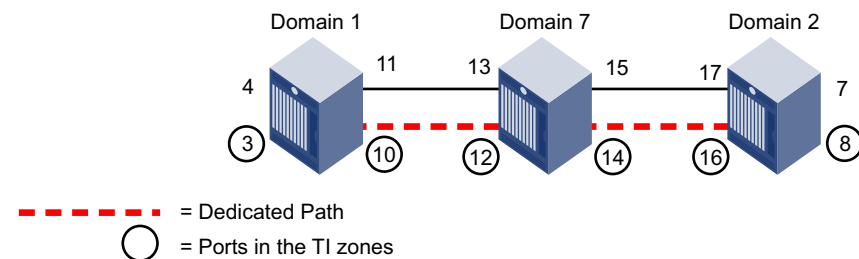

**FIGURE 44** Creating a TI zone in a base fabric

## 12 Traffic Isolation Zoning over FC routers with Virtual Fabrics

Using D,I notation, the port numbers for the TI zones in the logical fabric and base fabric are as follows:

### Port members for the TI zone in logical fabric

8,8	F_Port
8,1	E_Port
3,3	E_Port
3,10	E_Port
5,16	E_Port
5,8	E_Port
9,5	E_Port
9,9	F_Port

### Port members for the TI zone in base fabric

1,3	E_Port for ISL in logical switch
1,10	E_Port for XISL
7,12	E_Port for XISL
7,14	E_Port for XISL
2,16	E_Port for XISL
2,8	E_Port for ISL in logical switch

Note that the base fabric zone contains a reference to port 1,3 even though the base switch with domain 1 does not have a port 3 in the switch. This number refers to the port in the chassis with port index 3, which actually belongs to LS3 in FID 1.

## Traffic Isolation Zoning over FC routers with Virtual Fabrics

This section describes how you can set up TI zones over FC routers in logical fabrics. [Figure 45](#) shows two physical chassis configured into logical switches. The initiator in FID 1 communicates with the target in FID 3 over the EX\_Ports in the base switches.

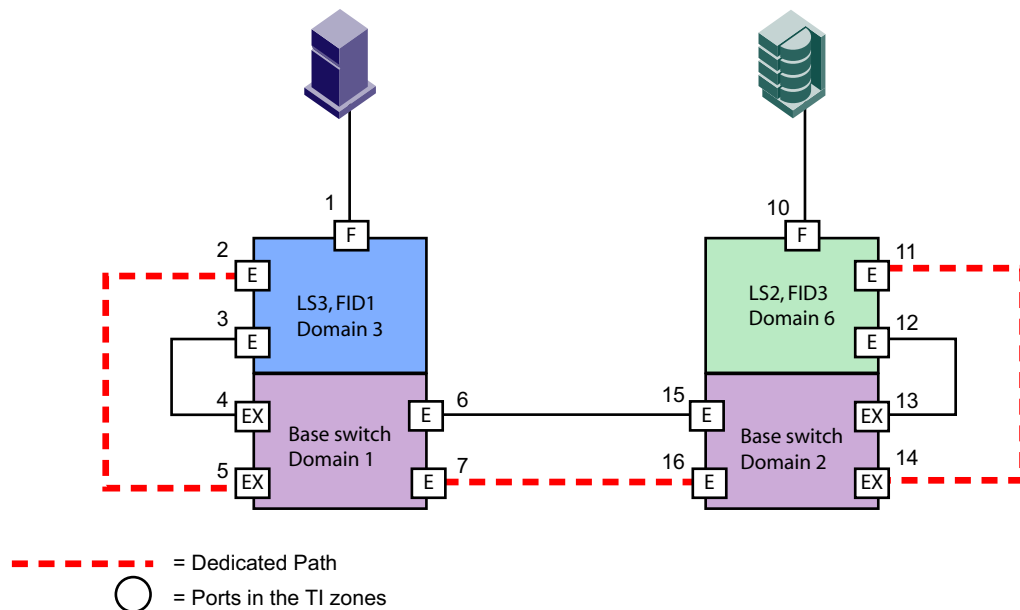

**FIGURE 45** Example configuration for TI zones over FC routers in logical fabrics

[Figure 46](#) shows a logical representation of the configuration in [Figure 45](#). This SAN is similar to that shown in [Figure 38](#) on page 277 and you would set up the TI zones in the same way as described in “[Traffic Isolation Zoning over FC routers](#)” on page 276.

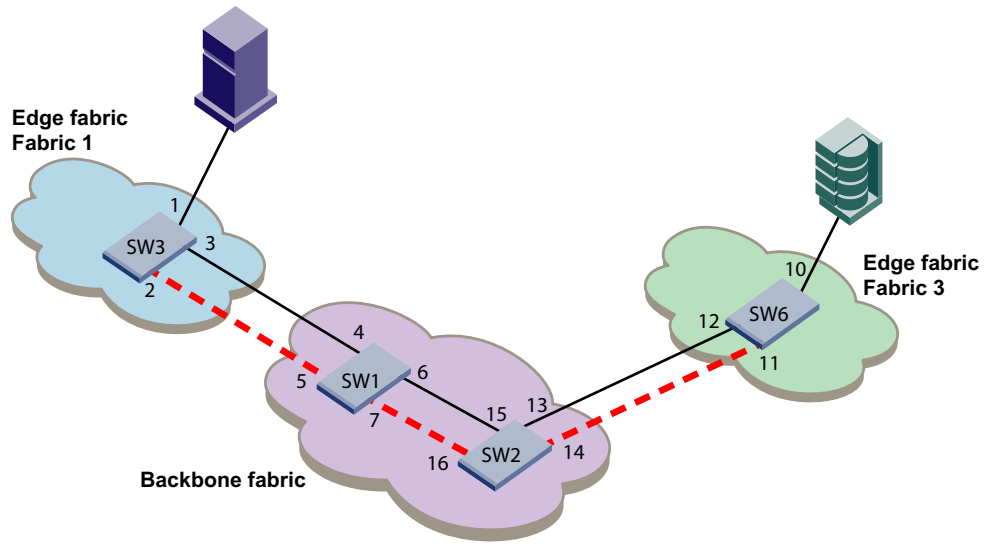

FIGURE 46 Logical representation of TI zones over FC routers in logical fabrics

## Creating a TI zone

You create and modify TI zones using the **zone** command. Other zoning commands, such as **zoneCreate**, **aliCreate**, and **cfgCreate**, cannot be used to manage TI zones.

When you create a TI zone, you can set the state of the zone to activated or deactivated. By default the zone state is set to activated; however, this does not mean that the zone is activated. After you create the TI zone, you must enable the current effective configuration to enforce the new TI zone, which is either activated or deactivated.

**Virtual Fabric considerations:** Because base fabrics do not contain end devices, they normally do not have an effective zone configuration. To activate a TI zone in a base fabric, you should create a "dummy" configuration, as described in [“Creating a TI zone in a base fabric”](#) on page 287.

When you create a TI zone, you can enable or disable failover mode. By default, failover mode is enabled. If you want to change the failover mode after you create the zone, see [“Modifying TI zones”](#) on page 288.

If you are creating a TI zone with failover disabled, note the following:

- Ensure that the E\_Ports of the TI zone correspond to valid paths; otherwise, the route might be missing for ports in that TI zone. You can use the **topologyShow** command to verify the paths.
- Ensure that sufficient non-dedicated paths through the fabric exist for all devices that are not in a TI zone; otherwise, these devices might become isolated.

See [“TI zone failover”](#) on page 270 for information about disabling failover mode.

Use the following procedure to create a TI zone. If you are creating a TI zone in a base fabric, use the procedure described in [“Creating a TI zone in a base fabric”](#) on page 287.

1. Connect to the switch and log in using an account with admin permissions.
2. Enter the **zone --create** command:

```
zone --create -t objtype [-o optlist] name -p "portlist"
```

## 12 Creating a TI zone

Be aware of the ramifications if you create a TI zone with failover mode disabled. See “[TI zone failover](#)” on page 270 for information about disabling failover mode.

3. Perform the following steps if you have any TI zones with failover disabled. If all of your TI zones are failover-enabled, skip to [step 4](#).

- a. Change the failover option to failover enabled. This is a temporary change to avoid frame loss during the transition.

```
zone --add -o f name
```

- b. Enable the zones.

```
cfgenable "current_effective_configuration"
```

- c. Reset the failover option to failover disabled. Then continue with [step 4](#).

```
zone --add -o n name
```

4. Enter the **cfgEnable** command to reactivate your current effective configuration and enforce the TI zones.

```
cfgenable "current_effective_configuration"
```

### Example of creating a TI zone

The following examples create a TI zone named “bluezone”, which contains E\_Ports 1,1 and 2,4 and N\_Ports 1,8 and 2,6.

To create a TI zone with failover enabled and in the activated state (default settings):

```
switch:admin> zone --create -t ti bluezone -p "1,1; 2,4; 1,8; 2,6"
```

To create a TI zone with failover enabled (the zone is set to the activated state by default):

```
switch:admin> zone --create -t ti -o f bluezone -p "1,1; 2,4; 1,8; 2,6"
```

To create a TI zone with failover disabled and the state set to activated:

```
switch:admin> zone --create -t ti -o an bluezone -p "1,1; 2,4; 1,8; 2,6"
```

To create a TI zone and set the state to deactivated (failover is enabled by default):

```
switch:admin> zone --create -t ti -o d bluezone -p "1,1; 2,4; 1,8; 2,6"
```

To create a TI zone with failover disabled and the state set to deactivated:

```
switch:admin> zone --create -t ti -o dn bluezone -p "1,1; 2,4; 1,8; 2,6"
```

To create a TI zone in the edge fabric with failover enabled and the state set to activated (default settings):

```
switch:admin> zone --create -t ti bluezone -p "1,1; 1,8; 2,-1; 3,-1"
```

To create a TI zone in the backbone fabric with failover enabled and the state set to activated (default settings):

```
switch:admin> zone --create -t ti backbonezone -p "10:00:00:04:1f:03:16:f2;  
1,1; 1,4; 2,7; 2,1; 10:00:00:04:1f:03:18:f1, 10:00:00:04:1f:04:06:e2"
```

To create TI zones in a logical fabric, such as the one shown in [Figure 43](#) on page 283:

Log in to the logical switch FID1, Domain 7 and create a TI zone in the logical fabric with FID=1:

```
LS1> zone --create -t ti -o f "ti_zone1" -p "8,8; 8,1; 3,3; 3,10; 5,16; 5,8;
9,5; 9,9"
```

Then create a TI zone in the base fabric, as described in [“Creating a TI zone in a base fabric”](#).

Remember that your changes are not enforced until you enter the **cfgEnable** command, as shown here:

```
switch:admin> cfgenable "USA_cfg"
You are about to enable a new zoning configuration.
This action will replace the old zoning configuration with the
current configuration selected.
If the update includes changes to one or more traffic isolation zones, the
update may result in localized disruption to traffic on ports associated with
the traffic isolation zone changes
Do you want to enable 'USA_cfg' configuration (yes, y, no, n): [no] y
zone config "USA_cfg" is in effect
Updating flash ...
```

## Creating a TI zone in a base fabric

1. Connect to the switch and log in using an account with admin permissions.
2. Create a “dummy” zone configuration in the base fabric. For example:

```
zone --create "z1", "1,1"
cfgcreate "base_config", z1
```

3. Enter the **zone --create** command to create the TI zone in the base fabric:

```
zone --create -t objtype -o f name -p "portlist"
```

The disable failover option is not supported in base fabrics.

4. Perform the following steps if you have any TI zones with failover disabled. If all of your TI zones are failover-enabled, skip to [step 5](#).

- a. Change the failover option to failover enabled. This is a temporary change to avoid frame loss during the transition.

```
zone --add -o f name
```

- b. Enable the zones.

```
cfgenable "current_effective_configuration"
```

- c. Reset the failover option to failover disabled. Then continue with [step 4](#).

```
zone --add -o n name
```

5. Enter the **cfgEnable** command to reactivate your current effective configuration and enforce the TI zones.

```
cfgenable "base_config"
```

**Example**

The following example creates TI zones in the base fabric shown in [Figure 44](#) on page 283:

```
BS_D1> zonecreate "z1", "1,1"
BS_D1> cfgcreate "base_cfg", z1
BS_D1> zone --create -t ti -o f "ti_zone2" -p "1,3; 1,10; 7,12; 7,14; 2,16;
2,8"
BS_D1> cfgenable "base_config"
```

## Modifying TI zones

Using the **zone --add** command, you can add ports to an existing TI zone, change the failover option, or both. You can also activate or deactivate the TI zone.

Using the **zone --remove** command, you can remove ports from existing TI zones. If you remove the last member of a TI zone, the TI zone is deleted.

After you modify the TI zone, you must enable the current effective configuration to enforce the changes.

**ATTENTION**

If failover is disabled, do not allocate all ISLs in TI zones. Make sure sufficient non-dedicated paths exist through the fabric for all devices that are not in a TI zone. See [“TI zone failover”](#) on page 270 for additional information about disabling failover mode.

**NOTE**

If you have overlapping TI zones and you want to change the failover option on these zones, you must first remove the overlapping ports from the zones, then change the failover type, and finally re-add the overlapping members.

1. Connect to the switch and log in using an account with admin permissions.
2. Enter one of the following commands, depending on how you want to modify the TI zone.
  - Enter the **zone --add** command to add ports or change the failover option for an existing TI zone. You can also activate or deactivate the zone.

```
zone --add [-o optlist] name -p "portlist"
```

```
zone --add -o optlist name [-p "portlist"]
```

- Enter the **zone --remove** command to remove ports from an existing TI zone.

```
zone --remove name -p "portlist"
```

Be aware of the ramifications if you disable failover mode. See [“TI zone failover”](#) on page 270 for information about disabling failover mode.

3. Perform the following steps if you have any TI zones with failover disabled. If all of your TI zones are failover-enabled, skip to [step 4](#).
  - a. Change the failover option to failover enabled. This is a temporary change to avoid frame loss during the transition.

```
zone --add -o f name
```

- b. Enable the zones.

```
cfgenable "current_effective_configuration"
```

- c. Reset the failover option to failover disabled. Then continue with [step 4](#).

```
zone --add -o n name
```

4. Enter the **cfgEnable** command to reactivate your current effective configuration and enforce the TI zones.

```
cfgenable "current_effective_configuration"
```

#### Example of modifying a TI zone

To add port members to the existing TI zone bluezone:

```
switch:admin> zone --add bluezone -p "3,4; 3,6"
```

To add port members to the existing TI zone in a backbone fabric:

```
switch:admin> zone --add backbonezone -p "3,4; 3,6; 10:00:00:04:1f:03:16:f2;"
```

To disable failover on the existing TI zone bluezone:

```
switch:admin> zone --add -o n bluezone
```

To enable failover and add ports to TI zone greenzone:

```
switch:admin> zone --add -o f greenzone -p "3,4"
```

To remove ports from the TI zone bluezone:

```
switch:admin> zone --remove bluezone -p "3,4; 3,6"
```

Remember that your changes are not enforced until you enter the **cfgEnable** command.

## Changing the state of a TI zone

You can change the state of a TI zone to activated or deactivated. Changing the state does not activate or deactivate the zone. After you change the state of the TI zone, you must enable the current effective configuration to enforce the change.

The TI zone must exist before you can change its state.

1. Connect to the switch and log in using an account with admin permissions.
2. Perform one of the following actions:
  - To activate a TI zone, enter the **zone --activate** command.
 

```
zone --activate name
```
  - To deactivate a TI zone, enter the **zone --deactivate** command.
 

```
zone --deactivate name
```
3. Enter the **cfgEnable** command to reactivate your current effective configuration and enforce the TI zones.

```
cfgenable "current_effective_configuration"
```

## 12 Deleting a TI zone

### Example of setting the state of a TI zone

To change the state of the existing TI zone bluezone to activated, type:

```
switch:admin> zone --activate bluezone
```

To change the state of the existing TI zone greenzone to deactivated, type:

```
switch:admin> zone --deactivate greenzone
```

Remember that your changes are not enforced until you enter the **cfgEnable** command.

## Deleting a TI zone

Use the **zone --delete** command to delete a TI zone from the defined configuration. This command deletes the entire zone; to only remove port members from a TI zone, use the **zone --remove** command, as described in “Modifying TI zones” on page 288.

1. Connect to the switch and log in using an account with admin permissions.
2. Enter the **zone --delete** command.

```
zone --delete name
```

You can delete multiple zones by separating the zone names with a semicolon and enclosing them in quotation marks.

3. Enter the **cfgEnable** command to reactivate your current effective configuration and enforce the TI zones.

```
cfgenable "current_effective_configuration"
```

### Example of deleting a TI zone

To delete the TI zone bluezone, type:

```
switch:admin> zone --delete bluezone
```

Remember that your changes are not enforced until you enter the **cfgEnable** command.

## Displaying TI zones

Use the **zone --show** command to display information about TI zones. This command displays the following information for each zone:

- Zone name
- E\_Port members
- N\_Port members
- Configured status (the latest status, which may or may not have been activated by **cfgEnable**)
- Enabled status (the status that has been activated by **cfgEnable**)

If you enter the **cfgShow** command to display information about all zones, the TI zones appear in the defined zone configuration only and do not appear in the effective zone configuration.



1. Connect to the switch and log in using an account with admin permissions.
2. Enter the **zone --show** command.

```
zone --show [ name ] [-ascending]
```

To display information about the TI zone purplezone:

```
switch:admin> zone --show purplezone
Defined TI zone configuration:

TI Zone Name:   redzone:
Port List:      1,2; 1,3; 3,3; 4,5

Configured Status: Activated / Failover-Enabled
Enabled Status:  Activated / Failover-Enabled
```

To display information about all TI zones in the defined configuration in ascending order:

```
switch:admin> zone --show -ascending
Defined TI zone configuration:

TI Zone Name:   bluezone:
Port List:      8,3; 8,5; 9,2; 9,3;

Configured Status: Deactivated / Failover-Disabled
Enabled Status:  Activated / Failover-Enabled

TI Zone Name:   greenzone:
Port List:      2,2; 3,3; 4,11; 5,3;

Configured Status: Activated / Failover-Enabled
Enabled Status:  Activated / Failover-Enabled

TI Zone Name:   purplezone:
Port List:      1,2; 1,3; 3,3; 4,5;

Configured Status: Activated / Failover-Enabled
Enabled Status:  Deactivated / Failover-Enabled
```

## Troubleshooting TI zone routing problems

Use the following procedure to generate a report of existing and potential problems with TI zones. The report displays an error type.

- “ERROR” indicates a problem currently exists in the fabric.
- “WARNING” indicates that there is not currently a problem, given the current set of online devices and reachable domains, but given the activated TI zone configuration, parallel exclusive paths between a shared device and a remote domain have been detected, which might cause a problem for devices that join the fabric later.

1. Connect to the switch and log in using an account with admin permissions.
2. Enter the **zone --showTIerrors** command.

```
zone --showTIerrors
```

## 12 Setting up TI over FCR (sample procedure)

Following is an example report that would be generated for the illegal configuration shown in [Figure 36](#) on page 275.

```
switch:admin> zone --showTIerrors
My Domain: 3

Error type:          ERROR
Affected Remote Domain: 1
Affected Local Port: 8
Affected TI Zones:   etiz1, etiz2
Affected Remote Ports: 1, 2, 3, 4
```

## Setting up TI over FCR (sample procedure)

The following example shows how to set up TI zones over FCR to provide a dedicated path shown in [Figure 47](#). In this example, three TI zones are created: one in each of the edge fabrics and one in the backbone fabric. The combination of these three TI zones creates a dedicated path for traffic between Host 1 in edge fabric 1 and Targets 1 and 2 in edge fabric 2.

Host 1 has port WWN 10:00:00:00:00:08:00:00

Target 1 has port WWN 10:00:00:00:00:02:00:00

Target 2 has port WWN 10:00:00:00:00:03:00:00

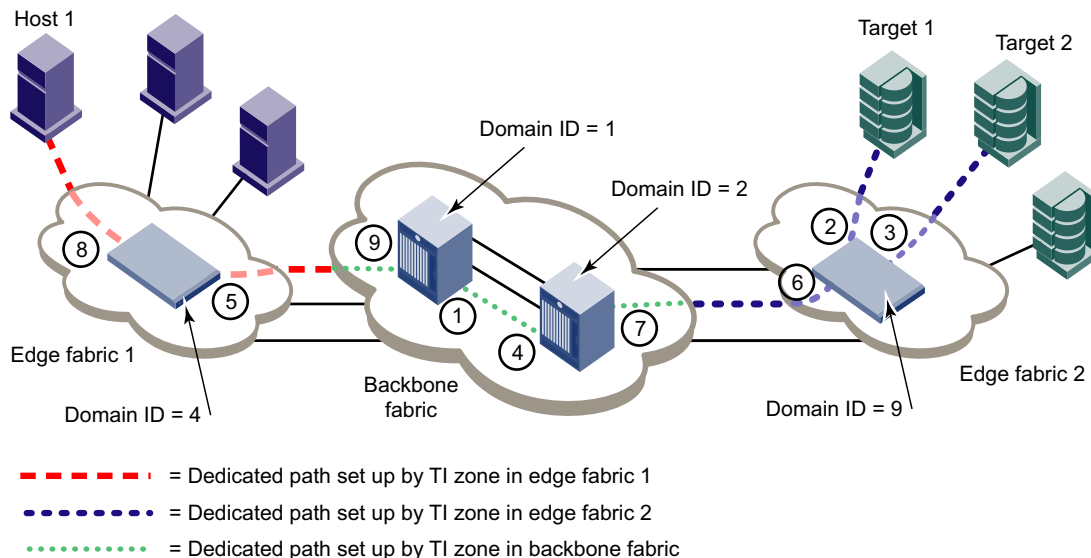

**FIGURE 47** TI over FCR example

### NOTE

In the following procedure the three TI zones in the edge and backbone fabrics are all given the same name, TI\_Zone1. It is not required that the TI zones have the same name, but this is done to avoid confusion. If several dedicated paths are set up across the FCR, the TI zones for each path can have the same name.

1. In each edge fabric, set up an LSAN zone that includes Host 1, Target 1, and Target 2, so these devices can communicate with each other. See [Chapter 24, "Using FC-FC Routing to Connect Fabrics,"](#) for information about creating LSAN zones.
2. Log in to the edge fabric 1 and set up the TI zone.
  - a. Enter the **fabricShow** command to display the switches in the fabric. From the output, you can determine the front and translate domains.

```

Elswitch:admin> fabricshow
Switch ID      Worldwide Name          Enet IP Addr    FC IP Addr      Name
-----
1: fffc01 50:00:51:e3:95:36:7e:04 0.0.0.0         0.0.0.0         "fcr_fd_1"
4: fffc04 10:00:00:60:69:80:1d:bc 10.32.72.4      0.0.0.0         >"Elswitch"
6: fffc06 50:00:51:e3:95:48:9f:a0 0.0.0.0         0.0.0.0         "fcr_xd_6_9"

```

The Fabric has 3 switches

- b. Enter the following commands to create and display a TI zone:

```

Elswitch:admin> zone --create -t ti TI_Zone1 -p "4,8; 4,5, 1,-1; 6,-1"
Elswitch:admin> zone --show
Defined TI zone configuration:

TI Zone Name:   TI_Zone1
Port List:      4,8; 4,5; 1,-1; 6,-1

Status: Activated      Failover: Enabled

```

- c. Enter the following commands to reactivate your current effective configuration and enforce the TI zones.

```

Elswitch:admin> cfgactvshow

Effective configuration:
cfg:   cfg_TI
zone:  lsan_t_i_TI_Zone1
      10:00:00:00:00:00:02:00:00
      10:00:00:00:00:00:03:00:00
      10:00:00:00:00:00:08:00:00

Elswitch:admin> cfgenable cfg_TI
You are about to enable a new zoning configuration.
This action will replace the old zoning configuration with the
current configuration selected.
If the update includes changes to one or more traffic isolation zones, the
update may result in localized disruption to traffic on ports associated
with the traffic isolation zone changes
Do you want to enable 'cfg_TI' configuration (yes, y, no, n): [no] y
zone config "cfg_TI" is in effect
Updating flash ...

```

## 12 Setting up TI over FCR (sample procedure)

### 3. Log in to the edge fabric 2 and set up the TI zone.

- Enter the **fabricShow** command to display the switches in the fabric. From the output, you can determine the front and translate domains.

```
E2switch:admin> fabricshow
Switch ID    Worldwide Name          Enet IP Addr    FC IP Addr      Name
-----
1: fffc01 50:00:51:e3:95:36:7e:09 0.0.0.0         0.0.0.0         "fcr_fd_1"
4: fffc04 50:00:51:e3:95:48:9f:a1 0.0.0.0         0.0.0.0         "fcr_xd_6_9"
9: fffc09 10:00:00:05:1e:40:f0:7d 10.32.72.9      0.0.0.0         >"E2switch"
```

The Fabric has 3 switches

- Enter the following commands to create and display a TI zone:

```
E2switch:admin> zone --create -t ti TI_Zone1 -p "9,2; 9,3; 9,6; 1,-1; 4,-1"
E2switch:admin> zone --show
Defined TI zone configuration:
```

```
TI Zone Name:  TI_Zone1
Port List:     9,2; 9,3; 9,6; 1,-1; 4,-1
```

```
Status: Activated      Failover: Enabled
```

- Enter the following commands to reactivate your current effective configuration and enforce the TI zones.

```
E2switch:admin> cfgactvshow

Effective configuration:
cfg:  cfg_TI
zone:  lsan_t_i_TI_Zone1
      10:00:00:00:00:00:02:00:00
      10:00:00:00:00:00:03:00:00
      10:00:00:00:00:00:08:00:00
```

```
E2switch:admin> cfgenable cfg_TI
You are about to enable a new zoning configuration.
This action will replace the old zoning configuration with the
current configuration selected.
If the update includes changes to one or more traffic isolation zones, the
update may result in localized disruption to traffic on ports associated
with the traffic isolation zone changes
Do you want to enable 'cfg_TI' configuration (yes, y, no, n): [no] y
zone config "cfg_TI" is in effect
Updating flash ...
```

### 4. Log in to the backbone fabric and set up the TI zone.

- Enter the following commands to create and display a TI zone:

```
BB_DCX_1:admin> zone --create -t ti TI_Zone1 -p "1,9; 1,1; 2,4; 2,7;
10:00:00:00:00:08:00:00; 10:00:00:00:00:02:00:00; 10:00:00:00:00:03:00:00"
BB_DCX_1:admin> zone --show
Defined TI zone configuration:
```

```
TI Zone Name:  TI_Zone1
Port List:     1,9; 1,1; 2,4; 2,7; 10:00:00:00:00:08:00:00;
10:00:00:00:00:02:00:00; 10:00:00:00:00:03:00:00
```

```
Status: Activated      Failover: Enabled
```

- b. Enter the following commands to reactivate your current effective configuration and enforce the TI zones.

```
BB_DCX_1:admin> cfgactvshow
```

```
Effective configuration:
```

```
cfg:  cfg_TI
zone:  lsan_t_i_TI_Zone1
      10:00:00:00:00:00:02:00:00
      10:00:00:00:00:00:03:00:00
      10:00:00:00:00:00:08:00:00
```

```
BB_DCX_1:admin> cfgenable cfg_TI
```

```
You are about to enable a new zoning configuration.
```

```
This action will replace the old zoning configuration with the
current configuration selected.
```

```
If the update includes changes to one or more traffic isolation zones, the
update may result in localized disruption to traffic on ports associated
with the traffic isolation zone changes
```

```
Do you want to enable 'cfg_TI' configuration (yes, y, no, n): [no] y
```

```
zone config "cfg_TI" is in effect
```

```
Updating flash ...
```

## 12 Setting up TI over FCR (sample procedure)

# Bottleneck Detection

---

## In this chapter

- [Bottleneck detection overview](#) . . . . . 297
- [Supported configurations for bottleneck detection](#) . . . . . 300
- [Advanced bottleneck detection settings](#) . . . . . 301
- [Enabling bottleneck detection on a switch](#) . . . . . 302
- [Excluding a port from bottleneck detection](#) . . . . . 303
- [Displaying bottleneck detection configuration details](#) . . . . . 304
- [Changing bottleneck parameters](#) . . . . . 305
- [Displaying bottleneck statistics](#) . . . . . 307
- [Disabling bottleneck detection on a switch](#) . . . . . 308

## Bottleneck detection overview

A *bottleneck* is a port in the fabric where frames cannot get through as fast as they should. In other words, a bottleneck is a port where the offered load is greater than the achieved egress throughput. Bottlenecks can cause undesirable degradation in throughput on various links. When a bottleneck occurs at one place, other points in the fabric can experience bottlenecks as the traffic backs up.

The bottleneck detection feature enables you to do the following:

- Prevent degradation of throughput in the fabric.

The bottleneck detection feature alerts you to the existence and locations of devices that are causing latency. If you receive alerts for one or more F\_Ports, use the CLI to check whether these F\_Ports have a history of bottlenecks.

- Reduce the time it takes to troubleshoot network problems.

If you notice one or more applications slowing down, you can determine whether any latency devices are attached to the fabric and where. You can use the CLI to display a history of bottleneck conditions on a port. If the CLI shows above-threshold bottleneck severity, you can narrow the problem down to device latency rather than problems in the fabric.

You can use the bottleneck detection feature with other Adaptive Networking features to optimize the performance of your fabric. For example, you can do the following:

- If the bottleneck detection feature detects a latency bottleneck, you can use TI zones or QoS SID/DID traffic prioritization to isolate latency device traffic from high priority application traffic.
- If the bottleneck detection feature detects ISL congestion, you can use ingress rate limiting to slow down low priority application traffic, if it is contributing to the congestion.

You configure bottleneck detection on a per-switch basis, with optional per-port exclusions.

---

**NOTE**

Bottleneck detection is disabled by default. Best practice is to enable bottleneck detection on all switches in the fabric, and leave it on to continuously gather statistics.

---

Bottleneck detection does not require a license.

## Types of bottlenecks

The bottleneck detection feature detects two types of bottlenecks:

- Latency bottleneck
- Congestion bottleneck

A *latency bottleneck* is a port where the offered load exceeds the rate at which the other end of the link can continuously accept traffic, but does not exceed the physical capacity of the link. This condition can be caused by a device attached to the fabric that is slow to process received frames and send back credit returns. A latency bottleneck due to such a device can spread through the fabric and can slow down unrelated flows that share links with the slow flow.

By default, bottleneck detection detects latency bottlenecks that are severe enough that they cause 98% loss of throughput. This default value can be modified to a different percentage.

A *congestion bottleneck* is a port that is unable to transmit frames at the offered rate because the offered rate is greater than the physical data rate of the line. For example, this condition can be caused by trying to transfer data at 8 Gbps over a 4 Gbps ISL.

You can use the **bottleneckMon** command to configure alert thresholds for congestion and latency bottlenecks.

Advanced settings allow you to refine the criterion for defining latency bottleneck conditions to allow for more (or less) sensitive monitoring at the sub-second level. For example, you would use the advanced settings to change the default value of 98% for loss of throughput.

If a bottleneck is reported, you can investigate and optimize the resource allocation for the fabric. Using the zone setup and Top Talkers, you can also determine which flows are destined to any affected F\_Ports.

## How bottlenecks are reported

Bottleneck detection uses the concept of an *affected second* when determining whether a bottleneck exists on a port. Each second is marked as being affected or unaffected by a latency or congestion bottleneck, based on certain criteria.

The bottleneck detection feature maintains a history of affected seconds for each port—one history for latency and another for congestion bottlenecks. A history is maintained for a maximum of three hours for each port. You can view the history using the **bottleneckmon --show** command, as described in [“Displaying bottleneck statistics”](#) on page 307.

Bottlenecks are also reported through RASlog alerts and SNMP traps. These two alerting mechanisms are intertwined and cannot be independently turned on and off. You can use the **bottleneckMon** command to specify alerting parameters for the following:

- Whether alerts are to be sent when a bottleneck condition is detected
- The size of the time window to look at when determining whether to alert



- How many affected seconds are needed to generate the alert.
- How long to stay quiet after an alert

Changing alerting parameters affects RASlog alerting as well as SNMP traps.

## Using alerting parameters to determine whether alerts are generated

You have the option of receiving per-port alerts based on the latency and congestion history of the port. Alerts are generated based on the number of affected seconds over a specified period of time. If the number of affected seconds is higher than the threshold, an alert is generated. This process is done independently for latency and congestion.

The **bottleneckmon** alerting parameters determine whether an alert is generated.

For example, [Figure 48](#) shows an interval of 12 seconds, in which 6 seconds are affected by a congestion bottleneck and 3 seconds are affected by a latency bottleneck.

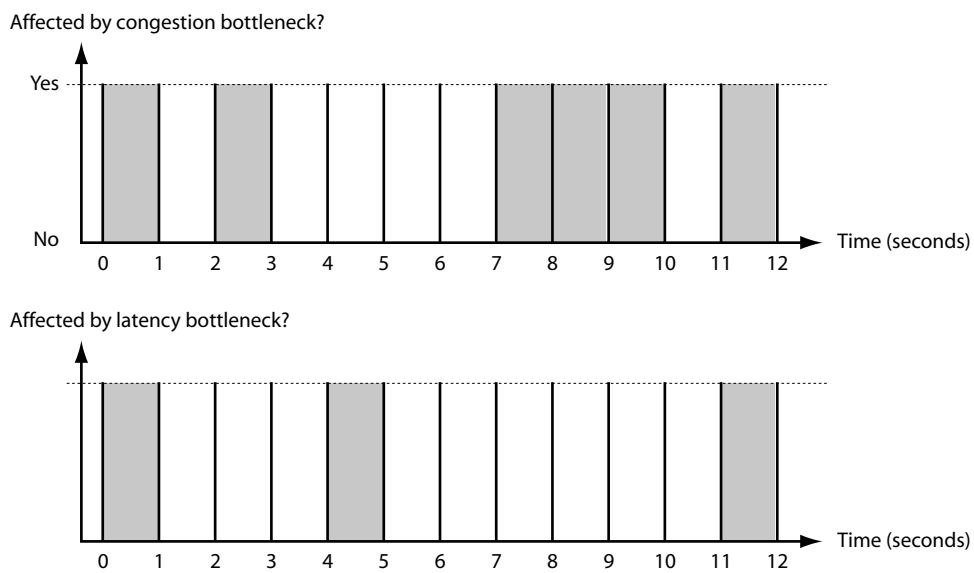

**FIGURE 48** Affected seconds for bottleneck detection

The **-time** parameter specifies the time window. For this example, **-time = 12** seconds.

The **-cthresh** and **-lthresh** parameters specify the thresholds on number of affected seconds that trigger alerts for congestion and latency bottlenecks, respectively. For this example, assume the default values for these parameters:

- **-cthresh = 0.8 (80%)**
- **-lthresh = 0.1 (10%)**

For this time window, 50% of the seconds (6 out of 12 seconds) are affected by congestion. This is below the threshold of 80%, so an alert would not be generated for a congestion bottleneck.

For the same time window, 25% of the seconds (3 out of 12 seconds) are affected by latency. This exceeds the threshold of 10%, so an alert would be generated for a latency bottleneck.

# Supported configurations for bottleneck detection

Note the following configuration rules for bottleneck detection:

- Bottleneck detection is supported only on Fibre Channel ports and FCoE F\_Ports.
- Bottleneck detection is supported only on the following port types:
  - E\_Ports
  - EX\_Ports
  - F\_Ports
  - FL\_Ports
- F\_Port and E\_Port trunks are supported.
- Long distance E\_Ports are supported.
- FCoE F\_Ports are supported.
- Bottleneck detection is supported on 4-Gbps, 8-Gbps, and 16-Gbps platforms, including 10-Gbps speeds.
- Bottleneck detection is supported in Access Gateway mode.
- Bottleneck detection is supported whether Virtual Fabrics is enabled or disabled. In VF mode, bottleneck detection is supported on all fabrics, including the base fabric. See [“Virtual Fabrics considerations for bottleneck detection”](#) on page 301 for additional information on using bottleneck detection in VF mode.

## Limitations of bottleneck detection

Using this feature for latency bottleneck detection is not recommended for link utilizations above 85%.

The bottleneck detection feature detects latency bottlenecks only at the point of egress, not ingress. For example, for E\_Ports, only the traffic egressing the port is monitored. For FCoE ports, bottleneck detection monitors traffic going from the FC side to the CEE side, and does not monitor traffic going in the reverse direction.

## High availability considerations for bottleneck detection

The bottleneck detection configuration is maintained across a failover or reboot; however, bottleneck statistics collected are lost.

## Upgrade and downgrade considerations for bottleneck detection

The bottleneck detection configuration is persistent across firmware upgrades and downgrades.

The sub-second latency criterion parameter settings are not preserved on downgrade to firmware versions earlier than Fabric OS 7.0.0. If you downgrade and then upgrade back to Fabric OS 7.0.0, the settings revert to their default values.

## Trunking considerations for bottleneck detection

A trunk behaves like a single port. Both latency and congestion bottlenecks are reported on the master port only, but apply to the entire trunk.

For masterless trunking, if the master port goes offline, the new master acquires all the configurations and bottleneck history of the old master and continues with bottleneck detection on the trunk.

## Virtual Fabrics considerations for bottleneck detection

Bottleneck detection is supported in both VF and non-VF modes.

In VF mode, if a port on which bottleneck detection is enabled is moved out of a logical switch, any per-port configurations are retained by the logical switch. The per-port configuration does not propagate outside of the logical switch. If the port is returned to the logical switch, the previous per-port configurations are automatically set for the port. See [“Changing bottleneck parameters”](#) on page 305 for more information about changing per-port configurations.

In logical fabrics, bottleneck detection is not performed on logical ISLs.

Because a base fabric carries traffic from multiple logical fabrics, bottlenecks reported in the base fabric can be caused by a mixture of traffic from multiple logical fabrics or by traffic from a single logical fabric. It is not possible to attribute a base fabric bottleneck to the exact logical fabric causing it. Dedicated ISLs are exclusive to one logical fabric, and any bottleneck on a dedicated ISL E\_Port pertains entirely to the traffic of that logical fabric.

## Access Gateway considerations for bottleneck detection

If bottleneck detection is enabled on a logical switch with some F\_Ports connected to an Access Gateway, you do not get information about which device is causing a bottleneck, because devices are not directly connected to this port. To detect bottlenecks on an Access Gateway, enable bottleneck detection on the Access Gateway to which the devices are actually connected.

# Advanced bottleneck detection settings

Bottleneck detection uses the concept of an *affected second* when determining whether a bottleneck exists on a port. Each second is marked as being affected or unaffected by a latency or congestion bottleneck, based on certain criteria.

You can use the sub-second latency criterion parameters to refine the criterion for determining whether a second is marked as affected by latency bottlenecks. For example, you might want to use the sub-second latency criterion parameters in the following cases:

- You notice an under-performing application, but do not see any latency bottlenecks detected. You can temporarily increase the sub-second sensitivity of latency bottleneck detection on the specific F\_Ports for this application.
- You want greater-than-default (sub-second) latency sensitivity on your fabric, so you set sub-second latency criterion parameters at the time you enable bottleneck detection.
- You want to reduce the number of alerts you are receiving about known latency bottlenecks in the fabric, so you temporarily decrease the sub-second latency sensitivity on these ports.
- You have a latency bottleneck on an ISL that is not at the edge of the fabric.

The sub-second latency criterion parameters are always applicable. These parameters affect alerts and, even if alerting is not enabled, they affect the history of bottleneck statistics.

The sub-second latency criterion parameters are the following, with default values in parentheses:

- **-lsubsectimethresh** (0.8) is similar to the **-lthresh** alerting parameter, except on a sub-second level. The default value of 0.8 means that at least 80% of a second must be affected by latency for the second to be marked as affected.
- **-lsubsecsevthresh** (50) specifies the factor by which throughput must drop in a second for that second to be considered affected by latency. The default value of 50 means that the observed throughput in a second must be no more than 1/50th the capacity of the port for that second to be counted as an affected second. 1/50th of capacity means 2% of capacity, which means 98% loss of throughput.

Sub-second latency criterion parameters apply only to latency bottlenecks and not congestion bottlenecks.

When you enable bottleneck detection, you can specify switch-wide sub-second latency criterion parameters. After you enable bottleneck detection, you can change the sub-second latency criterion parameters only on a per-port basis. You cannot change them on the entire switch, as you can with alerting parameters, unless you disable and then re-enable bottleneck detection.

Changing the sub-second latency criterion parameters on specific ports causes an interruption in the detection of bottlenecks on those ports, which means the history of bottlenecks is lost on these ports. Also note the following behaviors if you change the sub-second latency criterion parameters:

- Traffic through these ports is not affected.
- History of latency bottlenecks and congestion bottlenecks is lost on these ports. Other ports are not affected, however.
- The interruption occurs whether you set or clear per-port overrides on the sub-second latency criterion parameters.
- Because of the interruption, you can never have an alert for a port such that the alert spans periods of time with different sub-second latency criteria on that port.

## Enabling bottleneck detection on a switch

Enabling bottleneck detection enables both latency and congestion detection.

Bottleneck detection is enabled on a switch basis. It is recommended that you enable bottleneck detection on every switch in the fabric. If you later add additional switches, including logical switches, to the fabric, be sure to enable bottleneck detection on those switches as well.

When you enable bottleneck detection on a switch, the settings are applied to all eligible ports on that switch. If ineligible ports later become eligible or, in the case of a logical switch, if ports are moved to the logical switch, bottleneck detection is automatically applied to those ports.

You can later override these settings on a port basis, as described in [“Changing bottleneck parameters”](#) on page 305.

1. Connect to the switch and log in using an account with admin permissions.
2. Enter the **bottleneckmon --enable** command to enable bottleneck detection on all eligible ports on the switch.

By default, alerts are not sent unless you specify the **alert** parameter; however, you can view a history of bottleneck conditions for the port as described in [“Displaying bottleneck statistics”](#) on page 307.

3. Repeat [step 1](#) and [step 2](#) on every switch in the fabric.

---

**NOTE**

Best practice is to use the default values for the alerting and sub-second latency criterion parameters.

---

**Example of enabling bottleneck detection**

(Preferred use case) The following example enables bottleneck detection on the switch with alerts using default values for thresholds and time.

```
switch:admin> bottleneckmon --enable -alert
```

The following example enables bottleneck detection on the switch without alerts. Although alerts are not delivered in bottleneck conditions, you can view the bottleneck history using the CLI.

```
switch:admin> bottleneckmon --enable
```

## Excluding a port from bottleneck detection

When you exclude a port from bottleneck detection, no data is collected from the port and no alerts are generated for the port. All statistics history for the port is discarded.

Alerting parameters for the port are preserved, so if you later include the port for bottleneck detection, the alerting parameters are restored.

Per-port exclusions might be needed if, for example, a long-distance port is known to be a bottleneck because of credit insufficiency. In general, however, per-port exclusions are not recommended.

For trunking, if you exclude a slave port from bottleneck detection, the exclusion has no effect as long as the port is a trunk slave. The exclusion takes effect only if the port becomes a trunk master or leaves the trunk.

1. Connect to the switch to which the target port belongs and log in using an account with admin permissions.
2. Enter the **bottleneckmon --exclude** command to exclude the port from bottleneck detection.

To later include the port, enter the **bottleneckmon --include** command.

**Example**

```
switch:admin> bottleneckmon --exclude 4
```

## Displaying bottleneck detection configuration details

1. Connect to the switch and log in using an account with admin permissions.
2. Enter the **bottleneckmon --status** command to display the details of bottleneck detection configuration for the switch, which includes the following:
  - Whether the feature is enabled
  - Switch-wide parameters
  - Per-port overrides, if any
  - Excluded ports

### Example

```
switch:admin> bottleneckmon --status
Bottleneck detection - Enabled
=====

Switch-wide sub-second latency bottleneck criterion:
=====
Time threshold           - 0.800
Severity threshold       - 50.000

Switch-wide alerting parameters:
=====
Alerts                   - Yes
Latency threshold for alert - 0.100
Congestion threshold for alert - 0.800
Averaging time for alert  - 300 seconds
Quiet time for alert      - 300 seconds

Per-port overrides for sub-second latency bottleneck criterion:
=====
Slot   Port   TimeThresh   SevThresh
=====
0      3      0.500        100.000
0      4      0.600        50.000
0      5      0.700        20.000

Per-port overrides for alert parameters:
=====
Slot   Port   Alerts? LatencyThresh   CongestionThresh   Time (s)
QTime (s)
=====
0      1      Y       0.990           0.900              3000              600
0      2      Y       0.990           0.900              4000              600
0      3      Y       0.990           0.900              4000              600

Excluded ports:
=====
Slot   Port
=====
0      2
0      3
0      4
```

## Changing bottleneck parameters

When you enable bottleneck detection, you can configure switch-wide alerting and sub-second latency criterion parameters that apply to every port on the switch. After you enable bottleneck detection, you can change the alerting parameters on the entire switch or on individual ports. You can change the sub-second latency criterion parameters on individual ports only. You can also change the parameters on ports that have been excluded from bottleneck detection.

The alerting parameters indicate whether alerts are sent, and the threshold, time, and quiet time options.

For a trunk, you can change the parameters only on the master port.

1. Connect to the switch and log in using an account with admin permissions.
2. Enter the **bottleneckmon --config** command to set the alerting and sub-second latency criterion parameters.

Enter the **bottleneckmon --configclear** command to remove any port-specific alerting and sub-second latency criterion parameters and revert to the switch-wide parameters.

### Example

The following example disables alerts on port 1, excludes ports 2, 3, and 4 from bottleneck monitoring, and changes the alerting parameters on ports 2 and 3. The **bottleneck --status** command shows the settings for these ports. Note that this example changes the alerting parameters on ports 2 and 3, even though they are excluded from bottleneck detection.

```
switch:admin> bottleneckmon --config -noalert 1
switch:admin> bottleneckmon --exclude 2-4
switch:admin> bottleneckmon --config -alert -lthresh .99 -cthresh .9 -time
4000 -qtime 600 2-3
switch:admin> bottleneckmon --status
Bottleneck detection - Enabled
=====

Switch-wide sub-second latency bottleneck criterion:
=====
Time threshold           - 0.800
Severity threshold       - 50.000

Switch-wide alerting parameters:
=====
Alerts                   - Yes
Latency threshold for alert - 0.100
Congestion threshold for alert - 0.800
Averaging time for alert  - 300 seconds
Quiet time for alert      - 300 seconds

Per-port overrides for alert parameters:
=====
Port  Alerts?  LatencyThresh  CongestionThresh  Time (s)  QTime (s)
=====
1     N        --             --                --        --
2     Y        0.990         0.900             4000     600
3     Y        0.990         0.900             4000     600

Excluded ports:
=====
Port
```

## 13 Changing bottleneck parameters

```
====  
2  
3  
4
```

### Example

The following example changes alerting parameters for the entire logical switch.

```
switch:admin> bottleneckmon --config -alert -lthresh .97 -cthresh .8 -time  
5000  
switch:admin> bottleneckmon --status  
Bottleneck detection - Enabled  
=====
```

Switch-wide sub-second latency bottleneck criterion:  
=====

```
Time threshold          - 0.800  
Severity threshold      - 0.100
```

Switch-wide alerting parameters:  
=====

```
Alerts                  - Yes  
Latency threshold for alert - 0.970  
Congestion threshold for alert - 0.800  
Averaging time for alert   - 5000 seconds  
Quiet time for alert      - 300 seconds
```

Per-port overrides for alert parameters:  
=====

Port	Alerts?	LatencyThresh	CongestionThresh	Time (s)	QTime (s)
1	N	--	--	--	--
2	Y	0.990	0.900	4000	600
3	Y	0.990	0.900	4000	600

Excluded ports:  
=====

```
Port  
====  
2  
3  
4
```

### Example

The following example changes the sub-second latency criterion parameters for port 6.

```
switch:admin> bottleneckmon --config -lsubsectimethresh .6 -lsubsecsevthresh  
40 6  
switch:admin> bottleneckmon --status  
Bottleneck detection - Enabled  
=====
```

Switch-wide sub-second latency bottleneck criterion:  
=====

```
Time threshold          - 0.800  
Severity threshold      - 50.000
```

Switch-wide alerting parameters:  
=====



```

Alerts                               - Yes
Latency threshold for alert          - 0.100
Congestion threshold for alert       - 0.800
Averaging time for alert             - 300 seconds
Quiet time for alert                 - 300 seconds

Per-port overrides for sub-second latency bottleneck criterion:
=====
Port      TimeThresh      SevThresh
=====
6         0.600           40.000

Per-port overrides for alert parameters:
=====
Port  Alerts? LatencyThresh  CongestionThresh  Time(s)  QTime(s)
=====
6     N      --             --              --       --
    
```

## Displaying bottleneck statistics

You can use the **bottleneckmon --show** command to display a history of bottleneck conditions, for up to three hours. This command has several display options:

- Display only latency bottlenecks, only congestion bottlenecks, or both combined.
  - Display bottleneck statistics for a single port, bottleneck statistics for all ports on the switch, or a list of ports affected by bottleneck conditions.
  - Continuously update the displayed data with fresh data.
1. Connect to the switch and log in using an account with admin permissions.
  2. Enter the **bottleneckmon --show** command.

### Example of displaying the bottleneck history in 5-second windows over a period of 30 seconds

In this example, the definition of *bottlenecked ports* is any port that had a bottleneck occur during any second in the corresponding interval.

```

switch:admin> bottleneckmon --show -interval 5 -span 30

=====
                        Wed Jan 13 18:54:35 UTC 2010
=====
List of bottlenecked ports in most recent interval:
23
=====
From                               To                               Number of
                                bottlenecked ports
=====
Jan 13 18:54:05                    Jan 13 18:54:10                    1
Jan 13 18:54:10                    Jan 13 18:54:15                    2
Jan 13 18:54:15                    Jan 13 18:54:20                    1
Jan 13 18:54:20                    Jan 13 18:54:25                    1
Jan 13 18:54:25                    Jan 13 18:54:30                    0
Jan 13 18:54:30                    Jan 13 18:54:35                    0
    
```

### Disabling bottleneck detection on a switch

When you disable bottleneck detection on a switch, all bottleneck configuration details are discarded, including the list of excluded ports and non-default values of alerting parameters.

1. Connect to the switch and log in using an account with admin permissions.
2. Enter the **bottleneckmon --disable** command to disable bottleneck detection on the switch.

```
switch:admin> bottleneckmon --disable
```

# In-flight Encryption and Compression

---

## In this chapter

- [In-flight encryption and compression overview](#) . . . . . 309
- [Configuring encryption and compression](#) . . . . . 312
- [Encryption and compression example](#) . . . . . 317

## In-flight encryption and compression overview

The in-flight encryption and compression features of Fabric OS allow frames to be encrypted or compressed at the egress point of an ISL between two Brocade switches, and then to be decrypted or decompressed at the ingress point of the ISL. These features use port-based encryption and compression.

---

**NOTE**

The in-flight encryption and compression features are supported only on 16 Gbps-capable E\_Ports on the Brocade 6510 switch and the Brocade DCX 8510 Backbone family.

---

The purpose of encryption is to provide security for frames while they are in flight between two switches. The purpose of compression is for better bandwidth use on the ISLs, especially over long distance. An average compression ratio of 2:1 is provided. Frames are never left in an encrypted or compressed state when delivered to an end device. Both ends of the ISL must terminate on 16 Gbps-capable ports.

Encryption and compression can be enabled at the same time for an ISL, or you can enable either encryption or compression selectively. [Figure 49](#) shows an example of 16 Gbps links connecting three Brocade switches. One link is configured with encryption and compression, one with just encryption, and one with just compression.

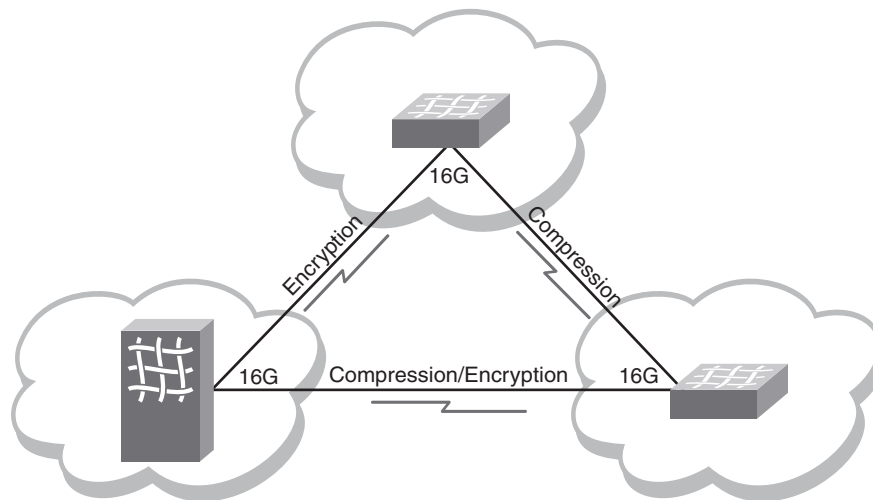

**FIGURE 49** Encryption and compression on 16 Gbps ISLs

The encryption and compression features are designed to work only with E\_Ports. Encryption and compression are also compatible with the following features:

- E\_Ports with trunking, QoS, or long distance features enabled.
- Flow control modes R\_RDY, VC\_RDY, and EXT\_VC\_RDY.
- XISL ports in VF mode.
- FCP data frames and non-FCP data frames except ELS and BLS frames.

FCP data frames are of Type=0x8. For encryption, R\_CTL=0x1 and R\_CTL=0x4 are supported. For compression, only R\_CTL=0x1 is supported.

Non FCP data frames are of Type != 0x8. Non FCP frames with ELS/BLS (R\_CTL==0x2 || R\_CTL== 0x8) are not supported.

No license is needed to configure and enable in-flight encryption or compression.

## Encryption and compression restrictions

- No more than two ports on one ASIC can be configured with encryption, compression, or both. This restriction equates to a maximum of four ports per FC16-32 or FC16-48 blade, or two ports per Brocade 6510 switch.
- The number of ports in a trunk is limited to two ports when encryption or compression is enabled for the trunk.
- Ports must be 16 Gbps capable, although port speed can be any configurable value.
- The devices at either end of the ISL must run Fabric OS 7.0.0 or later software.
- Only E\_Ports are supported. Although VE\_Ports, VEX\_Ports, EX\_Ports, GE ports, FCoE ports, F\_Ports, F\_Port trunks, ICL ports, and D\_Ports cannot be configured for encryption or compression, they can exist along the I/O path.
- The encryption feature is not supported in FIPS mode. In-flight encryption is not FIPS compliant.
- Brocade Network Advisor does not support encryption or compression.
- LIL through any encryption-enabled port or compression-enabled port is not supported.

## How encryption and compression are enabled

This feature provides encryption and decryption or compression and decompression between two E\_Ports across an ISL. You can enable encryption or compression or both on an E\_Port on a per port basis. By default, this feature is disabled on all ports on a switch.

Encryption and compression capabilities and configurations from each end of the ISL are exchanged during E\_Port initialization. Capabilities and configurations must match, otherwise port segmentation or disablement occurs. If the port was configured for compression, then the compression feature is enabled.

If the port was configured for encryption, authentication is performed and the keys needed for encryption are generated. The encryption feature is enabled if authentication is successful. If authentication fails, then the ports are segmented.

## Authentication and key generation

The Diffie Hellman - Challenge Handshake Authentication Protocol (DH-CHAP) protocol must be configured along with the DH group 4 for port level authentication as a prerequisite for in-flight encryption. Pre-shared secret keys must be configured on the devices at either end of the ISL to perform authentication. Authentication secrets greater than 32 characters are recommended for stronger encryption keys.. Once the link is authenticated, the keys are generated and exchanged.

---

### NOTE

In-flight encryption uses DH-CHAP authentication (SHA-1 algorithm) followed by Internet Key Exchange (IKE) protocol (HMAC-SHA-512 algorithm) to generate the keys.

---

These encryption keys never expire. While the port remains online, the keys generated for the port remain the same. When a port is disabled, segmented, or taken offline, a new set of keys is generated when the port is enabled again.

All members of a trunk group use the same set of keys as the master port. Slave ports do not exchange keys. If the master port goes offline causing an E\_Port change, the trunk continues to use the same set of keys.

## Availability considerations

For FC16-32 or FC16-48 blades, if the two ports configured for encryption or compression within the same ASIC are not configured for trunking, it is recommended to connect each ISL to a different ASIC on the peer switch. Similarly, configure the two ports on the other ASIC of the blade. If the ports are configured for trunking, it is recommended to connect each trunk group to different ASICs of the peer switch. Configuring all 4 ports of the blade with this suggested configuration will provide redundancy in the event of encryption/compression port failures.

For the Brocade 6510, if its two ports are not configured for trunking, it is recommended to connect each ISL to different ASICs of the peer switch.

---

### NOTE

If any port on the ASIC with encryption or compression enabled encounters rare error conditions that would need error recovery to be performed on the encryption engine within that ASIC, it causes all encryption or compression enabled ports (maximum of two ports) on that ASIC to go offline.

---

## Virtual Fabrics considerations

The E\_Ports in the user-created logical switch, base switch, or default switch can support encryption and compression. You can configure encryption on XISL ports, but not on LISL ports. However, frames from the LISL ports are implicitly encrypted or compressed as they pass through encryption/compression enabled XISL ports.

If an encryption or compression enabled port needs to be moved from one logical switch to another logical switch, the movement of the port is blocked. You must disable the encryption and compression configurations before moving the port, and then enable encryption and compression after the port has moved.

## Recommendation for compression

When configuring compression on long distance ports, it is recommended to configure the long distance ports with double the number of buffers. This can be done by configuring the port with long distance LS mode and specifying the number of buffers to allocate to the port.

## Configuring encryption and compression

On a given ISL between two 16 Gbps E\_Ports, you can configure each port for encryption, compression, or both. Your encryption and compression settings must match at either end of the ISL. Port segmentation will occur during port initialization if these configurations do not match.

Before configuring a port for encryption, you must configure the port for authentication using the **authUtil** and **secAuthSecret** commands:

- Use the **authUtil** command to enable switch authentication, enable the DH-CHAP authentication protocol for ports that support encryption, and select the appropriate DH (Diffie-Hellman) group (4 or “\*”).  
  
To enable switch authentication, use the **authUtil --policy** command with the **-sw** option to select either the on mode or the active mode.  
  
To enable the DH-CHAP authentication protocol, use the **authUtil --set** command with the **-a** option and select either **dhchap** or **all**. **dhchap** explicitly specifies the DH-CHAP protocol. Although **all** enables both FCAP and DH-CHAP, the active protocol defaults to DH-CHAP for all ports configured for in-flight encryption.  
  
To select the appropriate DH group, use the **authUtil --set** command with the **-g** option and choose either group 4 or “\*”. If “\*” is entered, then group 4 is selected from a list.
- Use the **secAuthSecret** command to configure a pre-shared secret on both sides of the ISL for all ports configured for in-flight encryption. A secret of at least 32 characters is recommended. Maximum is 40 characters.

Port segmentation will occur during port initialization if authentication fails.

If you need to disable authentication on a port that has encryption or compression configured, you must first disable encryption or compression on the port, and then disable authentication.

These steps summarize how to enable encryption or compression on a port:

1. Use the **portEncCompShow** command to determine which ports are available for encryption or compression.
2. If you are enabling encryption on the port, configure port level authentication for the port using the **secAuthSecret** and **authUtil** commands. Omit this step if you want to enable only compression on the port.
3. Use the **portCfgEncrypt** command to enable encryption on the port. This step fails if you try to exceed the number of allowable ports available for encryption or compression on the ASIC.
4. Use the **portCfgCompress** command to enable compression on the port. This step fails if you try to exceed the number of allowable ports available for encryption or compression on the ASIC.

Following successful port initialization, the configured features are enabled and active. You can use the **islShow** command to check that the E\_Port has come online with encryption or compression enabled.

If port initialization is not successful, you can check for port segmentation errors with the **switchShow** command. This command will tell you if the segmentation was due to mismatched encryption or compression configurations on the ports at either end of the ISL, if port-level authentication failed, or if a required resource was not available.

The following topics provide step-by-step instructions for performing encryption and compression tasks:

- [“Viewing the encryption and compression configuration”](#) on page 313
- [“Configuring and enabling authentication”](#) on page 314
- [“Configuring encryption”](#) on page 315
- [“Configuring compression”](#) on page 316

## Viewing the encryption and compression configuration

To determine which ports are available for encryption or compression on each ASIC on the switch, follow these steps:

1. Connect to the switch and log in using an account with admin permissions.
2. Enter the **portEncCompShow** command.

The following example shows the output for two ASICs. ASIC 1 (below the line of dashes) already has compression configured and active on user ports 348 and 349. Given the limit of two ports per ASIC, ASIC 1 has no more ports available for encryption or compression. ASIC 0 (above the dashed line) has no ports configured for either encryption or compression and therefore has any two ports available for this purpose. For bladed switches, use the **switchShow** command to determine the slot number of a specific user port.

```
sw0:FID128:root> portenccompshow
User          Encryption          Compression
Port  configured  Active  configured  Active
-----
  17         No         No         No         No
  18         No         No         No         No
  19         No         No         No         No
  20         No         No         No         No
  21         No         No         No         No
```

## 14 Configuring encryption and compression

22	No	No	No	No
23	No	No	No	No
144	No	No	No	No
145	No	No	No	No
146	No	No	No	No
147	No	No	No	No
148	No	No	No	No
149	No	No	No	No
150	No	No	No	No
151	No	No	No	No
-----				
88	No	No	No	No
89	No	No	No	No
90	No	No	No	No
91	No	No	No	No
92	No	No	No	No
93	No	No	No	No
94	No	No	No	No
95	No	No	No	No
208	No	No	No	No
209	No	No	No	No
210	No	No	No	No
211	No	No	No	No
212	No	No	No	No
213	No	No	No	No
214	No	No	No	No
215	No	No	No	No
344	No	No	No	No
345	No	No	No	No
346	No	No	No	No
347	No	No	No	No
348	No	No	Yes	Yes
349	No	No	Yes	Yes
350	No	No	No	No
351	No	No	No	No

### Configuring and enabling authentication

To configure authentication for ports that will later be configured for encryption, follow these steps:

1. Log in to the switch using an account with admin permissions, or an account with OM permissions for the Authentication RBAC class of commands.
2. Enter the **secAuthSecret --set** command to establish pre-shared secrets at each end of the ISL. It is recommended to use a 32 bit secret for an ISL carrying encrypted or compressed traffic.

```
secauthsecret --set
```

When prompted, enter the WWN for the local switch and secret strings for the local switch and the remote switch.

---

#### NOTE

When setting a secret key pair, you are entering the shared secrets in plain text. Use a secure channel, such as SSH or the serial console, to connect to the switch on which you are setting the secrets.

---



3. Enter the **authUtil** command to set the switch policy mode to Active or On:

```
authutil --policy -sw active
```

or:

```
authutil --policy -sw on
```

4. Enable the DH-CHAP authentication protocol:

```
authutil --set -a dhchap
```

or:

```
authutil --set -a all
```

5. Enable authentication with DH group 4 or "\*":

```
authutil --set -g 4
```

DH Group was set to 4.

or

```
authutil --set -g "*"
```

DH Group was set to 0,1,2,3,4.

For additional information about establishing DH-CHAP secrets, see [“Secret key pairs for DH-CHAP”](#) on page 149.

For additional information about configuring DH-CHAP authentication for E\_Ports, see [“Authentication policy for fabric elements”](#) on page 143.

## Configuring encryption

---

### NOTE

Before performing this procedure, you must authenticate the port as described in [“Configuring and enabling authentication”](#) on page 314. It is also recommended that you check for port availability using the **portEncCompShow** command. See [“Viewing the encryption and compression configuration”](#) on page 313 for details.

---

To configure encryption on a port, follow these steps:

1. Connect to the switch and log in using an account with secure admin permissions, or an account with OM permissions for the EncryptionConfiguration RBAC class of commands.
2. Disable the port on which you want to configure encryption. Use the **portDisable** command.
3. Enter the **portCfgEncrypt --enable** command.

This example enables encryption on port 21 on a Brocade 6510 switch:

```
portcfgencrypt --enable 21
```

This example enables encryption on port 15 of an FC16-32 blade in slot 9 of an enterprise class platform:

```
portcfgencrypt --enable 9/15
```

4. Enable the port with the **portEnable** command.

After manually enabling the port, the new configuration becomes active.

## Configuring compression

---

### NOTE

Before performing this procedure, it is recommended that you check for port availability using the **portEncCompShow** command. See [“Viewing the encryption and compression configuration”](#) on page 313 for details.

---

To configure compression on a port, follow these steps:

1. Connect to the switch and log in using an account with admin permissions, or an account with OM permissions for the SwitchPortConfiguration RBAC class of commands.
2. Disable the port on which you want to configure compression. Use the **portDisable** command.
3. Enter the **portCfgCompress --enable** command.

This example enables compression on port 21 on a Brocade 6510 switch:

```
portcfgcompress --enable 21
```

This example enables compression on port 15 of an FC16-32 blade in slot 9 of an enterprise class platform:

```
portcfgcompress --enable 9/15
```

4. Enable the port with the **portEnable** command.

After enabling the port, the new configuration becomes active.

## Disabling encryption

To disable encryption on a port, follow these steps:

1. Connect to the switch and log in using an account with secure admin permissions, or an account with OM permissions for the EncryptionConfiguration RBAC class of commands.
2. Disable the port on which you want to disable encryption. Use the **portDisable** command.
3. Enter the **portCfgEncrypt --disable** command.

This example disables encryption on port 21 on a Brocade 6510 switch:

```
portcfgencrypt --disable 21
```

This example disables encryption on port 15 of an FC16-32 blade in slot 9 of an enterprise class platform:

```
portcfgencrypt --disable 9/15
```

4. Enable the port with the **portEnable** command.

After enabling the port, the new configuration becomes active.

## Disabling compression

To disable compression on a port, follow these steps:

1. Connect to the switch and log in using an account with admin permissions, or an account with OM permissions for the SwitchPortConfiguration RBAC class of commands.
2. Disable the port on which you want to disable compression. Use the **portDisable** command. Enter the **portCfgCompress --disable** command.

This example disables compression on port 21 on a Brocade 6510 switch:

```
portcfgcompress --disable 21
```

This example disables compression on port 15 of an FC16-32 blade in slot 9 of an enterprise class platform:

```
portcfgcompress --disable 9/15
```

3. Enable the port with the **portEnable** command.

After enabling the port, the new configuration becomes active.

## Encryption and compression example

The following example shows configuring and enabling encryption and compression. In this case, encryption and compression are applied to the E\_Ports at either end of an ISL connecting a port on a blade in an enterprise class platform named myDCX to a port on a Brocade 6510 switch named myswitch. [Table 59](#) identifies each end of the ISL connection by device name, device WWN, and port number.

**TABLE 59** Example ISL connections

	Enterprise class platform	Brocade 6510
Name	myDCX	myswitch
WWN	10:00:00:05:1e:e5:cb:00	10:00:00:05:33:13:71:3e
port ID	port index: 246 slot number: 12 port number: 22	port number: 0

The example includes the following steps:

- Setting up authentication to permit key generation
- Enabling encryption
- Enabling compression
- Disabling encryption
- Disabling compression

## Example of enabling encryption and compression on a port

This example configures and enables encryption and compression on a given port. Authentication and secret key must also be configured as these are required before configuring encryption. The commands in this example are shown entered on the Brocade 6510 named myswitch. The same commands must also be entered on the peer switch.

This first part of the example shows a command sequence that sets up authentication in preparation for in-flight encryption. Specifically, it configures the DH-CHAP protocol for authentication, sets the DH group to group 4, and activates authentication:

```
myswitch:root> authutil --show
AUTH TYPE      HASH TYPE      GROUP TYPE
-----
fcap,dhchap    sha1,md5       0,1,2,3,4

Switch Authentication Policy: PASSIVE
Device Authentication Policy: OFF

myswitch:root> authutil --set -a dhchap
myswitch:root> authutil --set -g "*"
myswitch:root> authutil --policy -sw active
Warning: Activating the authentication policy requires either DH-CHAP secrets
or PKI certificates depending on the protocol selected. Otherwise, ISLs will
be segmented during next E-port bring-up.
ARE YOU SURE (yes, y, no, n): [no] y
Auth Policy is set to ON
myswitch:root> authutil --show
AUTH TYPE      HASH TYPE      GROUP TYPE
-----
dhchap         md5            4

Switch Authentication Policy: ON
Device Authentication Policy: OFF
myswitch:root>
```

Next, you set a secret key. For this you need to get the WWN of the peer switch.

```
myswitch:root> secauthsecret
Usage: secAuthSecret <args>

--show: displays the secret key database
--set: sets up (add or modify) secret keys
--remove [wwn | domain | <sw name>]: removes an entry from secret key database
--remove --all: deletes secret key database
myswitch:root> secauthsecret --set
```

This command is used to set up secret keys for the DH-CHAP authentication. The minimum length of a secret key is 8 characters and maximum 40 characters. Setting up secret keys does not initiate DH-CHAP authentication. If switch is configured to do DH-CHAP, it is performed whenever a port or a switch is enabled.

Warning: Please use a secure channel for setting secrets. Using an insecure channel is not safe and may compromise secrets.

Following inputs should be specified for each entry.

1. WWN for which secret is being set up.

2. Peer secret: The secret of the peer that authenticates to peer.
3. Local secret: The local secret that authenticates peer.

Press enter to start setting up secrets >1

Enter peer WWN, Domain, or switch name (Leave blank when done):

**10:00:00:05:1e:e5:cb:00**

Enter peer secret:

Re-enter peer secret:

Enter local secret:

Re-enter local secret:

Enter peer WWN, Domain, or switch name (Leave blank when done):

Are you done? (yes, y, no, n): [no] **y**

Saving data to key store... Done.

myswitch:root> **secauthsecret --show**

WWN	DID	Name
10:00:00:05:1e:e5:cb:00	150	dcx_150

myswitch:root>

Next, you enable encryption on port 0. Note that the first attempt fails because the port is currently enabled. This example uses the **portCfgShow** command to check the result. Notice that the output shows encryption to be enabled on the port.

```
myswitch:root> portcfgencrypt --enable 0
Please disable port to configure Encryption/Compression.
myswitch:root> portdisable 0
myswitch:root> portcfgencrypt --enable 0
Turning ON Encryption on port(246) will cause the port to be disabled during
next LOGIN
myswitch:root> portenable 0
myswitch:root> portcfgshow 0
Area Number: 0
Octet Speed Combo: 3 (16G,10G)
Speed Level: AUTO (SW)
AL_PA Offset 13: OFF
Trunk Port ON
Long Distance OFF
VC Link Init OFF
Locked L_Port OFF
Locked G_Port OFF
Disabled E_Port OFF
Locked E_Port OFF
ISL R_RDY Mode OFF
RSCN Suppressed OFF
Persistent Disable OFF
LOS TOV enable OFF
NPIV capability ON
QOS E_Port AE
Port Auto Disable: OFF

Rate Limit OFF
EX Port OFF
Mirror Port OFF
Credit Recovery ON
F_Port Buffers OFF
Fault Delay: 0 (R_A_TOV)
NPIV PP Limit: 126
CSCTL mode: OFF
```

## 14 Encryption and compression example

```
Frame Shooter Port      OFF
D-Port mode:           OFF
Compression:           OFF
Encryption:            ON
FEC:                   OFF
myswitch:root>
```

Finally, you enable compression on the same port. The subsequent **portCfgShow** command shows both encryption and compression to be enabled on the port.

```
myswitch:root> portdisable 0
myswitch:root> portcfgcompress --enable 0
Turning ON Compression on port(0) will cause the port to be disabled during
next LOGIN
myswitch:root> portenable 0
myswitch:root> portcfgshow 0
Area Number:          0
Octet Speed Combo:   3 (16G,10G)
Speed Level:         AUTO (SW)
AL_PA Offset 13:     OFF
Trunk Port           ON
Long Distance        OFF
VC Link Init         OFF
Locked L_Port        OFF
Locked G_Port        OFF
Disabled E_Port      OFF
Locked E_Port        OFF
ISL R_RDY Mode       OFF
RSCN Suppressed      OFF
Persistent Disable   OFF
LOS TOV enable       OFF
NPIV capability      ON
QOS E_Port           AE
Port Auto Disable:   OFF

Rate Limit           OFF
EX Port              OFF
Mirror Port          OFF
Credit Recovery      ON
F_Port Buffers       OFF
Fault Delay:         0 (R_A_TOV)
NPIV PP Limit:       126
CSCTL mode:          OFF
Frame Shooter Port   OFF
D-Port mode:         OFF
Compression:         ON
Encryption:          ON
FEC:                 OFF
myswitch:root>
```

### Example of disabling encryption and compression

This example disables the encryption and compression that were enabled in the previous example.

The first part of the example shows a command sequence that disables encryption on port 0:

```
myswitch:root> portdisable 0
myswitch:root> portcfgencrypt --disable 0
myswitch:root> portenable 0
```

Next, disable compression:

```
myswitch:root> portdisable 0
myswitch:root> portcfgcompress --disable 0
myswitch:root> portenable 0
```

Now use the **portCfgShow** command to check the results:

```
myswitch:root> portcfgshow 0
Area Number:                0
Octet Speed Combo:          3 (16G,10G)
Speed Level:                 AUTO (SW)
AL_PA Offset 13:            OFF
Trunk Port                   ON
Long Distance                OFF
VC Link Init                 OFF
Locked L_Port                OFF
Locked G_Port                OFF
Disabled E_Port              OFF
Locked E_Port                OFF
ISL R_RDY Mode               OFF
RSCN Suppressed              OFF
Persistent Disable            OFF
LOS TOV enable               OFF
NPIV capability              ON
QOS E_Port                   AE
Port Auto Disable:           OFF

Rate Limit                   OFF
EX Port                       OFF
Mirror Port                   OFF
Credit Recovery              ON
F_Port Buffers                OFF
Fault Delay:                  0 (R_A_TOV)
NPIV PP Limit:                126
CSCTL mode:                   OFF
Frame Shooter Port            OFF
D-Port mode:                  OFF
Compression:                  OFF
Encryption:                   OFF
FEC:                           OFF
myswitch:root>
```

## 14 Encryption and compression example



# NPIV

---

## In this chapter

- [NPIV overview](#) ..... 323
- [Configuring NPIV](#) ..... 325
- [Enabling and disabling NPIV](#) ..... 326
- [Viewing NPIV port configuration information](#) ..... 327

## NPIV overview

N\_Port ID Virtualization (NPIV) enables a single Fibre Channel protocol port to appear as multiple, distinct ports, providing separate port identification within the fabric for each operating system image behind the port (as if each operating system image had its own unique physical port). NPIV assigns a different virtual port ID to each Fibre Channel protocol device. NPIV is designed to enable you to allocate virtual addresses without affecting your existing hardware implementation. The virtual port has the same properties as an N\_Port, and is therefore capable of registering with all services of the fabric. This chapter does not discuss the Access Gateway feature. For more information on the Access Gateway feature, refer to the *Access Gateway Administrator's Guide*.

Each NPIV device has a unique device PID, Port WWN, and Node WWN, and behaves the same as all other physical devices in the fabric. In other words, multiple virtual devices emulated by NPIV appear no different than regular devices connected to a non-NPIV port.

The same zoning rules apply to NPIV devices as non-NPIV devices. Zones can be defined by *domain,port* notation, by WWN zoning, or both. However, to perform zoning to the granularity of the virtual N\_Port IDs, you must use WWN-based zoning.

If you are using *domain,port* zoning for an NPIV port, and all the virtual PIDs associated with the port are included in the zone, then a port login (PLOGI) to a non-existent virtual PID is not blocked by the switch; rather, it is delivered to the device attached to the NPIV port. In cases where the device is not capable of handling such unexpected PLOGIs, use WWN-based zoning.

The following example shows the number of NPIV devices in the output of the **switchShow** command. The number of NPIV devices is equal to the sum of the base port plus the number of NPIV public devices. The base port is the N\_Port listed in the **switchShow** output. Based on the formula, index 010000 shows only 1 NPIV device and index 010300 shows a total of 222 NPIV devices (one N\_Port flogi device and 221 NPIV devices).

### Example of NPIV devices

```
switch:admin> switchshow
switchName:      5100
switchType:      71.2
switchState:     Online
switchMode:      Access Gateway Mode
switchWwn:       10:00:00:05:1e:41:49:3d
switchBeacon:    OFF
```

```

Index Port Address Media Speed State Proto
=====
0 0 010000 id N4 Online FC F-Port 20:0c:00:05:1e:05:de:e40xa06601
1 1 010100 id N4 Online FC F-Port 1 N Port + 4 NPIV public
2 2 010200 id N4 Online FC F-Port 1 N Port + 119 NPIV public
3 3 010300 id N4 Online FC F-Port 1 N Port + 221 NPIV public
    
```

On the Brocade DCX and DCX-4S with the FC8-64 blade, the base port is not included in the NPIV device count. The following example shows 63 NPIV devices total.

```

Index Slot Port Address Media Speed State Proto
=====
127 12 15 a07f40 id N4 Online FC F-Port 1 N Port + 63 NPIV public
(AoQ)
    
```

## Upgrade considerations

The maximum logins per switch has decreased with Fabric OS v6.4.0. When upgrading from a release previous to Fabric OS v6.4.0 and later, the configured maximum is carried forward and may exceed the Fabric OS v6.4.0 limit. It is recommended to reconfigure this parameter to be within the range permitted in Fabric OS v6.4.0 and later.

## Fixed addressing mode

Fixed addressing mode is the default addressing mode used in all platforms that do not have Virtual Fabrics enabled. When Virtual Fabrics is enabled on the Brocade DCX and DCX-4S, fixed addressing mode is used only on the default logical switch. The number of NPIV devices supported on shared area ports (48-port blades) is reduced to 64 from 128 when Virtual Fabrics mode is enabled.

## 10-bit addressing mode

The 10-bit addressing mode is the default mode for all the logical switches created in the Brocade DCX and DCX-4S Backbones. The number of NPIV or loop devices supported on a port is 64.

[Table 60](#) shows the number of NPIV devices supported on the Brocade DCX and DCX-4S Backbone.

**TABLE 60** Number of supported NPIV devices

Platform	Virtual Fabrics	Logical switch type	NPIV support
DCX	Disabled	N/A	Yes, 127 virtual device limit. <sup>1</sup>
DCX	Enabled	Default switch	Yes, 63 virtual device limit. <sup>1</sup>
DCX	Enabled	Logical switch	Yes, 255 virtual device limit. <sup>2, 3</sup>
DCX	Enabled	Base switch	No.
DCX-4S	Disabled	N/A	Yes, 255 virtual device limit.
DCX-4S	Enabled	Default switch	Yes, 255 virtual device limit.

**TABLE 60** Number of supported NPIV devices (Continued)

Platform	Virtual Fabrics	Logical switch type	NPIV support
DCX-4S	Enabled	Logical switch	Yes, 255 virtual device limit. <sup>3</sup>
DCX-4S	Enabled	Base switch	No.

1. Maximum limit support takes precedence if user-configured maximum limit is greater. This applies to shared areas on the FC4-48, FC8-48 and FC8-64 port blades.
2. The first 112 physical NPIV-capable devices connected to a logical switch using 10-bit addressing can log in 255 logical devices. The physical NPIV-capable devices after 112, 113, and higher, are limited to 63 logical devices.
3. Maximum limit of 63 for 10-bit areas connected to third-party (non-Brocade) NPIV HBAs.

## Configuring NPIV

The NPIV feature is enabled by default. You can set the number of virtual N\_Port\_IDs per port to a value between 1 through 255 per port. The default setting is 126.

The `portCfgNpivPort` command is be used to specify the maximum number of virtual N\_port\_IDs per port on a switch. It can also be used to enable to disable NPIV. Once NPIV is enabled on the port, you can specify the number of logins per port. If the feature has been disabled, then the NPIV port configuration does not work.

The addressing mode can limit the maximum number of NPIV logins to 127 or 63 depending on the mode. The `portCfgNPIVPort` command can set the maximum number of NPIV logins limit to anything from 1 through 255, regardless of the addressing mode. Whichever of these two (addressing mode or the value configured through `portCfgNPIVPort`) is lower will be the maximum number that can be logged in.



### CAUTION

**The `portDisable` command disables the port and stops all traffic flowing to and from the port. Perform this command during a scheduled maintenance.**

1. Connect to the switch and log in using an account assigned to the admin role.
2. Enter the `portDisable` command.
3. Enter the `portCfgNPIVPort --setloginlimit` command with the port number and the number of logins per port.
4. Press **Enter**.
5. Enter the `portEnable` command to enable the port.

#### Example of setting the login limit

```
switch:adnin> portcfgnpivport --setloginlimit 7/0 128
NPIV Limit Set to 128 for Port 128

switch:adnin> portcfgshow 7/0
Area Number:                128
Octet Speed Combo:          1 (16G|8G|4G|2G)
Speed Level:                 AUTO (SW)
AL_PA Offset 13:            OFF
Trunk Port                   ON
Long Distance                OFF
```

## 15 Enabling and disabling NPIV

VC Link Init	OFF
Locked L_Port	OFF
Locked G_Port	OFF
Disabled E_Port	OFF
Locked E_Port	OFF
ISL R_RDY Mode	OFF
RSCN Suppressed	OFF
Persistent Disable	OFF
LOS TOV enable	OFF
NPIV capability	ON
QOS E_Port	AE
Port Auto Disable:	OFF
Rate Limit	OFF
EX Port	OFF
Mirror Port	OFF
Credit Recovery	ON
F_Port Buffers	OFF
Fault Delay:	0 (R_A_TOV)
NPIV PP Limit:	128
CSCTL mode:	OFF
Frame Shooter Port	OFF
D-Port mode:	OFF
Compression:	OFF
Encryption:	OFF
FEC:	ON

## Enabling and disabling NPIV

On the Brocade 300, 5100, 5300, 6505, 6510, and 8000 switches, the Brocade 5410, 5424, 5450, 5460, 5470, and 5480 embedded switches, Brocade DCX and DCX 8510 Backbone families, and the FA4-18 blade, NPIV is enabled for every port.

---

### NOTE

NPIV is a requirement for FCoE. The CEE/FCoE ports on the Brocade 8000 have NPIV enabled by default, but NPIV cannot be enabled or disabled on these ports. The login limit can be set on these ports provided you disable and enable the ports using the **fcoe --disable** and **fcoe --enable** commands.

---

1. Connect to the switch and log in using an account assigned to the admin role.
2. To enable or disable NPIV on a port, enter the **portCfgNPIVPort** command with either the **--enable** or **--disable** option.

The following example shows NPIV being enabled on port 10 of a Brocade 5100:

```
switch:admin> portCfgNPIVPort --enable 10
```

---

### NOTE

If the NPIV feature is disabled, the port is toggled if NPIV devices are logged in from that F\_Port (a true NPIV port). Otherwise, the firmware considers that port as an F\_Port even though the NPIV feature was enabled.

---



## 15 Viewing NPIV port configuration information

```
portName: 02
portHealth: HEALTHY

Authentication: None
portDisableReason: None
portCFlags: 0x1
portFlags: 0x24b03 PRESENT ACTIVE F_PORT G_PORT NPIV LOGICAL_ONLINE LOGIN
NOELP LED ACCEPT
portType: 10.0
portState: 1Online
portPhys: 6In_Sync
portScn: 32F_Port
port generation number: 148
portId: 630200
portIfId: 43020005
portWwn: 20:02:00:05:1e:35:37:40
portWwn of device(s) connected:
c0:50:76:ff:fb:00:16:fc
c0:50:76:ff:fb:00:16:f8
...
<output truncated>
...
c0:50:76:ff:fb:00:16:80
50:05:07:64:01:a0:73:b8
Distance: normal
portSpeed: N2Gbps

Interrupts: 0 Link_failure: 16 Frjt: 0
Unknown: 0 Loss_of_sync: 422 Fbsy: 0
Lli: 294803 Loss_of_sig: 808
Proc_rqrd: 0 Protocol_err: 0
Timed_out: 0 Invalid_word: 0
Rx_flushed: 0 Invalid_crc: 0
Tx_unavail: 0 Delim_err: 0
Free_buffer: 0 Address_err: 1458
Overrun: 0 Lr_in: 15
Suspended: 0 Lr_out: 17
Parity_err: 0 Ols_in: 16
2_parity_err: 0 Ols_out: 15
CMI_bus_err: 0
```

## Viewing virtual PID login information

Use the **portLoginShow** command to display the login information for the virtual PIDs of a port. The following example is sample output from the **portLoginShow** command:

```
switch:admin> portloginshow 2
Type PID World Wide Name credit df_sz cos
=====
fe 630240 c0:50:76:ff:fb:00:16:fc 101 2048 c scr=3
fe 63023f c0:50:76:ff:fb:00:16:f8 101 2048 c scr=3
fe 63023e c0:50:76:ff:fb:00:17:ec 101 2048 c scr=3
...
<output truncated>
...
ff 630202 c0:50:76:ff:fb:00:17:70 192 2048 c d_id=FFFFFFC
ff 630201 c0:50:76:ff:fb:00:16:80 192 2048 c d_id=FFFFFFC
```

# Dynamic Fabric Provisioning: Fabric-Assigned WWN

---

## In this chapter

- [Introduction to Dynamic Fabric Provisioning using FA-PWWN](#) . . . . . 329
- [User- and auto-assigned FA-PWWN behavior](#) . . . . . 330
- [Configuring FA-PWWNs](#) . . . . . 330
- [Supported switches and configurations for FA-PWWN](#) . . . . . 333
- [Configuration upload and download considerations for FA-PWWN](#) . . . . . 334
- [Firmware upgrade and downgrade considerations for FA-PWWN](#) . . . . . 334
- [Security considerations for FA-PWWN](#) . . . . . 334
- [Restrictions of FA-PWWN](#) . . . . . 335
- [Access Gateway N\\_Port failover with FA-PWWN](#) . . . . . 335

## Introduction to Dynamic Fabric Provisioning using FA-PWWN

Fabric OS v7.0.0 introduces Dynamic Fabric Provisioning (DFP) to simplify server deployment in your Fibre Channel SAN (FC SAN) environment.

Server deployment typically requires that multiple administrative teams (for example, server and storage teams) coordinate with each other to perform configuration tasks such as zone creation in the fabric and LUN mapping and masking on the storage device. These tasks must be completed before the server is deployed. Before you can configure WWN zones and LUN masks, you must find out the physical port world wide name (PWWN) of the server. This means that administrative teams cannot start their configuration tasks until the physical server arrives (and its physical PWWN is known). Because the configuration tasks are sequential and interdependent across various administrative teams, it may take several days before the server gets deployed in an FC SAN.

Dynamic Fabric Provisioning simplifies and accelerates new server deployment and improves operational efficiency by using a fabric-assigned PWWN (FA-PWWN). An FA-PWWN is a “virtual” port WWN that can be used instead of the physical PWWN to create zoning and LUN mapping and masking. When the server is later attached to the SAN, the FA-PWWN is then assigned to the server.

The FA-PWWN feature allows you to perform the following tasks:

- Replace one server with another server, or replace failed HBAs or Adapters within a server, without having to change any zoning or LUN mapping and masking configurations.
- Easily move servers across ports or Access Gateways by way of reassigning the FA-PWWN to another port.
- Use the FA-PWWN to represent a server in boot LUN zone configurations so that any physical server that is mapped to this FA-PWWN can boot from that LUN, thus simplifying boot over SAN configuration.

---

**NOTE**

For the server to use the FA-PWWN feature, it must be using a Brocade HBA or Adapter. Refer to the release notes for the HBA or Adapter versions that support this feature.

Some configuration of the HBA must be performed to use the FA-PWWN.

---

## User- and auto-assigned FA-PWWN behavior

An FA-PWWN can be either user-generated or automatically assigned by the fabric. The automatically assigned FA-PWWN is created by default when you enable the feature without explicitly providing a virtual PWWN.

Each switch port and Access Gateway port can be assigned up to two WWNs, one assigned automatically and one assigned by the user. Only one FA-PWWN can be active at any given time. The user-assigned FA-PWWN takes precedence over the automatically assigned FA-PWWN. This means the switch will bind the user-assigned FA-PWWN to the port if both a user-assigned and an automatically assigned FA-PWWN are available. If you want to select the automatically assigned FA-PWWN over the user-assigned FA-PWWN, you must delete the user-assigned FA-PWWN from the port to which it has been assigned.

### Checking for duplicate FA-PWWNs

The switch ensures that automatically assigned FA-PWWNs are unique in a fabric. However, it is the responsibility of the administrators to ensure that user-assigned FA-PWWNs are also unique throughout the fabric.

---

**ATTENTION**

The administrators should ensure that the same user-assigned FA-PWWN is not used in multiple chassis. There is no fabric-wide database, and adding the same FA-PWWNs in multiple chassis causes duplicate PWWNs.

---

## Configuring FA-PWWNs

Use the **faPwwn** command to create and manage FA-PWWNs. The **faPwwn** command supports the following management tasks:

- Binding an automatically assigned or a user-assigned FA-PWWN to a switch port.
- Overriding an automatically assigned FA-PWWN with a user-assigned FA-PWWN.
- Binding an Access Gateway port with an automatically assigned or a user-assigned FA-PWWN.
- Deleting any existing FA-PWWN bindings.
- Moving an FA-PWWN from one port to another port.
- Moving an FA-PWWN assigned to an AG port to another AG.
- Displaying information about configured FA-PWWN bindings.

Refer to the *Fabric OS Command Reference* for information about using the **faPwwn** command.



This section includes an FA-PWWN configuration procedure for each of the following two topologies:

- An FA-PWWN for an HBA device that is connected to an Access Gateway switch.
- An FA-PWWN for an HBA device that is connected directly to an edge switch.

These topologies are shown in [Figure 50](#).

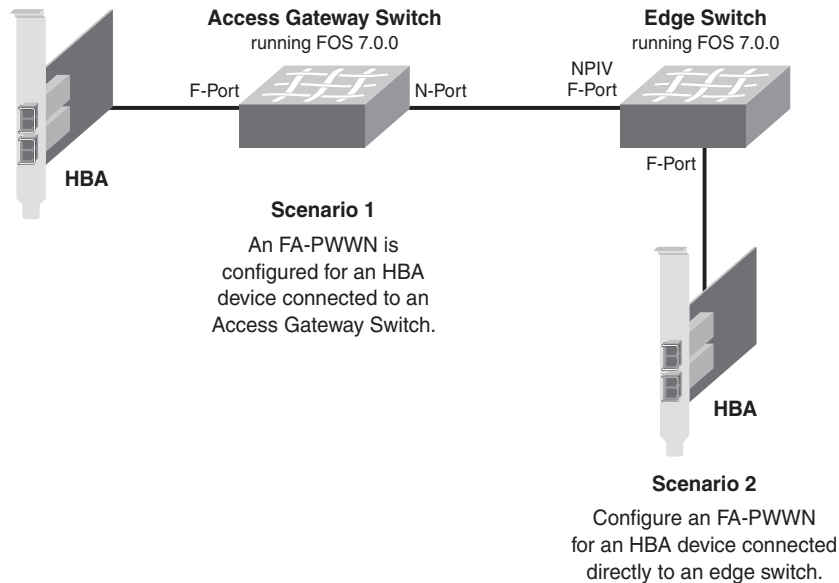

FIGURE 50 Fabric-assigned port world wide name provisioning scenarios

## Configuring an FA-PWWN for an HBA connected to an Access Gateway

For this procedure, some of the steps are to be executed on the switch and some are to be executed on the server.

1. Log in to the edge switch to which the Access Gateway is directly connected.
2. Assign the FA-PWWN.
  - If you are manually assigning a WWN, enter the following command:  
`fapwnn --assign -ag AG_WWN -port AG_port -v Virtual_PWWN`
  - If you want the WWN to be automatically assigned, enter the following command:  
`fapwnn --assign -ag AG_WWN -port AG_port`
3. Enter the following command:  
`fapwnn --show -ag all`

You should see output similar to the following sample. (In this example, long lines of output are shown split across two lines, for better readability.)

```
-----
      AG Port                Port      Device Port WWN      \
-----
10:00:00:05:1e:65:8a:d5/16  --      --:--:--:--:--:--:-- \
10:00:00:05:1e:d7:3d:dc/8   20      20:08:00:05:1e:d7:2b:74 \
-----
```

```

10:00:00:05:1e:d7:3d:dc/9    20    20:09:00:05:1e:d7:2b:73  \
10:00:00:05:1e:d7:3d:dc/16  --    --:--:--:--:--:--:--:-- \
-----
      Virtual Port WWN          PID  Enable MapType
-----
52:00:10:00:00:0f:50:30      --    Yes   AG/Auto
11:22:33:44:55:66:77:88     11403 Yes   AG/User
52:00:10:00:00:0f:50:32
2:00:10:00:00:0f:50:33       11404 Yes   AG/Auto
52:00:10:00:00:0f:50:38      --    Yes   AG/Auto

```

4. Enable the FA-PWWN on the HBA. The following steps are to be executed on the server and not the switch.

- a. Log in to the server as root.
- b. Enter the following command:

```
bcu port -faa port_id --enable
```

- c. Enter the following command:

```
bcu port -faa port_id --query
```

Once the Brocade HBA has been assigned the FA-PWWN, the HBA retains the FA-PWWN until rebooted. This means you cannot unplug and plug the cable into a different port on the AG. You must reboot the HBA before moving the HBA to a different port. If you move an HBA to a different port on a switch running Fabric OS v7.0.0 or later, the HBA will disable its port. If the HBA moves to a different port on a switch running a version of Fabric OS earlier than 7.0.0, the HBA will continue to disable its port.

## Configuring an FA-PWWN for an HBA connected to an edge switch

For this procedure, some of the steps are to be executed on the switch and some are to be executed on the server.

1. Log in to the edge switch to which the device is connected.
2. Assign the FA-PWWN.
  - If you are manually assigning a WWN, enter the following command:

```
fapwwn --assign -port [slot/]port -v Virtual_PWWN
```
  - If you want the WWN to be automatically assigned, enter the following command:

```
fapwwn --assign -port [slot/]port
```

3. Enter the following command:

```
fapwwn --show -port all
```

You should see output similar to the following sample.

```

-----
Port      PPWWN          VPWWN          PID Enable MapType
-----
0  --:--:--:--:--:--:--:--  52:00:10:00:00:0f:50:30  10101 Yes  Port/Auto
1  --:--:~:~:~:~:~:~:~:~  11:22:33:44:33:22:11:22  --   Yes  Port/User
                        52:00:10:00:00:0f:50:44
10 --:~:~:~:~:~:~:~:~:~:~  52:00:10:00:00:0f:50:45  --   Yes  Port/Auto

```

4. Enable the FA-PWWN on the HBA. The following steps are to be executed on the server and not the switch.
  - a. Log in to the server as root.
  - b. Enter the following command:

```
bcu port -faa port_id --enable
```
  - c. Enter the following command:

```
bcu port -faa port_id --query
```

Once the Brocade HBA has been assigned the FA-PWWN, the HBA retains the FA-PWWN until it is rebooted. This means you cannot unplug and plug the cable into a different port on the switch. You must reboot the HBA before moving the HBA to a different port. If you move an HBA to a different port on a switch running Fabric OS v7.0.0 or later, the HBA will disable its port. If the HBA moves to a different port on a switch running a version of Fabric OS earlier than 7.0.0, the HBA will continue to disable its port.

## Supported switches and configurations for FA-PWWN

The FA-PWWN feature is supported on the following platforms:

- Switch platforms running Fabric OS v7.0.0 or later:
  - Brocade DCX, DCX-4S, and DCX 8510 family
  - Brocade 300
  - Brocade 5100
  - Brocade 5300
  - Brocade 6505
  - Brocade 6510
  - Brocade VA-40FC
- Access Gateway platforms running Fabric OS v7.0.0 or later:
  - Brocade 300
  - Brocade 5100
  - Brocade 6510
- Brocade HBAs with driver version 3.0.0.0:
  - Brocade 415
  - Brocade 425
  - Brocade 815
  - Brocade 825

## Configuration upload and download considerations for FA-PWWN

The configuration upload and download utilities can be used to import and export the FA-PWWN configuration.

---

### ATTENTION

Brocade recommends you delete all FA-PWWNs from the switch with the configuration being replaced before you upload or download a modified configuration. This is to ensure no duplicate FA-PWWNs in the fabric.

---

## Firmware upgrade and downgrade considerations for FA-PWWN

Firmware downgrade is blocked if the FA-PWWN feature is enabled on the switch. All FA-PWWN configurations are lost if firmware is downgraded, followed by an upgrade back to Fabric OS v7.0.0. This is done to ensure that the FA-PWWN configurations are not tampered with when the switch is running an earlier version of the firmware.

You must also consider zone configuration, security configuration, and target ACLs when downgrading from Fabric OS 7.0.0. If any of these (zone configuration, security configuration, and target ACLs) have FA-PWWNs configured, the SAN network may not function properly, or at all.

## Security considerations for FA-PWWN

The FA-PWWN feature can be enabled only by authorized administrators. Thus, existing user-level authentication and authorization mechanisms should be used to ensure only authorized users can configure this feature.

If you are concerned about security for FA-PWWN, you should configure device authentication. You can use authentication at the device level to ensure security between the switch and the server. Refer to [“Device authentication policy”](#) on page 146 for information about configuring device authentication.

You can also use the Device Connection Control (DCC) policy to ensure that only an authorized physical server can connect to a specific switch port.

---

### NOTE

When creating the DCC policy, use the physical device WWN and not the FA-PWWN.

---

If you use DCC, a policy check is done on the physical PWWN on the servers. In the case of an HBA, the FA-PWWN is assigned to the HBA only *after* the DCC check is successful.

Refer to [“DCC policy behavior with Fabric-Assigned PWWNs”](#) on page 141 for additional information.

## Restrictions of FA-PWWN

Note the following restrictions when using the FA-PWWN feature:

- FA-PWWN is supported only on Brocade HBAs and Adapters. Refer to the release notes for the supported Brocade HBA or Adapter versions.
- FA-PWWN is not supported for the following:
  - FCoE devices
  - FL\_Ports
  - Swapped ports (using the **portswap** command)
  - Cascaded Access Gateway topologies
  - FICON/FMS mode
  - With F\_Port trunking on directly attached Brocade HBAs/Adapters

---

**NOTE**

FA-PWWN is supported with F\_Port trunking on the supported Access Gateway platforms.

---

## Access Gateway N\_Port failover with FA-PWWN

If an FA-PWWN F\_Port on an Access Gateway fails over to an N\_Port that is connected to a different switch, the FA-PWWN of that Access Gateway F\_Port must also be configured on that switch. If not, the FA-PWWN assigned to the Access Gateway F\_Port following a failover will be different than it was before the failover occurred. This situation may require the host to reboot to bring it back online. Even after the reboot, the host may potentially go into a different zone because the FA-PWWN is different.

## 16 Access Gateway N\_Port failover with FA-PWWN

# Managing Administrative Domains

---

## In this chapter

- [Administrative Domains overview](#) ..... 337
- [Admin Domain management for physical fabric administrators](#) ..... 346
- [SAN management with Admin Domains](#) ..... 358

## Administrative Domains overview

An *Administrative Domain* (Admin Domain or AD) is a logical grouping of fabric elements that defines which switches, ports, and devices you can view and modify. An Admin Domain is a filtered administrative view of the fabric.

---

### NOTE

If you do not implement Admin Domains, the feature has no impact on users and you can ignore this chapter.

---

Admin Domains permit access to a configured set of users. Using Admin Domains, you can partition the fabric into logical groups and allocate administration of these groups to different user accounts. These accounts can manage only the Admin Domains assigned to them and cannot make changes to the rest of the fabric.

For example, you can put all the devices in a particular department in the same Admin Domain for ease of managing those devices. If you have remote sites, you could put the resources in the remote site in an Admin Domain and assign the remote site administrator to manage those resources.

Admin Domains and Virtual Fabrics are mutually exclusive and are not supported at the same time on a switch.

Do not confuse Admin Domains with zones:

- Zones define which devices and hosts can communicate with each other.
- Admin Domains define which users can manage which devices, hosts, and switches.

You can have up to 256 Admin Domains in a fabric (254 user-defined and 2 system-defined), numbered from 0 through 255.

Admin Domains are designated by a name and a number. This document refers to specific Admin Domains using the format “AD $n$ ” where  $n$  is a number between 0 and 255.

---

### ATTENTION

The Admin Domain administrator can define up to 254 ADs (AD1 through AD254) in the AD database; however, it is recommended that no more than 16 active Admin Domains run concurrently. More than 16 active Admin Domains might cause performance degradation and unpredictable system behavior.

---

**NOTE**

Do not confuse an *Admin Domain number* with the *domain ID* of a switch. They are two different identifiers. The Admin Domain number identifies the Admin Domain and has a range from 0 through 255. The domain ID identifies a switch in the fabric and has a range from 1 through 239.

Figure 51 shows a fabric with two Admin Domains: AD1 and AD2.

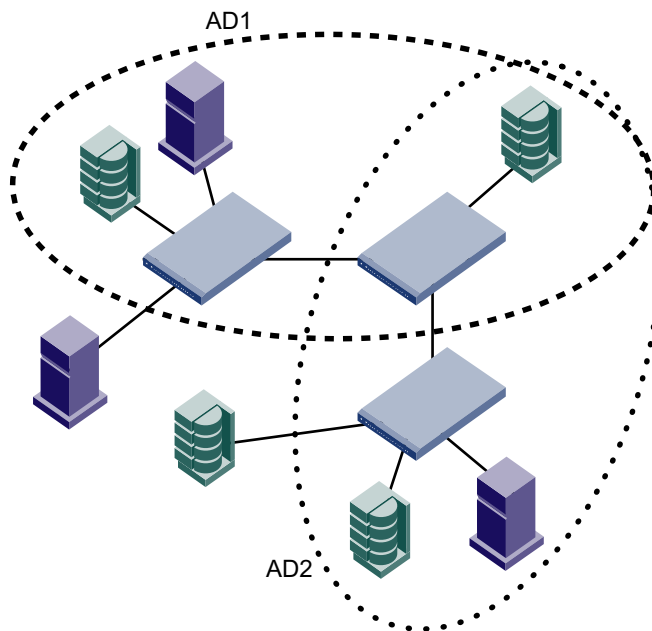

**FIGURE 51** Fabric with two Admin Domains

Figure 52 shows how users get a filtered view of this fabric, depending on which Admin Domain they are in. As shown in Figure 52, users can see all switches and E\_Ports in the fabric, regardless of their Admin Domain; however, the switch ports and end devices are filtered based on Admin Domain membership.

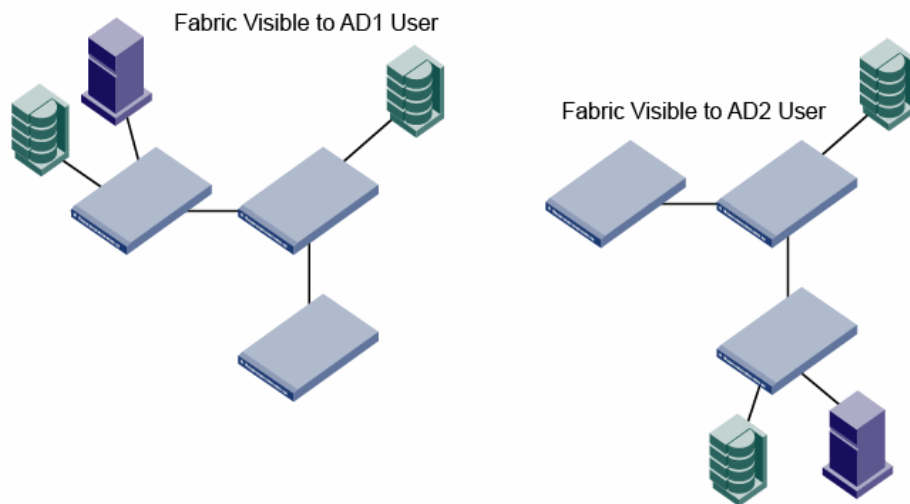

**FIGURE 52** Filtered fabric views when using Admin Domains



## Admin Domain features

Admin Domains allow you to do the following:

- Define the scope of an Admin Domain to encompass ports and devices within a switch or a fabric.
- Share resources across multiple Admin Domains. For example, you can share array ports and tape drives between multiple departments. In [Figure 51](#) on page 338, one of the storage devices is shared between AD1 and AD2.
- Have a separate zone database for each Admin Domain. Refer to [“Admin Domains, zones, and zone databases”](#) on page 362 for more information.
- Move devices from one Admin Domain to another without traffic disruption, cable reconnects, or discontinuity in zone enforcement.
- Provide strong fault and event isolation between Admin Domains.
- Have visibility of all physical fabric resources. All switches, E\_Ports, and FRUs (including blade information) are visible.
- Continue to run existing third-party management applications. Prior and existing versions of third-party management applications continue to work with admin IDs and user IDs.

## Requirements for Admin Domains

Implementing Admin Domains in a fabric has the following requirements:

- Admin Domains are not supported on the Brocade 8000. The Brocade 8000 can be in ADO only.
- The default zone mode setting must be set to No Access before you create Admin Domains (refer to [“Setting the default zoning mode for Admin Domains”](#) on page 346 for instructions).
- Virtual Fabrics must be disabled before you create Admin Domains (refer to [“Disabling Virtual Fabrics mode”](#) on page 226 for instructions).
- Gigabit Ethernet (GbE) ports cannot be members of an Admin Domain.
- Traffic Isolation Zoning is supported within Admin Domains, with some restrictions, as described in [“Admin Domain considerations for Traffic Isolation Zoning”](#) on page 282.
- If the fabric includes LSAN zones:
  - The LSAN zone names must not end with “\_ADn”.
  - The LSAN zone names must not be longer than 57 characters.

Refer to [Chapter 24, “Using FC-FC Routing to Connect Fabrics,”](#) for information about the FC-FC Routing Service and LSAN zones.

## Admin Domain access levels

Admin Domains offer a hierarchy of administrative access. To manage Admin Domains, you must be a *physical fabric administrator*. A physical fabric administrator is a user with admin permissions and access to all Admin Domains (ADO through AD255). Only a physical fabric administrator can perform Admin Domain configuration and management.

Other administrative access is determined by your defined Role-Based Access Control (RBAC) role and AD membership. Your role determines your access level and permission to perform an operation. Your AD membership determines the fabric resources on which you can operate.

Table 61 lists each Admin Domain user type and describes its administrative access and capabilities.

**TABLE 61** AD user types

User type	Description
Physical fabric administrator	User account with admin permissions and with access to all Admin Domains (ADO through AD255). Creates and manages all Admin Domains. Assigns other administrators or users to each Admin Domain. The default admin account is the first physical fabric administrator. Only a physical fabric administrator can create other physical fabric administrators.
Administrative Domain users	Can be assigned to one or more Admin Domains. Manage the resources within their Admin Domains. If their role permits, can create user accounts and assign them to Admin Domains in their list. Cannot view other Admin Domain definitions. They can view only members of their own Admin Domains.

## User-defined Admin Domains

AD1 through AD254 are user-defined Admin Domains. These user-defined Admin Domains can be created only by a physical fabric administrator (refer to “Admin Domain access levels” on page 339 for more information).

In Figure 51 on page 338, AD1 and AD2 are user-defined Admin Domains.

## System-defined Admin Domains

ADO and AD255 are system-defined Admin Domains. ADO and AD255 always exist and cannot be deleted or renamed. They are reserved for use in creation and management of Admin Domains.

### *ADO*

ADO is a system-defined Admin Domain. Unlike user-defined Admin Domains, ADO has an implicit and an explicit membership list. User-defined Admin Domains have only an explicit membership list.

- The *implicit membership list* contains all devices, switch ports, and switches that have not been assigned to any other Admin Domain.  
Initially, the ADO implicit membership list contains all devices, switch ports, and switches in the fabric. When you create AD1 through AD254, the devices, switch ports, and switches used to create these user-defined Admin Domains disappear from the ADO implicit membership list.
- The *explicit membership list* contains all devices, switch ports, and switches that you explicitly add to ADO and can be used to force device and switch sharing between ADO and other Admin Domains.

ADO is managed like any user-defined Admin Domain. The only difference between ADO and user-defined Admin Domains is the implicit membership list.

The implicit members of ADO change dynamically as the membership of other Admin Domains changes. The explicit members of ADO are not deleted unless you explicitly remove them.

For example, if DeviceA is not a member of any user-defined Admin Domain, then it is an implicit member of ADO.

If you explicitly add DeviceA to ADO, then DeviceA is both an implicit and an explicit member of ADO.

<u>ADO implicit members</u>	<u>ADO explicit members</u>	<u>AD2 members</u>
DeviceA	DeviceA	none

If you add DeviceA to AD2, then DeviceA is deleted from the ADO implicit membership list, but is *not* deleted from the ADO explicit membership list.

<u>ADO implicit members</u>	<u>ADO explicit members</u>	<u>AD2 members</u>
none	DeviceA	DeviceA

If you then remove DeviceA from AD2, DeviceA is added back to the ADO implicit membership list (assuming DeviceA is not in any other Admin Domain).

<u>ADO implicit members</u>	<u>ADO explicit members</u>	<u>AD2 members</u>
DeviceA	DeviceA	none

When a new device is added to the fabric, it automatically becomes an implicit member of ADO until it is explicitly added to an Admin Domain.

ADO is useful when you create Admin Domains because you can see which devices, switch ports, and switches are not yet assigned to any Admin Domains.

ADO owns the root zone database (legacy zone database).

## ***AD255***

AD255 is a system-defined Admin Domain that is used for Admin Domain management. AD255 always contains all of the devices in the entire physical fabric. You can use AD255 to get an unfiltered view of the fabric and to view the hierarchical zone databases of ADO through AD254. All Admin Domain management is done in the AD255 context.

AD255 does not have a zone database associated with it; you cannot use AD255 to perform any zoning management tasks (non-read operations such as creating or modifying zones).

[Figure 53](#) on page 342 shows the same fabric from [Figure 51](#) on page 338, but with ADO and AD255 shown. ADO contains the two devices that are not in any of the user-defined Admin Domains (AD1 and AD2). AD255 always encompasses the entire physical fabric.

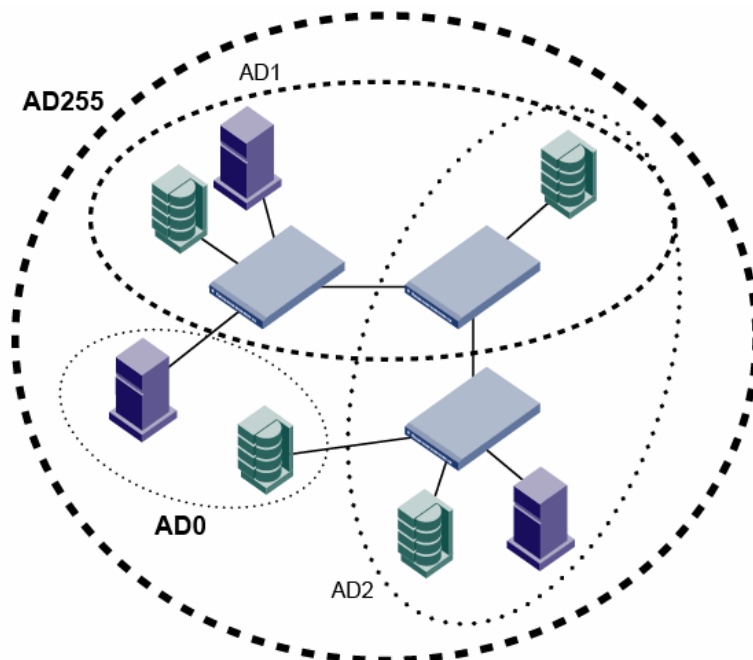

FIGURE 53 Fabric with AD0 and AD255

## Home Admin Domains and login

You are always logged in to an Admin Domain, and you can view and modify only the devices in that Admin Domain.

If you have access to more than one Admin Domain, one of them is designated as your *home Admin Domain*, the one you are automatically logged in to. If your home Admin Domain is deleted or deactivated, then by default you are logged in to the lowest-numbered active Admin Domain in your Admin Domain list. The home Admin Domain, like the Admin Domain list, is a configurable property of a non-default user account. Here is some additional information about AD accounts:

- You can log in to only one Admin Domain at a time. You can later switch to a different Admin Domain (refer to [“Switching to a different Admin Domain context”](#) on page 360 for instructions).
- For default accounts such as admin and user, the home Admin Domain defaults to AD0 and cannot be changed.
- The Admin Domain list for the default admin account is 0 through 255, which gives this account automatic access to any Admin Domain as soon as the domain is created, and makes this account a physical fabric administrator.
- The Admin Domain list for the default user account is AD0 only.
- For user-defined accounts, the home Admin Domain defaults to AD0 but an administrator can set the home Admin Domain to any Admin Domain to which the account is given access.
- If you are in any Admin Domain context other than AD0, the Admin Domain number is included in the system prompt displayed during your session. The following are example prompts for when you are in the AD0, AD1, and AD255 contexts, respectively:

```
switch:admin>
switch:AD1:admin>
switch:AD255:admin>
```

## Admin Domain member types

You define an Admin Domain by identifying members of that domain. Admin Domain members can be devices, switch ports, or switches. Defining these member types is similar to defining a traditional zone member type. An Admin Domain does not require or have a new domain ID or management IP address linked to it.

### *Device members*

Device members are defined by the device World Wide Name (WWN) and have the following properties:

- A device member can be either a device port WWN or a device node WWN.
- A device member grants view access to the device and zoning rights. View rights are also granted to the switch port to which the device is attached.
- A device member provides a pure virtual view. The cabling and switch port diagnostics and control are done by the physical fabric administrator.

Port control is provided only through switch port membership and is not provided for device members. When you create an Admin Domain, the end device members do not need to be online, even though their WWNs are used in the Admin Domain definition.

You can share device members across multiple Admin Domains. You can also zone shared devices differently in each Admin Domain. A device WWN member does not automatically grant usage of corresponding *domain,index* members in the zone configuration. If you specify a device WWN member in the Admin Domain member list, zone enforcement ignores zones with the corresponding port (the port to which the device is connected) member usage.

### *Switch port members*

Switch port members are defined by switch *domain,index* and have the following properties:

- A switch port member grants port control rights and zoning rights for that switch port.
- A switch port member grants view access and zoning rights to the device connected to that switch port.
- A switch port member allows you to share *domain,index* members across multiple Admin Domains. In each Admin Domain, you can also zone shared devices differently.
- A switch port member implicitly includes all devices connected to the specified *domain,index* members in the Admin Domain membership.
- A switch port member allows you to specify a range of indices as Admin Domain members, for example: 100, 5-8. The index range arguments are expanded and stored in the Admin Domain member list.

If a device is a member of an Admin Domain, the switch port to which the device is connected becomes an indirect member of that Admin Domain and the *domain,index* is removed from the ADO implicit membership list.

---

#### NOTE

If the switch domain ID changes, the *domain,index* members are invalid (they are not automatically changed). You must then reconfigure the Admin Domain with the current *domain,index* members.

---

### *Switch members*

Switch members are defined by the switch WWN or domain ID, and have the following properties:

- A switch member grants administrative control to the switch.
- A switch member grants port control for all ports in that switch.
- A switch member allows switch administrative operations such as disabling and enabling a switch, rebooting, and firmware downloads.
- A switch member does not provide zoning rights for the switch ports or devices.

To allow devices to be zoned within Admin Domains, you must specify the port members using *domain,index* or device WWN members.

E\_Ports (including VE\_Ports, EX\_Ports, and VEX\_Ports) are implicitly shared across all Admin Domains. An administrator can perform port control operations only if the *domain,index* of the E\_Port is part of the Admin Domain.

---

#### **NOTE**

Only the WWN of the switch is saved in the Admin Domain. If you change the domain ID of the switch, the Admin Domain ownership of the switch is not changed.

---

## **Admin Domains and switch WWNs**

Admin Domains are treated as fabrics. Because switches cannot belong to more than one fabric, switch WWNs are converted so that they appear as unique entities in different Admin Domains (fabrics). This WWN conversion is done only in the AD1 through AD254 context. ADO and AD255 use unconverted switch WWNs.

The switch WWN has the following format:

`10:00:nn:nn:nn:nn:nn:nn`

In an Admin Domain context, the switch WWN is converted from NAA=1 to NAA=5 format, with the Admin Domain number added, using the following syntax:

`5n:nn:nn:nn:nn:nn:n9:xx`

In the syntax, *xx* is the Admin Domain number.

For example, the following switch WWN is in NAA=1 format:

`10:00:00:60:69:e4:24:e0`

The following switch WWN is the converted WWN for the previous example in AD1:

`50:06:06:9e:42:4e:09:01`

[Figure 54](#) on page 345 shows an unfiltered view of a fabric with two switches, three devices, and two Admin Domains. The devices are labeled with device WWNs and the switches are labeled with domain IDs and switch WWNs.

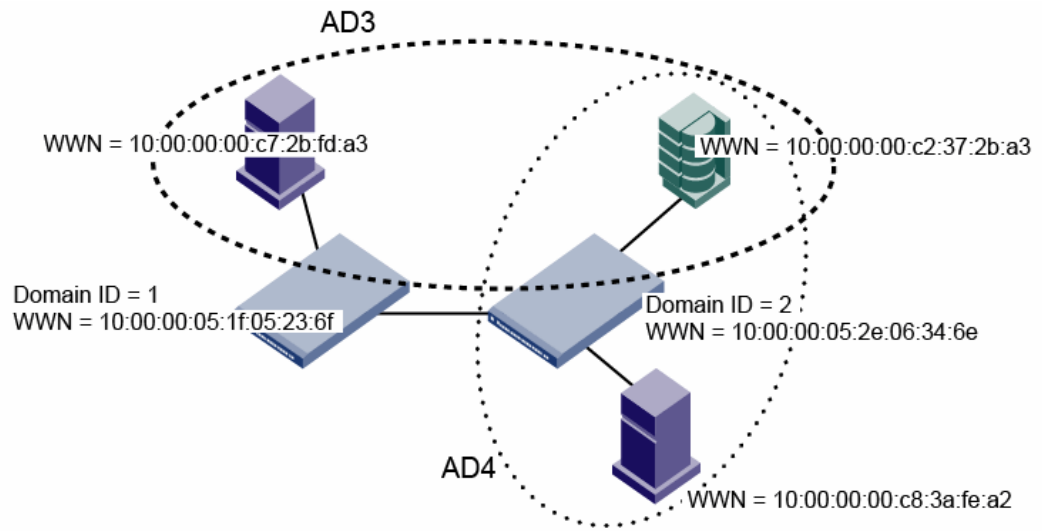

FIGURE 54 Fabric showing switch and device WWNs

Figure 55 shows the filtered view of the fabric as seen from AD3 and AD4. The switch WWNs are converted to the NAA=5 syntax; the device WWNs and domain IDs remain the same.

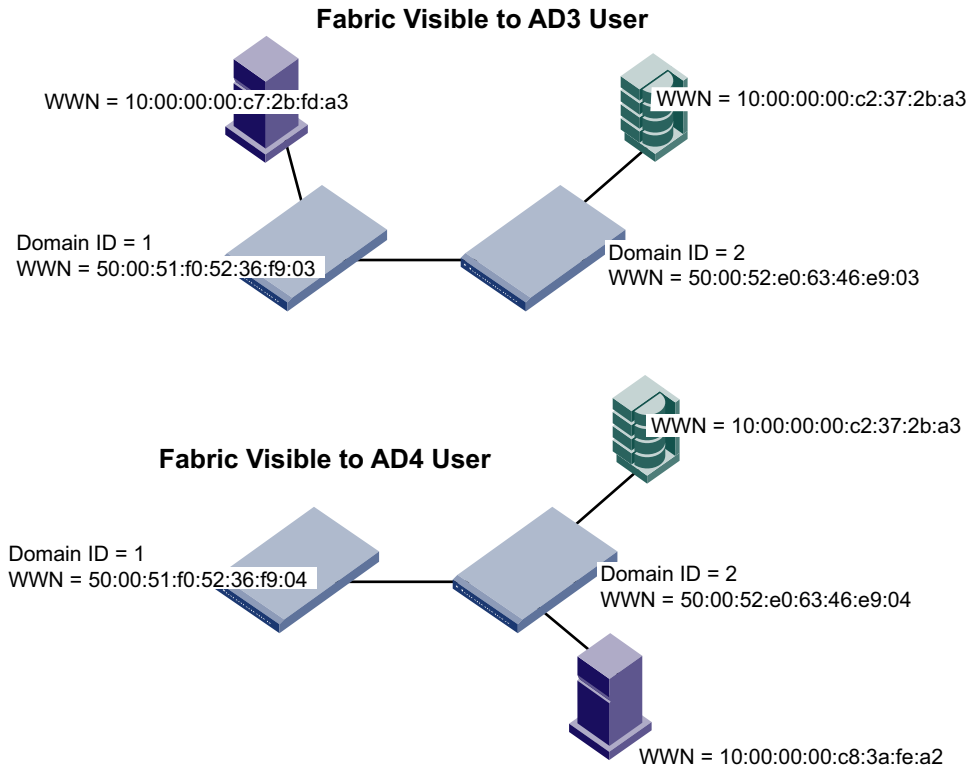

FIGURE 55 Filtered fabric views showing converted switch WWNs

## Admin Domain compatibility, availability, and merging

Admin Domains maintain continuity of service for Fabric OS features and operate in mixed-release Fabric OS environments. High availability is supported with some backward compatibility.

When an E\_Port comes online, the adjacent switches merge their AD databases. The receiving switch accepts an AD database from the neighboring switch only if the local AD database is empty or if the new AD database exactly matches both the defined and effective configurations of the local AD database. If the AD database merge fails, the E\_Port is segmented with an “AD conflict” error code.

## Admin Domain management for physical fabric administrators

---

### NOTE

This section is for physical fabric administrators who are managing Admin Domains.

---

The **ad** command follows a batched-transaction model, which means that changes to the Admin Domain configuration occur in the transaction buffer.

An Admin Domain configuration can exist in several places:

- Effective configuration — The Admin Domain configuration that is currently in effect.
- Defined configuration — The Admin Domain configuration that is saved in flash memory. There might be differences between the effective configuration and the defined configuration.
- Transaction buffer — The Admin Domain configuration that is in the current transaction buffer and has not yet been saved or canceled.

How you end the transaction determines the disposition of the Admin Domain configuration in the transaction buffer. The following commands end the Admin Domain transaction:

- |                        |   |
|------------------------|---|
| <b>ad --save</b>       | Saves the changes in the transaction buffer to the defined configuration in persistent storage and propagates the defined configuration to all switches in the fabric. Note that for <b>delete</b> and <b>clear</b> operations, if one or more of the deleted Admin Domains are in the effective configuration, you cannot use <b>--save</b> , but must use <b>--apply</b> instead. |
| <b>ad --apply</b>      | Saves the changes to the defined configuration in persistent storage and enforces the defined configuration on all switches in the fabric, replacing the effective configuration.   |
| <b>ad --transabort</b> | Aborts the transaction and clears the transaction buffer. The effective and defined configurations remain unchanged.  |

You can enter the **ad --transshow** command at any time to display the ID of the current Admin Domain transaction.

## Setting the default zoning mode for Admin Domains

To begin implementing an Admin Domain structure within your SAN, you must first set the default zoning mode to No Access. You must be in ADO to change the default zoning mode.



1. Log in to the switch with the appropriate RBAC role.
2. Ensure you are in the ADO context by entering the `ad --show` command to determine the current Admin Domain.  
If necessary, switch to the ADO context by entering the `ad --select 0` command.
3. Set the default zoning mode to No Access, as described in [“Setting the default zoning mode”](#) on page 253.

## Creating an Admin Domain

To create an Admin Domain, you must specify an Admin Domain name, number, or both:

- If you create an Admin Domain using only a number, the Admin Domain name is automatically assigned to be “AD $n$ ”, where  $n$  is the number you specified.

For example, if you specify AD number = 4, then AD name is set to “AD4”.

- If you create an Admin Domain using only a name, the Admin Domain number is automatically assigned and is the lowest available AD number, except if you specify a name in the format “AD $n$ ”, in which case the Admin Domain number is assigned to be  $n$ .

For example, if you specify AD name = “blueAD” and the lowest available AD number is 5, then AD name is “blueAD” and AD number is 5.

If you specify AD name = “AD15” and the lowest available AD number is 6, then AD name is “AD15” and AD number is 15. Because the specified name is in the format “AD $n$ ”, the AD number is assigned to be  $n$  and *not* the lowest available AD number.

When you create an Admin Domain, you must specify at least one member (switch, switch port, or device). You cannot create an empty Admin Domain. For more information about these member types, refer to [“Admin Domain member types”](#) on page 343.

A newly created Admin Domain has no zoning defined and the default access mode is No Access. This means the devices in the Admin Domain cannot communicate with each other. You must set up zones in the newly created Admin Domain to allow devices to access each other, even if the devices were already zoned together prior to your moving them to the Admin Domain. Refer to [“Admin Domains, zones, and zone databases”](#) on page 362 for additional information about how zones work with Admin Domains.

You create Admin Domains in the transaction buffer. You can either save the newly created Admin Domain to a defined configuration or make it the effective configuration directly.

The following procedure describes the steps for creating Admin Domains.

1. Log in to the switch as the physical fabric administrator.
2. Disable Virtual Fabrics, if necessary, as described in [“Disabling Virtual Fabrics mode”](#) on page 226. Admin Domains and Virtual Fabrics cannot co-exist.
3. Set the default zone mode to No Access, if you have not already done so. Refer to [“Setting the default zoning mode”](#) on page 253 for instructions.
4. Switch to the AD255 context, if you are not already in that context:

```
ad --select 255
```

5. Enter the **ad --create** command using the **-d** option to specify device and switch port members and the **-s** option to specify switch members:

```
ad --create ad_id -d "dev_list" -s "switch_list"
```

6. Enter the appropriate command based on whether you want to save or activate the Admin Domain definition:
  - To save the Admin Domain definition, enter **ad --save**.
  - To save the Admin Domain definition and directly apply the definition to the fabric, enter **ad --apply**.
7. Set up zones in the newly created Admin Domain. Refer to [Chapter 11, "Administering Advanced Zoning,"](#) for instructions.

### Example of creating Admin Domains

The following example creates Admin Domain AD1, consisting of two switches, which are designated by domain ID and switch WWN.

```
switch:AD255:admin> ad --create AD1 -s "97; 10:00:00:60:69:80:59:13"
```

The following example creates Admin Domain "blue\_ad," consisting of two switch ports (designated by *domain,index*), one device (designated by device WWN), and two switches (designated by domain ID and switch WWN).

```
switch:AD255:admin> ad --create blue_ad -d "100,5; 1,3;  
21:00:00:e0:8b:05:4d:05" -s "97; 10:00:00:60:69:80:59:13"
```

## User assignments to Admin Domains

After you create an Admin Domain, you can specify one or more user accounts as the valid accounts that can use that Admin Domain. User accounts have the following characteristics with regard to Admin Domains:

- A user account can have only a single role.
- You can configure a user account to have access to the physical fabric through AD255 and to a list of Admin Domains (AD0 through AD254).
- You can configure a user account to have access to only a subset of your own Admin Domain list. Only a physical fabric administrator can create another physical fabric administrator user account.
- Users capable of using multiple Admin Domains can designate one of these Admin Domains as the home Admin Domain, which is the default Admin Domain context after login.
- If you do not specify one, the home Admin Domain is the lowest valid Admin Domain in the numerically-sorted AD list.
- Users can log in to their Admin Domains and create their own Admin Domain-specific zones and zone configurations.

### *Creating a new user account for managing Admin Domains*

1. Connect to the switch and log in using an account with admin permissions.
2. Enter the **userConfig --add** command using the **-r** option to set the role, the **-a** option to provide access to Admin Domains, and the **-h** option to specify the home Admin Domain.

```
userconfig --add username -r role -h home_AD -a "AD_list"
```

#### **Example of creating new user accounts**

The following example creates new user account ad1admin with an admin role and assigns one Admin Domain, blue\_ad1, to it. This example also assigns blue\_ad1 as the user's home Admin Domain.

```
switch:admin> userconfig --add ad1admin -r admin -h blue_ad1 -a "blue_ad1"
```

The following example creates new user account ad2admin with an admin role, access to Admin Domains 1 and 2, and home Admin Domain set to 2.

```
switch:admin> userconfig --add ad2admin -r admin -h 2 -a "1,2"
```

### *Assigning Admin Domains to an existing user account*

1. Connect to the switch and log in using an account with admin permissions.
2. Enter the **userConfig --addad** command using the **-a** option to provide access to Admin Domains and the **-h** option to specify the home Admin Domain.

```
userconfig --addad username -h home_AD -a "AD_list"
```

#### **Example**

The following example assigns Admin Domain green\_ad2 to the existing user account ad1admin.

```
switch:admin> userconfig --addad ad1admin -a "green_ad2"
```

### *Creating a physical fabric administrator user account*

1. Connect to the switch and log in using an account with admin permissions.
2. Enter the **userConfig --add** command using the **-r** option to set the role to admin and the **-a** option to provide access to Admin Domains 0 through 255.

```
userconfig --add username -r admin -h home_AD -a "0-255"
```

#### **Example**

The following example creates new user account pfa\_admin1 with an admin role, access to all Admin Domains (AD0 through AD255), and home Admin Domain set to 255. This user account is now a physical fabric administrator.

```
switch:admin> userconfig --add pfa_admin1 -r admin -h 255 -a "0-255"
```

## Removing an Admin Domain from a user account

When you remove an Admin Domain from an account, all of the currently active sessions for that account are logged out.

1. Connect to the switch and log in using an account with admin permissions.
2. Enter the `userconfig --deletead` command:

```
userconfig --deletead username [-h admindomain_ID] [-a admindomain_ID_list]
```

If the `-h` argument is not specified, the home Admin Domain either remains as it was or becomes the lowest Admin Domain ID in the remaining list.

### Example of removing Admin Domain `green_ad2` from the user account `adm1`

```
switch:admin> userconfig --deletead adm1 -a "green_ad2"
```

```
Broadcast message from root (pts/0) Wed Jan 27 20:57:14 2010...
```

```
Security Policy, Password or Account Attribute Change: adm1 will be logged out  
Ads for account adm1 has been successfully deleted.
```

## Activating an Admin Domain

An Admin Domain can be in either an active or inactive state. When you create an Admin Domain, it is automatically in the active state.

1. Connect to the switch and log in using an account with admin permissions.
2. Switch to the AD255 context, if you are not already in that context.

```
ad --select 255
```

3. Enter the `ad --activate` command.

```
ad --activate ad_id
```

You are prompted for confirmation.

By default, after the Admin Domain is activated, the devices specified under that AD are not able to see each other until they are zoned together.

4. Enter the appropriate command based on whether you want to save or activate the Admin Domain definition:

- To save the Admin Domain definition, enter `ad --save`.
- To save the Admin Domain definition and directly apply the definition to the fabric, enter `ad --apply`.

### Example

The following example activates Admin Domain `AD_B5`.

```
switch:AD255:admin> ad --activate AD_B5  
You are about to activate a new admin domain.  
Do you want to activate 'AD_B5' admin domain (yes, y, no, n): [no]: y  
switch:AD255:admin>
```

## Deactivating an Admin Domain

If you deactivate an Admin Domain, the members assigned to the Admin Domain can no longer access their hosts or storage unless those members are part of another Admin Domain.

You cannot log in to an Admin Domain that has been deactivated. You must activate an Admin Domain before you can log in to it.

1. Connect to the switch and log in using an account with admin permissions.
2. Disable the zone configuration under the Admin Domain you want to deactivate.

```
cfgdisable
```

3. Switch to the AD255 context, if you are not already in that context.

```
ad --select 255
```

4. Enter the **ad --deactivate** command.

```
ad --deactivate ad_id
```

You are prompted for confirmation.

5. Enter the appropriate command based on whether you want to save or activate the Admin Domain definition:

- To save the Admin Domain definition, enter **ad --save**.
- To save the Admin Domain definition and directly apply the definition to the fabric, enter **ad --apply**.

All active user sessions associated with the Admin Domain are terminated. The **ad --deactivate** command does not disable ports.

### Example of deactivating Admin Domain AD\_B4

```
switch:AD255:admin> ad --deactivate AD_B4
You are about to deactivate an AD.
This operation will fail if an effective zone configuration exists in the AD
Do you want to deactivate 'AD_B5' admin domain (yes, y, no, n): [no] y
switch:AD255:admin>
```

## Adding members to an existing Admin Domain

1. Connect to the switch and log in using an account with admin permissions.
2. Switch to the AD255 context, if you are not already in that context.

```
ad --select 255
```

3. Enter the **ad --add** command using the **-d** option to specify device and switch port members and the **-s** option to specify switch members.

```
ad --add ad_id -d "dev_list" -s "switch_list"
```

In the syntax, *ad\_id* is the Admin Domain name or number, *dev\_list* is a list of device WWNs or *domain,index* members, and *switch\_list* is a list of switch WWNs or domain IDs.

4. Enter the appropriate command based on whether you want to save or activate the Admin Domain definition:
  - To save the Admin Domain definition, enter **ad --save**.
  - To save the Admin Domain definition and directly apply the definition to the fabric, enter **ad --apply**.

**Example of adding two switch ports, designated by *domain,index*, to AD1**

```
switch:AD255:admin> ad --add AD1 -d "100,5; 4,1"
```

## Removing members from an Admin Domain

If you remove the last member of an Admin Domain, that Admin Domain is automatically deleted.

1. Connect to the switch and log in using an account with admin permissions.
2. Switch to the AD255 context, if you are not already in that context.

```
ad --select 255
```

3. Enter the **ad --remove** command using the **-d** option to specify device and switch port members and the **-s** option to specify switch members.

```
ad --remove ad_id -d "dev_list" -s "switch_list"
```

Removing the last member element of an Admin Domain deletes the Admin Domain.

4. Enter the appropriate command based on whether you want to save or activate the Admin Domain definition:
  - To save the Admin Domain definition, enter **ad --save**.
  - To save the Admin Domain definition and directly apply the definition to the fabric, enter **ad --apply**.

### Example 1

The following example removes port 5 of domain 100 and port 3 of domain 1 from AD1.

```
switch:AD255:admin> ad --remove AD1 -d "100,5; 1,3"
```

### Example 2

The following example removes switch 100 from the membership list of AD4.

```
switch:AD255:admin> ad --remove AD4 -s "100"
```

## Renaming an Admin Domain

Use this procedure if you want to change the name of an Admin Domain. You can also change auto-assigned names (ADn).

The rename operation does not take effect if the Admin Domain you want to rename is part of the effective configuration.

1. Connect to the switch and log in using an account with admin permissions.
2. Switch to the AD255 context, if you are not already in that context.

```
ad --select 255
```

3. Enter the **ad --rename** command with the present name and the new name.

```
ad --rename present_name new_name
```

4. Enter the appropriate command based on whether you want to save or activate the Admin Domain definition:

- To save the Admin Domain definition, enter **ad --save**.
- To save the Admin Domain definition and directly apply the definition to the fabric, enter **ad --apply**.

The Admin Domain numbers remain unchanged after the operation.

#### Example of changing the name of Admin Domain Eng\_AD to Eng\_AD2

```
switch:AD255:admin> ad --rename Eng_AD Eng_AD2
```

## Deleting an Admin Domain

When you delete an Admin Domain, its devices no longer have access to the members of the zones with which it was associated.

1. Connect to the switch and log in using an account with admin permissions.
2. Switch to the Admin Domain that you want to delete.

```
ad --select ad_id
```

3. Enter the appropriate command to clear the zone database under the Admin Domain you want to delete.

- To remove the effective configuration, enter **cfgdisable**.
- To remove the defined configuration, enter **cfgclear**.
- To save the changes to nonvolatile memory, enter **cfgsave**.

4. Switch to the AD255 context.

```
ad --select 255
```

5. Enter the **ad --delete** command.

```
ad --delete ad_id
```

The **ad --delete** command prompts you for confirmation before triggering the deletion. The command succeeds whether the Admin Domain is in an activated or deactivated state.

6. Enter the **ad --apply** command to save the Admin Domain definition and directly apply the definition to the fabric.

#### Example of deleting Admin Domain AD\_B3

```
switch:AD255:admin> ad --delete AD_B3
You are about to delete an AD.
This operation will fail if zone configuration exists in the AD
Do you want to delete 'AD_B3' admin domain (yes, y, no, n): [no] y
switch:AD255:admin>
```

## Deleting all user-defined Admin Domains

When you clear the Admin Domain configuration, all user-defined Admin Domains are deleted, the explicit membership list of ADO is cleared, and all fabric resources (switches, ports, and devices) are returned to the implicit membership list of ADO.

You cannot clear the Admin Domain configuration if zone configurations exist in any of the user-defined Admin Domains.

If you want to remove all Admin Domains while retaining device connectivity (for example, if you want to enable Virtual Fabrics), use the procedure described in [“Deleting all user-defined Admin Domains non-disruptively.”](#)

1. Clear all individual AD zone databases, in separate transactions, before proceeding with this operation. Refer to [“Clearing all zone configurations”](#) on page 259 for instructions.
2. Connect to the switch and log in using an account with admin permissions.
3. Switch to the AD255 context, if you are not already in that context.

```
ad --select 255
```

4. Enter the **ad --clear** command.

This option prompts you for confirmation before triggering the deletion of all Admin Domains.

5. Enter the **ad --apply** command to save the Admin Domain definition and directly apply the definitions to the fabric.

### Example

```
switch:AD255:admin> ad --clear
You are about to delete all ADs definitions.
This operations will fail if zone configurations exists in AD1-AD254
Do you want to clear all admin domains (yes, y, no, n): [no] y
switch:AD255:admin>
```

## Deleting all user-defined Admin Domains non-disruptively

To disable Admin Domains non-disruptively, you must do the following before you clear the user-defined ADs:

- Create and activate zone configurations in ADO that are equivalent to the zone configurations in each of the user-defined ADs.
- Define all of the members that are currently in user-defined ADs in ADO.

This will ensure that the devices are able to communicate when they are removed from the user-defined ADs.

You can use this procedure to remove all Admin Domains before enabling Virtual Fabrics.

1. Connect to the switch and log in using an account with admin permissions.
2. Enter the **cfgshow** command in the AD255 context to display the zone configurations for all Admin Domains.

```
ad --exec 255 "cfgshow"
```



3. Enter the **zone --copy** command to copy the zones from all user-defined Admin Domains to ADO.

```
zone --copy source_AD.source_name dest_name
```

In this syntax, *source\_AD* is the name of the user-defined AD from which you are copying the zone, *source\_name* is the name of the zone to be copied, and *dest\_name* is the name to give to the zone after it is copied to ADO.

4. Copy the newly added zones in ADO to the zone configuration.

```
cfgadd "cfgName", "member[;member]"
```

5. Enable the configuration to complete the transaction.

```
cfgenable cfgName
```

6. Switch to the AD255 context.

```
ad --select 255
```

7. Explicitly add devices that are present in the user-defined ADs to ADO.

```
ad --add ADO -d "dev_list"
```

8. Enter the **ad --apply** command to save the Admin Domain definition and directly apply the definitions to the fabric.

```
ad --apply
```

At this point, all of the devices in the user-defined ADs are also defined and zoned in ADO.

9. Clear the user-defined ADs.

```
ad --clear -f
```

10. Enter the **ad --apply** command to save the Admin Domain definition and directly apply the definitions to the fabric.

```
ad --apply
```

All user-defined Admin Domains have now been removed, but all device communication that was allowed with the original Admin Domain configuration is still permitted in the context of ADO.

### Example

The following example assumes the configuration shown in [Figure 56](#) on page 356:

- Three Admin Domains: ADO, plus two user-defined Admin Domains (AD1 and AD2).
- ADO has two devices, WWN1 and WWN2, in the ADO\_RedZone.
- AD1 has two devices, WWN2 and WWN3, in the AD1\_BlueZone.
- AD2 has two devices, WWN4 and WWN5, in the AD2\_GreenZone.
- The device WWN2 is in both ADO and AD1.

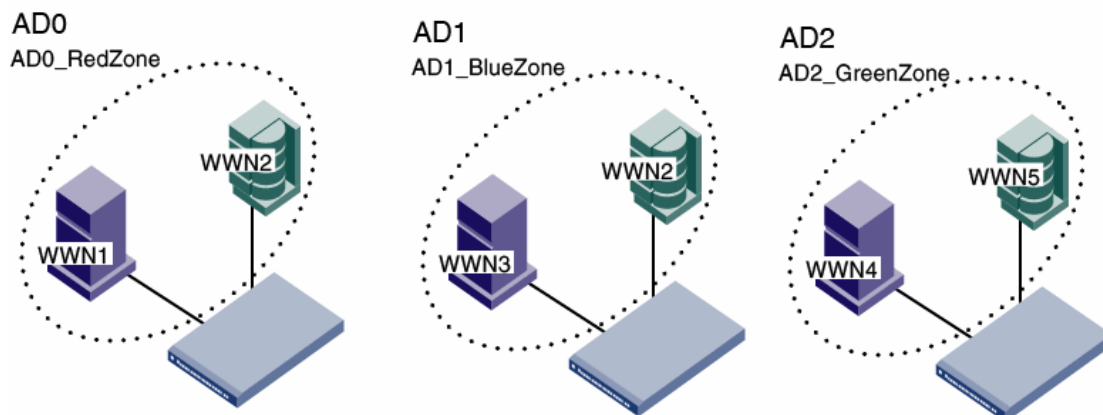

FIGURE 56 AD0 and two user-defined Admin Domains, AD1 and AD2

At the conclusion of the procedure, all devices and zones are moved to AD0, and the user-defined Admin Domains are deleted, as shown in Figure 57.

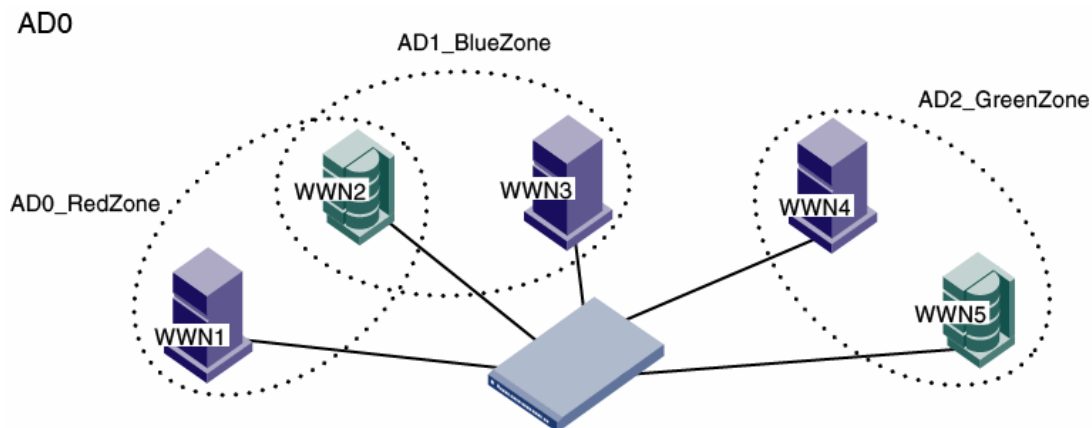

FIGURE 57 AD0 with three zones

```
sw0:admin> ad --exec 255 "cfgshow"

Zone CFG Info for AD_ID: 0 (AD Name: AD0, State: Active) :

Defined configuration:
cfg: AD0_cfg AD0_RedZone
zone: AD0_RedZone
      10:00:00:00:01:00:00:00; 10:00:00:00:02:00:00:00

Effective configuration:
cfg: AD0_cfg
zone: AD0_RedZone
      10:00:00:00:01:00:00:00
      10:00:00:00:02:00:00:00

Zone CFG Info for AD_ID: 1 (AD Name: AD1, State: Active) :

Defined configuration:
cfg: AD1_cfg AD1_BlueZone
zone: AD1_BlueZone
```

```

10:00:00:00:02:00:00:00; 10:00:00:00:03:00:00:00

Effective configuration:
  cfg:  AD1_cfg
  zone:  AD1_BlueZone
        10:00:00:00:02:00:00:00
        10:00:00:00:03:00:00:00

Zone CFG Info for AD_ID: 2    (AD Name: AD2, State: Active) :

Defined configuration:
  cfg:  AD2_cfg AD2_GreenZone
  zone:  AD2_GreenZone
        10:00:00:00:04:00:00:00; 10:00:00:00:05:00:00:00

Effective configuration:
  cfg:  AD2_cfg
  zone:  AD2_GreenZone
        10:00:00:00:04:00:00:00
        10:00:00:00:05:00:00:00

sw0:admin> zone --copy AD1.AD1_BlueZone AD0_BlueZone
sw0:admin> zone --copy AD2.AD2_GreenZone AD0_GreenZone
sw0:admin> cfgadd "AD0_cfg", "AD0_BlueZone; AD0_GreenZone"
sw0:admin> cfigenable AD0_cfg
You are about to enable a new zoning configuration.
This action will replace the old zoning configuration with the
current configuration selected. If the update includes changes
to one or more traffic isolation zones, the update may result in
localized disruption to traffic on ports associated with
the traffic isolation zone changes
Do you want to enable 'AD0_cfg' configuration (yes, y, no, n): [no] y
zone config "AD0_cfg" is in effect
Updating flash ...

sw0:admin> ad --select 255
sw0:AD255:admin> ad --add AD0 -d "10:00:00:00:03:00:00:00;
10:00:00:00:04:00:00:00; 10:00:00:00:05:00:00:00"
sw0:AD255:admin> ad --apply
You are about to enforce the saved AD configuration.
This action will trigger AD apply to all switches in the fabric
Do you want to apply all admin domains (yes, y, no, n): [no] y

sw0:AD255:admin> ad --clear -f
You are about to delete all ADs definitions and zone databases under them.
This could involve multiple independent zone transactions and
no auto recovery will be done in case of failure in the middle.
Do you want to clear all admin domains (yes, y, no, n): [no] y

sw0:AD255:admin> ad --apply
You are about to enforce the saved AD configuration.
This action will trigger AD apply to all switches in the fabric
Do you want to apply all admin domains (yes, y, no, n): [no] y

```

## Validating an Admin Domain member list

You can validate the device and switch member list. You can list non-existing or offline Admin Domain members. You can also identify misconfigurations of the Admin Domain.

The Admin Domain validation process is not applicable for ADO, because ADO implicitly contains all unassigned online switches and their devices.

1. Connect to the switch and log in using an account with admin permissions.
2. Switch to the AD255 context, if you are not already in that context.

```
ad --select 255
```

3. Enter the `ad --validate` command.

```
ad --validate ad_id -m mode
```

If you do not specify any parameters, the entire AD database (transaction buffer, defined configuration, and effective configuration) is displayed.

If you do not specify an Admin Domain, information about all existing Admin Domains is displayed.

The `-m mode` option can be used with the following values:

- 0 to display the Admin Domain configuration in the current transaction buffer.
- 1 to display the Admin Domain configuration stored in the persistent memory (defined configuration).
- 2 to display the currently enforced Admin Domain configuration (effective configuration).

### Example of validating the member list of Admin Domain 10 in the current transaction buffer

```
switch:AD255:admin> ad --validate 10 -m 0
Current AD Number: 255  AD Name: AD255

Transaction buffer configuration:
-----
AD Number:    2    AD Name: ad2    State: Active
      Switch port members:          1,1; 1,3; 2,5+; 3,6;
-----
* - Member does not exist
+ - Member is AD Unaware
```

## SAN management with Admin Domains

This section is for both users and administrators and describes how Admin Domains affect commands and other Fabric OS features. If you are a physical fabric administrator and you want to create, modify, or otherwise manage Admin Domains, refer to [“Admin Domain management for physical fabric administrators”](#) on page 346.

The Admin Domain looks like a virtual switch or fabric to a user. However, based on the user role and type (User\_ID), users are presented with only their relevant AD-based views (refer to [Figure 51](#) on page 338 and [Figure 52](#) on page 338). Any devices and switch ports that are not defined as part of the Admin Domain are not shown and are not available to that AD user.

Each Admin Domain can also have its own zone configurations (defined and effective) with zones and aliases under them.

## CLI commands in an AD context

The CLI command input arguments are validated against the AD member list; they do not work with input arguments that specify resources that are not members of the current Admin Domain. All commands present filtered output, showing only the members of the current Admin Domain.

For example, **switchShow** displays details for the list of AD members present in that switch. Note the following about the **switchShow** output:

- Because all E\_Ports and EX\_Ports are shared across all Admin Domains, they are shown under all Admin Domains.
- Other ports are displayed without any attribute details (with an explanation that they are not part of the current Admin Domain).

A port or device appears in CLI command output or other management tool outputs if any one of the conditions listed in [Table 62](#) is met.

**TABLE 62** Ports and devices in CLI output

For	Condition
<i>domain,index</i>	<ul style="list-style-type: none"> <li>• The port is specified in the <i>domain,index</i> member list of the Admin Domain.</li> <li>• One or more WWNs specified in the AD member list is attached to the <i>domain,index</i>.</li> </ul>
Device WWN	<ul style="list-style-type: none"> <li>• The device WWN is specified in the AD WWN member list.</li> <li>• The device WWN is attached to one of the <i>domain,index</i> members specified in the AD member list.</li> </ul>

RASlog and syslog output is not filtered based on AD membership.

Refer to the *Fabric OS Command Reference* for more detailed information about command syntax and usage and to understand how existing commands behave in an AD context.

## Executing a command in a different AD context

You can execute a command in an Admin Domain that is different from your current AD context. The Admin Domain must be one that you can access. This option creates a new shell with the current User\_ID, switches to the specified Admin Domain, performs the specified command, and exits the shell.

1. Connect to the switch and log in.
2. Enter the **ad --exec** command, specifying the Admin Domain and the command you want to execute.

```
ad --exec ad_id "command"
```

**Example of executing the switchShow command in the AD7 context**

```
switch:AD255:admin> ad --exec 7 "switchshow"
```

## Displaying an Admin Domain configuration

You can display the membership information and zone database information of a specified Admin Domain. Note the following differences in the information displayed based on the Admin Domain:

- AD255: If you do not specify the AD name or number, all information about all existing Admin Domains is displayed.

- ADO–AD254: The membership of the current Admin Domain is displayed.
  - ADO: The device and switch list members are categorized into implicit and explicit member lists.
1. Connect to the switch and log in as any user type.
  2. Enter the **ad --show** command.

```
ad --show
```

If you are in the ADO context, you can use the **-i** option to display the implicit membership list of ADO; otherwise, only the explicit membership list is displayed.

```
ad --show -i
```

If you are in the AD255 context, all Admin Domain configurations from the transaction buffer, defined configuration, and effective configuration are displayed, unless you use the **-m** option:

```
ad --show ad_id -m mode
```

In the syntax, *ad\_id* is the Admin Domain for which you want to display information and *mode* is one of the following values:

- 0 to display the Admin Domain configuration in the current transaction buffer.
- 1 to display the Admin Domain configuration stored in the persistent memory (defined configuration).
- 2 to display the currently enforced Admin Domain configuration (effective configuration).

### Example of displaying membership information about AD1

```
switch:AD1:admin> ad --show
Current AD Number: 1  AD Name: TheSwitches

Effective configuration:
-----

AD Number: 1 AD Name:   TheSwitches      State: Active

      Switch WWN members:                50:06:06:99:00:2a:e9:01;
                                           50:00:51:e0:23:36:f9:01;
                                           50:06:06:98:05:be:99:01;
```

## Switching to a different Admin Domain context

You can switch between different Admin Domain contexts. This option creates a new shell with a new Admin Domain context. If the corresponding Admin Domain is not activated, the operation fails.

1. Connect to the switch and log in as any user type.
2. Enter the **ad --select** command and the Admin Domain to which you want to switch.
3. Leave the new Admin Domain context by exiting from the shell.

```
logout
```

You cannot switch to another Admin Domain context from within the shell created by **ad --select**. You must first exit the shell, and then issue the **ad --select** command again.

**Example of switching to a different Admin Domain context**

The following example switches to the AD12 context and back. Note that the prompt changes to display the Admin Domain.

```
switch:admin> ad --select 12
switch:AD12:admin> logout
switch:admin>
```

**Admin Domain interactions with other Fabric OS features**

The Admin Domain feature provides interaction with other Fabric OS features and across third-party applications. You can manage Admin Domains with Web Tools as well as the CLI. If the current Admin Domain owns the switch, you can perform Fabric Watch operations.

Admin Domain interactions do not extend to user session tunneling across switches. A user logged in to a switch can control only the local switch ports as specified in the Admin Domain.

When the fabric is in secure mode, the following restrictions apply:

- There is no support for ACL configuration under each Administrative Domain.
- ACL configuration commands are allowed only in ADO and AD255. None of the policy configurations are validated with AD membership.

[Table 63](#) lists some of the Fabric OS features and considerations that apply when using Admin Domains.

**TABLE 63 Admin Domain interaction with Fabric OS features**

Fabric OS feature	Admin Domain interaction
ACLs	If no user-defined Admin Domains exist, you can run ACL configuration commands in only ADO and AD255. If any user-defined Admin Domains exist, you can run ACL configuration commands only in AD255. You <i>cannot</i> use ACL configuration commands or validate ACL policy configurations against AD membership under each Admin Domain.
Advanced Performance Monitoring (APM)	All APM-related filter setup and statistics viewing is allowed only if the local switch is part of the current Admin Domain.
Configuration upload and download	Refer to <a href="#">“Configuration upload and download in an AD context”</a> on page 364 for details.
Fabric Watch	Fabric Watch configuration operations are allowed only if the local switch is part of the current Admin Domain.
FC-FC Routing Service	You can create LSAN zones as a physical fabric administrator or as an individual AD administrator. The LSAN zone can be part of the root zone database or the AD zone database. FCR collects the LSAN zones from all ADs. If both edge fabrics have matching LSAN zones and both devices are online, FCR triggers a device import. LSAN zone enforcement in the local fabric occurs only if the AD member list contains both of the devices (local and imported devices) specified in the LSAN zone. To support legacy applications, WWNs are reported based on the AD context using NAA=5. As a result, you cannot use the NAA=5 field alone in the WWN to detect an FC router.
FDMI	FDMI operations are allowed only in ADO and AD255.

TABLE 63 Admin Domain interaction with Fabric OS features (Continued)

Fabric OS feature	Admin Domain interaction
FICON	Admin Domains support FICON. However, you must perform additional steps because FICON management requires additional physical control of the ports. You must set up the switch as a physical member of the FICON AD. Device Connection Control (DCC) and Switch Connection Control (SCC) policies are supported only in ADO and AD255, because ACL configurations are supported only in ADO and AD255.
iSCSI	iSCSI operations are supported only in ADO.
LSAN zoning	Refer to <a href="#">“Admin Domains and LSAN zones”</a> on page 363 for details.
Management applications	Management interfaces that access the fabric without a user’s credentials continue to get the physical fabric view. Examples include SNMPv1, Web Tools, HTTP access, unzoned management server query, FAL in-band CT requests from FAL Proxy to FAL Target, and FC-CT-based management applications. Access from applications or hosts using management server calls can be controlled using the management server ACL support provided by the <b>msConfigure</b> command. Note that this is a switch-specific setting and not a fabric-wide setting.
Port swapping and PID formats	Admin Domain port members are specified in <i>domain,index</i> format. Based on the PID format, a <i>domain,index</i> member indicates a slot and port in the switch. The <i>domain,index</i> member is effectively a member of that AD. Port swapping has no effect on AD support as port swapping swaps only the area numbers of two ports and Admin Domains are specified using <i>domain,index</i> members. For detailed information about configuring the PID format, refer to <a href="#">Chapter 3, “Performing Advanced Configuration Tasks”</a> .
RSCN	Admin Domains do not introduce any RSCN changes to devices or hosts.
Virtual Fabrics	Virtual Fabrics and Admin Domains are mutually exclusive and are not supported at the same time on a switch. To use Admin Domains, you must first disable Virtual Fabrics; to use Virtual Fabrics, you must first delete all Admin Domains. If you connect a switch with Admin Domains to a Virtual Fabrics-enabled switch, the link is segmented with the reason “VF AD conflict.”
Zoning	Refer to <a href="#">“Admin Domains, zones, and zone databases”</a> on page 362 for details.

## Admin Domains, zones, and zone databases

Admin Domains introduce two types of zone database nomenclature and behavior:

- Root zone database

If you do not use Admin Domains, there is only one zone database. This legacy zone database is known as the *root zone database*. If you create Admin Domains, several zone databases exist: the root zone database, which is owned by ADO, and other zone databases, one for each user-defined Admin Domain.

AD-level zone information is merged with the root zone configuration and enforced.

- AD zone databases

Each AD (AD1 through AD254) has its own zone database, with the defined and effective zone configurations and all related zone objects (zones, zone aliases, and zone members). Each AD has its own zone transaction buffer. Within an Admin Domain, you can configure zoning only with the devices that are present in that Admin Domain.



The AD zone database also has the following characteristics:

- Each zone database has its own name space. For example, you can define a zone name of test\_z1 in more than one Admin Domain.
- There is no zone database linked to the physical fabric (AD255) and no support for zone database updates. In the physical fabric context (AD255), you can only view the complete hierarchical zone database, which is all of the zone databases in ADO through AD254.
- You can concurrently edit the separate zone databases.
- With AD support, zoning updates are supported selectively at each AD level. For example, a zone change in AD1 results in an update request only for the AD1 zone database.

Zoning operations ignore any resources not in the Admin Domain, even if they are specified in the zone. The behavior functions similarly to specifying offline devices in a zone. All zones from each AD zone configuration are enforced. The enforcement policy encompasses zones in the effective zone configuration of the root zone database and the effective zone configurations of each AD.

---

#### NOTE

You must define the Admin Domain members in the same way that they are defined as zone members. That is, if an object is defined by WWN in a zone, it must be defined by WWN in an Admin Domain. If it is defined by *domain,index* in a zone, it must be defined by *domain,index* in the Admin Domain. If both zoning schemes are used, then objects must be defined in the Admin Domain by both WWN and *domain,index*.

---

Using the **zone --validate** command, you can see all zone members that are not part of the current zone enforcement table but *are* part of the zoning database. A member might not be part of the zone enforcement table for the following reasons:

- The device is offline.
- The device is online but is not part of the current Admin Domain.

Refer to [“Validating a zone”](#) on page 251 for instructions on using the **zone --validate** command.

---

#### NOTE

AD zone databases do not have an enforced size limit. The zone database size is calculated by the upper limit of the AD membership definition and the sum of all the zone databases for each AD.

---

Admin Domains support the default zone mode of No Access only. Before configuring any Admin Domain, you must set the default zone to No Access mode. Admin Domains without effective zone configurations are presented with No Access. Refer to [“Default zoning mode”](#) on page 252 for more information.

If the administrative domain feature is not active (AD1 through AD254 are not configured and no explicit members are added to ADO), ADO supports both All Access and No Access default zone modes.

## Admin Domains and LSAN zones

LSANs under each Admin Domain are collated into a single name space and sent out to FCR phantom domains using the following format:

```
<original_LSAN_name>_AD<AD_num>
```

For example, a zone with name lsan\_for\_linux\_farm in AD5 is internally converted to lsan\_for\_linux\_farm\_AD005.

LSAN zone names in ADO are never converted for backward-compatibility reasons.

The auto-converted LSAN zone names might collide with LSAN zone names in ADO (in the example, if ADO contains `lsan_for_linux_farm_ADO05`, this causes a name collision). Fabric OS does not detect or report such name clashes.

LSAN zone names greater than 57 characters are not converted or sent to the FCR phantom domain. Refer to [Chapter 24, “Using FC-FC Routing to Connect Fabrics,”](#) for information about LSAN zones.

## Configuration upload and download in an AD context

The behavior of the `configUpload` and `configDownload` commands varies depending on the AD context and whether the switch is a member of the current Admin Domain. In the AD context, these commands include only the zone configuration of the current Admin Domain. If the switch is a member of the Admin Domain, all switch configuration parameters are saved and the zone database for that Admin Domain is also saved.

[Table 64](#) lists the sections in the configuration file and the Admin Domain contexts in which you can upload and download these sections. Refer to [Chapter 8, “Maintaining the Switch Configuration File,”](#) for additional information about uploading and downloading configurations.

### NOTE

You cannot use `configDownload` to restore a single Admin Domain. To restore a single Admin Domain, you must first delete all Admin Domains and then issue `configDownload` to restore them.

**TABLE 64** Configuration upload and download scenarios in an AD context

AD contexts	Configuration file sections				
	iSCSI	ACL	Zone	AD headers	Switch configuration and other parameters
AD255: With ADs	Yes	Yes	Yes <sup>1</sup>	Yes	Yes
Without ADs	Yes	Yes	Yes <sup>1</sup>	Yes	Yes
ADO: With ADs and switch membership	Yes	No	Yes <sup>2</sup>	No	Yes
With ADs and without switch membership	Yes	No	Yes <sup>2</sup>	No	No
Without ADs	Yes	Yes	Yes <sup>2</sup>	No	Yes
AD1 – AD254: With switch membership	No	No	Yes <sup>3</sup>	No	Yes
Without switch membership	No	No	Yes <sup>3</sup>	No	No

1. Zone databases for ADO through AD254.
2. Only zone database for ADO.
3. Only zone database for current AD.

The `configDefault` command does not clear zone or Admin Domain database information. This command is allowed only if the switch is a member of the current Admin Domain.

## *Licensed Features*

This section describes optionally licensed Brocade Fabric OS features and includes the following chapters:

- [Chapter 18, “Administering Licensing”](#)
- [Chapter 19, “Inter-chassis Links”](#)
- [Chapter 20, “Monitoring Fabric Performance”](#)
- [Chapter 21, “Optimizing Fabric Behavior”](#)
- [Chapter 22, “Managing Trunking Connections”](#)
- [Chapter 23, “Managing Long Distance Fabrics”](#)
- [Chapter 24, “Using FC-FC Routing to Connect Fabrics”](#)



# Administering Licensing

---

## In this chapter

- Licensing overview . . . . . 367
- Brocade 7800 Upgrade license . . . . . 374
- ICL licensing . . . . . 374
- 8G licensing . . . . . 376
- Slot-based licensing . . . . . 376
- 10G licensing . . . . . 377
- Temporary licenses . . . . . 381
- Viewing installed licenses . . . . . 383
- Activating a license . . . . . 383
- Adding a licensed feature . . . . . 383
- Removing a licensed feature . . . . . 384
- Ports on Demand . . . . . 385

## Licensing overview

Feature licenses are often part of the licensed paperpack supplied with your switch software; if not, they can be purchased separately from your switch vendor, who provides the transaction keys to activate the associated feature or features. Each product, each feature, and each individual switch within a fabric requires its own license key.

Licences may be associated with a feature version. If a feature has a version-based license, that license is valid only for a particular version of the feature. If you want a newer version of the feature, you must purchase a new license. If a license is not version-based, then it is valid for all versions of the feature. Likewise, if you downgrade Fabric OS to an earlier version, some licenses associated with specific features of the version you are downgrading may not work.

---

### NOTE

To preserve licenses and the functioning of features associated with the licenses installed on your switch, use the **configUpload** command before you upgrade or downgrade Fabric OS.

---

Fabric OS includes basic switch and fabric support software, and support for optionally licensed software that is enabled using license keys.

In Fabric OS v7.0.0 or later, some licenses may display with the text “Obsolete license.” This happens because of changes in licensing requirements of some features that no longer require a license key, yet are still installed on a switch.

Table 65 lists the optionally licensed features that are available in Fabric OS 7.0.1:

**TABLE 65 Available Brocade licenses**

License	Description
10 Gigabit FCIP/Fibre Channel (10G license)	<ul style="list-style-type: none"> <li>Allows 10 Gbps operation of FC ports on the Brocade 6510 switch or the FC ports of FC16-32 or FC16-48 port blades installed on a Brocade DCX 8510 Backbone.</li> <li>Enables the two 10-GbE ports on the FX8-24 extension blade when installed on the Brocade DCX, DCX-4S, DCX 8510-4, or DCX 8510-8 Backbone.</li> <li>Allows selection of the following operational modes on the FX8-24 blade: <ul style="list-style-type: none"> <li>10 1-GbE ports and 1 10-GbE port, or</li> <li>2 10-GbE ports</li> </ul> </li> <li>License is slot-based when applied to a Brocade Backbone. It is chassis-based when applied to a Brocade 6510 switch.</li> </ul>
7800 Upgrade	<ul style="list-style-type: none"> <li>Enables full hardware capabilities on the Brocade 7800 base switch, increasing the number of Fibre Channel ports from four to sixteen and the number of GbE ports from two to six.</li> <li>Supports up to eight FCIP tunnels instead of two.</li> <li>Supports advanced capabilities such as tape read/write pipelining.</li> </ul> <p><b>NOTE:</b> The Brocade 7800 switch must have the 7800 Upgrade license to add FICON Management Server (CUP) or Advanced FICON Acceleration licenses.</p>
Adaptive Networking with QoS	<ul style="list-style-type: none"> <li>Enables the QoS SID/DID Prioritization and Ingress Rate Limiting features. These features ensure high priority connections by obtaining the bandwidth necessary for optimum performance, even in congested environments.</li> <li>Available on all 8 Gbps and all 16 Gbps platforms.</li> </ul>
Advanced Extension	<ul style="list-style-type: none"> <li>Enables two advanced extension features: FCIP Trunking and Adaptive Rate Limiting.</li> <li>FCIP Trunking feature allows all of the following: <ul style="list-style-type: none"> <li>Multiple (up to 4) IP source and destination address pairs (defined as FCIP Circuits) using multiple (up to 4) 1-GbE or 10-GbE interfaces to provide a high bandwidth FCIP tunnel and failover resiliency.</li> <li>Support for up to 4 of the following QoS classes: Class-F, high, medium and low priority, each as a TCP connection.</li> </ul> </li> <li>The Adaptive Rate Limiting feature provides a minimum bandwidth guarantee for each tunnel with full usage of available network bandwidth without any negative impact to throughput performance under high traffic load.</li> <li>Available on the Brocade 7800 switch, and the Brocade DCX and DCX-4S and the Brocade DCX 8510 family for the FX8-24 on an individual slot basis.</li> </ul>
Advanced FICON Acceleration	<ul style="list-style-type: none"> <li>Allows use of specialized data management techniques and automated intelligence to accelerate FICON tape read and write and IBM Global Mirror data replication operations over distance, while maintaining the integrity of command and acknowledgement sequences.</li> <li>Available on the Brocade 7800 switch, and the Brocade DCX and DCX-4S and the Brocade DCX 8510 family for the FX8-24 on an individual slot basis.</li> </ul>

**TABLE 65 Available Brocade licenses (Continued)**

License	Description
Brocade Advanced Performance Monitoring	<ul style="list-style-type: none"> <li>Enables performance monitoring of networked storage resources.</li> <li>Includes the Top Talkers feature.</li> </ul>
Brocade Extended Fabrics	<p>Provides greater than 10 km of switched fabric connectivity at full bandwidth over long distances (depending on the platform, this can be up to 3000 km).</p> <p><b>NOTE:</b> This license is not required for long distance connectivity using licensed 10G ports.</p>
Brocade Fabric Watch	<ul style="list-style-type: none"> <li>Monitors mission-critical switch operations.</li> <li>Includes Port Fencing capabilities.</li> </ul>
Brocade ISL Trunking	<ul style="list-style-type: none"> <li>Provides the ability to aggregate multiple physical links into one logical link for enhanced network performance and fault tolerance.</li> <li>Includes Access Gateway ISL Trunking on those products that support Access Gateway deployment.</li> </ul>
Brocade Ports on Demand	<p>Allows you to instantly scale the fabric by provisioning additional ports using license key upgrades.</p> <p><b>NOTE:</b> Applies to the Brocade 300, 5100, 5300, 6505, 6510, and VA-40FC switches.</p>
DataFort Compatibility	<p>Provides ability to read, write, decrypt, and encrypt the NetApp DataFort-encrypted Disk LUNs and Tapes to all of the following:</p> <ul style="list-style-type: none"> <li>Brocade Encryption Switch</li> <li>Brocade enterprise platforms with FS8-18 blade</li> </ul> <p>Includes metadata, encryption and compression algorithms.</p> <p><b>NOTE:</b> Availability is limited. Contact your vendor for details.</p>
Encryption Performance Upgrade	<p>Provides additional encryption bandwidth on encryption platforms. For the Brocade Encryption Switch, two Encryption Performance Upgrade licenses can be installed to enable the full available bandwidth. On a Brocade enterprise platform, a single Performance License can be installed to enable full bandwidth on all FS8-18 blades installed in the chassis.</p>
Enhanced Group Management	<p>Enables full management of the device in a data center fabric with deeper element management functionality and greater management task aggregation throughout the environment. This license is used in conjunction with Brocade Network Advisor application software. This license is applicable to all of the Brocade 8G and 16G FC platforms.</p> <p><b>NOTE:</b> This license is enabled by default on all 16G FC platforms, and on DCX and DCX-4S platforms that are running Fabric OS v7.0.0 or later.</p> <p>This license is not included by default on 8G FC fixed port switches (300, 5100, 5300, VA-40FC, and 8G FC embedded switches).</p>
Enterprise ICL	<p>Allows you to interconnect more than four ICL-attached chassis in the fabric. You can connect up to four Brocade DCX 8510 Backbones via ICLs without this license. If the number of ICL-connected chassis exceeds four, then all of the chassis require the Enterprise ICL license. You must also have an ICL license on each Backbone to activate the ICL ports.</p> <p><b>NOTE:</b> Applies to the Brocade DCX 8510 Backbone family only.</p>

**TABLE 65 Available Brocade licenses (Continued)**

License	Description
FCoE	Included with the Brocade 8000 switch; enables Fibre Channel over Ethernet (FCoE) functions.
FICON Management Server (Also known as Control Unit Port or “CUP”)	Enables host-control of switches in mainframe environments.
High Performance Extension over FCIP/FC (formerly known as “FC-IP Services”)	Includes the IPsec capabilities. Applies to the FR4-18i blade.
ICL 8-Link	Activates all eight links on ICL ports on a Brocade DCX-4S chassis or half of the ICL bandwidth for each ICL port on the Brocade DCX platform by enabling only eight links out of the sixteen links available. This allows you to purchase half the bandwidth of DCX ICL ports initially and upgrade with an additional ICL 8-link license to utilize the full ICL bandwidth at a later time. This license is also useful for environments that want to create ICL connections between a DCX and a DCX-4S; the latter cannot support more than eight links on an ICL port. Available on the Brocade DCX and DCX-4S Backbones only.
ICL 16-Link	Activates all 16 links on ICL ports on a Brocade DCX chassis. Each chassis must have the ICL 16-Link license installed in order to enable the full 16-link ICL connections. Available on the Brocade DCX only.
Inter-Chassis Link (1st POD)	Activates half of the ICL bandwidth on a DCX 8510-8, or all the ICL bandwidth on a DCX 8510-4, allowing you to enable only the bandwidth needed, and upgrade to additional bandwidth at a later time. This license is also useful for environments that wish to create ICL connections between a DCX 8510-8 and a DCX 8510-4; the latter platform supports only half the number of ICL links that the former platform supports. Available on the Brocade DCX 8510-8 and DCX 8510-4 Backbones only.
Inter-Chassis Link (2nd POD)	Activates the remaining ICL bandwidth on the Brocade DCX 8510-8 chassis. Each chassis must have this ICL license installed in order to enable all available ICL connections. Available on the Brocade DCX 8510-8 only.
Integrated Routing	<ul style="list-style-type: none"> <li>Allows any ports in Brocade 5100, 5300, 6510, and VA-40FC switches, the Brocade Encryption Switch, or the Brocade DCX, DCX-4S, and DCX 8510 family platforms to be configured as an EX_Port supporting FC-FC routing.</li> <li>Eliminates the need to add an FR4-18i blade or use the Brocade 7500 for FC-FC routing purposes.</li> </ul>
Server Application Optimization	<ul style="list-style-type: none"> <li>Optimizes application performance for physical servers and virtual machines.</li> <li>Extends virtual channels across server infrastructure.</li> <li>Enables configuration, prioritization, and optimization of application-specific traffic flows.</li> </ul> <p><b>NOTE:</b> This license is not supported on the Brocade 8000. For more information on this license, refer to the <i>Brocade Adapters Administrator's Guide</i>.</p>

Table 66 lists licensed features, each feature’s associated license name, and, if applicable, the location on the local or any connecting switch on which the license must be installed.



**TABLE 66** License requirements and location name by feature

Feature	License	Where license should be installed
Adaptive Rate Limiting	Advanced Extension	Local switch.
Administrative Domains	No license required.	N/A
Bottleneck Detection	No license required.	N/A
Configuration up/download	No license required. <b>NOTE:</b> The <b>configUpload</b> and <b>configDownload</b> commands are provided automatically with Fabric OS on the switch.	N/A
Converged Enhanced Ethernet	Requires FCoE base license and POD1 license. <b>NOTE:</b> These licenses are installed by default and you should not remove them.	Local switch. Brocade 8000 only.
Brocade Network Advisor	No license required for base use.	See also the <i>Brocade Network Advisor User Manual</i> .
Diagnostic tools	No license required.	N/A
Distributed Management Server	No license required.	N/A
Extended Fabrics	Extended Fabrics	Local switch and any attached switches.
Fabric Watch	No license required for baseline monitoring capabilities. Fabric Watch license required for full functionality.	See the <i>Fabric Watch Administrator's Guide</i> .
FCIP	High Performance Extension over FCIP/FC	<b>NOTE:</b> Local and attached switches. License is needed on both sides of tunnel.
FCIP Trunking	Advanced Extension	Local and attached switches.
Fibre Channel Routing/EX_Ports	Integrated Routing	Local switch.
FICON	No license required.	N/A
FICON-CUP	FICON Management Server	Local switch.
FICON Tape Read and Write Emulation over an FCIP Tunnel	<ul style="list-style-type: none"> <li>FICON Tape</li> <li>High Performance Extension over FCIP/FC license or Advanced FICON Acceleration license on Brocade 7800</li> </ul>	Local and attached switches.
FICON XRC Sequence Emulation over an FCIP Tunnel	<ul style="list-style-type: none"> <li>FICON XRC</li> <li>High Performance Extension over FCIP/FC or Advanced FICON Acceleration license on Brocade 7800</li> </ul>	Local and attached switches.
FIPS	No license required.	N/A
Firmware download	No license required. <b>NOTE:</b> The <b>firmwareDownload</b> command is provided automatically with Fabric OS on the switch.	N/A

**TABLE 66 License requirements and location name by feature (Continued)**

Feature	License	Where license should be installed
Full fabric connectivity	Full Fabric <b>NOTE:</b> Also called the Fabric license (visible in <b>licenseShow</b> output) and the E_Port Upgrade license.	Local switch. May be required on attached switches.
In-flight encryption and compression	No license required.	N/A
Inband Management	No license required.	N/A
Ingress rate limiting	Adaptive Networking with QoS	Local switch.
Inter-chassis link (ICL)	<ul style="list-style-type: none"> <li>• ICL 1st POD (Ports on Demand) on the Brocade DCX 8510 Backbone family only.</li> <li>• ICL 2nd POD on the Brocade DCX 8510-8 only.</li> <li>• ICL 8-link on the Brocade DCX and DCX-4S only.</li> <li>• ICL 16-link on the Brocade DCX only.</li> <li>• Enterprise ICL on the Brocade DCX 8510 Backbone family only, for topologies with more than four chassis with ICLs.</li> </ul>	Local and attached platforms.
IPSec	No license required.	N/A
IPsec for FCIP tunnels	High Performance Extension over FCIP/FC	<b>NOTE:</b> Local and attached switches. License is needed on both sides of tunnel.
LDAP	No license required.	N/A
Logical fabric	No license required.	N/A
Logical switch	No license required.	N/A
Long distance	Extended Fabrics	Local and attached switches. <b>NOTE:</b> License is needed on both sides of connection.
NPIV	No license required.	N/A
OpenSSH public key	No license required.	N/A
Performance monitoring	Advanced Performance Monitoring for advanced features. No license required for basic features.	Local switch.
Port fencing	Fabric Watch	Local switch.

**TABLE 66 License requirements and location name by feature (Continued)**

Feature	License	Where license should be installed
Ports	<ul style="list-style-type: none"> <li>Ports on Demand licenses required, applicable to a select set of switches only.</li> <li>7800 Upgrade license for the 7800 switches to use all ports.</li> <li>10 Gigabit FCIP/Fibre Channel license to use 10Gb FC ports on FC16-32 blades, FC16-48 blades, and the Brocade 6510.</li> <li>10 Gigabit FCIP/Fibre Channel license to enable 10Gb Ethernet ports on the FX8-24 extension blades.</li> <li>Brocade 8000 – Must have license installed to enable the 8 FC ports. A maximum of 8 FC ports are allowed.</li> </ul>	Local switch.
QoS	Adaptive Networking with QoS	Local switch and attached switches.
QoS on an HBA	<ul style="list-style-type: none"> <li>Server Application Optimization and</li> <li>Adaptive Networking with QoS</li> </ul>	Local switch
RADIUS	No license required.	N/A
RBAC	No license required.	N/A
Routing traffic	No license required. <b>NOTE:</b> Port-based or exchanged-based routing, static routes, frame-order deliver, and dynamic routes all included.	N/A
Security	No license required. <b>NOTE:</b> DCC, SCC, FCS, IP Filter, and authentication policies all included.	N/A
SNMP	No license required.	N/A
Speed	8 Gbps license needed to support 8 Gbps on the Brocade 300, 5100, 5300, and VA-40FC switches and embedded switches only. <b>NOTE:</b> The 8 Gbps license is installed by default, and you should not remove it.  10 Gigabit FCIP/Fibre Channel license is needed to support 10Gb FC ports on FC16-32 blades, FC16-48 blades, and the Brocade 6510, as well as to support the 10Gb Ethernet ports on FX8-24 blades. (See the Ports feature above for more information.)	Local switch
SSH public key	No license required.	N/A
Top Talkers	Advanced Performance Monitoring	Local switch and attached switches.
Traffic Isolation	No license required.	N/A
Trunking	<ul style="list-style-type: none"> <li>ISL Trunking or</li> <li>ISL Trunking Over Extended FabricS</li> </ul>	Local and attached switches.
Two-to-four domains in a fabric	Value Line (Two/Four)	Local switch. May be required on attached switches.
USB usage	No license required.	N/A

**TABLE 66** License requirements and location name by feature (Continued)

Feature	License	Where license should be installed
Virtual Fabrics	No license required.	N/A
Web Tools	No license required.	Local and any switch you will be managing using Web Tools.
Zoning	No license required.	N/A

## Brocade 7800 Upgrade license

The Brocade 7800 has four Fibre Channel (FC) ports and two GbE ports active by default. The number of physical ports active on the Brocade 7800 is fixed. There is one upgrade license to activate the rest of the FC and GbE ports for a total of 16 FC ports and 6 GbE ports. The 7800 Upgrade license activates FC and GbE ports, and also activates additional features outlined in [Table 67](#).

### NOTE

You must reboot the Brocade 7800 switch after installing the 7800 Upgrade license.

**TABLE 67** Base to Upgrade license comparison

Feature	Base model	7800 Upgrade license
Number of Fibre Channel (FC) ports	4	16
Number of GbE ports	2	8
Number of 10-GbE ports	0	0
Number of FCIP Tunnels	2	8
Tape Pipelining over FCIP Tunnel	No	Yes

## ICL licensing

Brocade ICL links operate between the core blades of the DCX 8510 Backbone family, or between the core blades of the DCX and DCX-4S Backbones. Typically, if both core blades are installed, then they are active on the DCX and DCX-4S (or DCX 8510 family) Backbones.

ICL ports on core blades of a DCX 8510-8 can be used only with an ICL (1st or 2nd) POD license. ICL ports on core blades of a DCX 8510-4 can be used only with an ICL 1st POD licence.

ICL ports on core blades of a DCX can be used only with an ICL 16-link or ICL 8-link license. ICL ports on core blades of a DCX-4S can be used only with an ICL 8-link licence.

After the addition or removal of a license, the license enforcement is performed on the ICL ports only when the **portDisable** and **portEnable** commands are issued on the ports. An ICL license must be installed on the enterprise platforms at either end of the ICL connection.

### ICL 1st POD license

The ICL 1st POD license activates half of the ICL bandwidth on the Brocade DCX 8510-8 platform or all of the ICL bandwidth on the Brocade DCX 8510-4.

On the Brocade DCX 8510-8, this license enables QSFP ports 0–7; QSFP ports 8–15 are disabled. (QSFP ports 0–7 correspond to core blade port numbers 0–31, and QSFP ports 8–15 correspond to core blade port numbers 32–63, as observed in **switchShow** output.)

This license allows you to purchase half the bandwidth of the Brocade DCX 8510-8 ICL ports initially and upgrade with an additional ICL license to use the full ICL bandwidth later. This license is also useful for environments with ICL connections between a Brocade DCX 8510-8 and a DCX 8510-4, as the latter supports half the bandwidth of the DCX 8510-8 on each ICL port.

This license is available on the Brocade DCX 8510-8 and DCX 8510-4 platforms only.

## ICL 2nd POD license

The ICL 2nd POD license provides dedicated high-bandwidth links between two Brocade DCX 8510-8 platforms without consuming valuable front-end ports. Each Brocade DCX 8510-8 platform must have the ICL 2nd POD license installed to enable the full number of ICL connections possible.

This license is available for the Brocade DCX 8510-8 only.

## ICL 8-link license

The ICL 8-link license activates half of the ICL bandwidth for each ICL port on the Brocade DCX platform by enabling only half of the ICL links available. This allows you to purchase half the bandwidth of the Brocade DCX ICL ports initially and upgrade with an additional ICL license to use the full ICL bandwidth later. This license is also useful for environments with ICL connections between a Brocade DCX and a DCX-4S, as the latter cannot support more than eight links on an ICL port.

This license is available on the Brocade DCX-4S and DCX platforms only.

## ICL 16-link license

The ICL 16-link license provides dedicated high-bandwidth links between two Brocade DCX chassis, without consuming valuable front-end ports. Each Brocade DCX chassis must have the ICL 16-link license installed in order to enable the full number of ICL connections possible (16 links in the case of a DCX chassis).

This license is available for the Brocade DCX only.

## Enterprise ICL license

The Enterprise ICL license allows you to connect more than four Brocade DCX 8510 Backbones through ICLs. A fabric with four or fewer DCX 8510 Backbones with ICLs does not require the Enterprise ICL license. However, if you add additional ICL-connected chassis to the fabric, then all ICL-connected chassis require the Enterprise ICL license. Note that you continue to need the ICL 8-link or ICL 16-link license to activate the ICL ports.

This license is available on the Brocade DCX 8510-8 and DCX 8510-4 platforms only.

## 8G licensing

---

**ATTENTION**

This license is installed by default and you should not remove it. Port operation may become disrupted, and ports may be prevented from operating at 8 Gbps when the license is removed.

---

The 8 Gbps license applies to the Brocade 300, 5100, 5300, and VA-40FC switches and the 8 Gbps embedded switches; this license does *not* apply to the Brocade 6505 or 6510.

The following list describes the basic rules of using, adding, or removing 8G licenses:

- Without an 8G license, even if there is an 8 Gbps SFP plugged into a port in an applicable platform, the port would be enabled to run at a maximum speed of 4 Gbps.
- To obtain an 8G license, only the license ID from the switch is required. When you add the 8G license, you must enter either the **portDisable** and **portEnable** commands on each individual port on the switch, or the **switchDisable** and **switchEnable** commands on the switch, to enable 8 Gbps features.
- When you remove the 8G license, the ports that are online and already running at 8 Gbps are not disturbed until the port goes offline or the switch is rebooted. The switch ports return to their pre-licensed state maximum speed of 4 Gbps.

## Slot-based licensing

Slot-based licensing is used on the Brocade DCX and DCX 8510 Backbone families to support the FX8-24 blade, and on the Brocade DCX 8510 Backbone family to support the 16 Gbps FC port blades (FC16-24 and FC16-48). License capacity is equal to the number of slots. These licenses allow you to select the slots that the license will enable up to the capacity purchased and to increase the capacity without disrupting slots that already have licensed features running. Each slot-based license key is for a single feature.

Features utilizing slot-based licenses on the FX8-24 blade include:

- 10GbE
- Advanced Extension
- Advanced FICON Acceleration

All other licensed blade features continue to be exclusively chassis-based licenses.

Features using slot-based licenses on the 16 Gbps FC port blades include 10 Gbps FC port operation.

---

**NOTE**

The 10 GbE feature on the FX8-24 blade and the 10 Gbps FC feature on the 16 Gbps FC blades are both enabled by the same 10 Gigabit FCIP/Fibre Channel license (10G license). This license can also enable the 10 Gbps FC feature on a Brocade 6510 switch as a chassis-based license.

---

Any unassigned slot-based license will be automatically assigned to applicable blades that are detected in the chassis when the license is installed. If you have more applicable blades than available license capacity, then you can manually assign or re-assign the licenses as necessary.

Once a license is assigned to a slot, whether it has been automatically assigned or manually assigned, the assignment will remain until you manually reassign the license to another slot. This design allows for various maintenance operations to occur without having the license move around to other slots.

For a slot-based licensed feature to be active, follow these steps:

1. Install a slot-based license on the platform with sufficient slot count for the number of slots upon which you plan to activate the feature.
2. Configure slots so that the licensed feature is assigned to slots. No more slots can be configured than specified in the license.
3. Configure the application that uses the licensed feature on the blade in the slot. This operation verifies that the previous two steps have been successfully completed.

Once these steps are complete, the feature will work on the blade.

## Upgrade and downgrade considerations

When a slot-based license is present on the switch, firmware downgrade to pre-Fabric OS v6.3.0 is allowed, but the slot-based features that were licensed will not be functional.

On upgrade to Fabric OS v7.0.0 or later, any slot-based license that displayed the 10-GbE operation name in the earlier release displays instead as “10 Gigabit FCIP/Fibre Channel (FTR\_10G) license.”

## Assigning a license to a slot

1. Connect to the switch and log in using an account with admin permissions, or an account with OM permissions in the license class of RBAC commands.
2. Enter the **licenseSlotCfg -add** command to add the license to the appropriate slot.

## Removing a license from a slot

To remove a slot-based license from a blade slot, follow these steps.

1. Connect to the switch and log in using an account with admin permissions, or an account with OM permissions in the license class of RBAC commands.
2. Deconfigure the application that uses the licensed feature on the blade slot.
3. Enter the **licenseSlotCfg -remove** command to remove the license from the slot.

# 10G licensing

The 10 Gbps FCIP/Fibre Channel license (10G license) enables the following features:

- 10 Gbps access on the 16 Gbps FC ports on the Brocade 6510 switch, and the FC16-32 and FC16-48 port blades.
- The two 10-GbE ports on the FX8-24 extension blade. Before the Fabric OS v7.0.0 release, this feature was enabled by the 10-GbE license.

This 10G license is applied as a slot-based license on the FC16-32 and FC16-48 port blades and on the FX8-24 extension blade; generic rules for adding slot-based licenses apply, as described in “Slot-based licensing” on page 376. When this license is applied to the Brocade 6510 switch, it is applied to the whole chassis.

Whether you have a bladed (DCX, DCX-4S, DCX 8510-8, or DCX 8510-4) platform or nonbladed (Brocade 6510) switch, you add the 10G license to the chassis using the **LicenseAdd** command, as for any license.

For the bladed platforms, you can either allow automatic license assignment, or choose the blades you want the licenses assigned to manually, as for any slot-based license. Automatic assignment is done sequentially by slot number, beginning with the lowest numbered slot with an enabled blade that supports this feature (FX8-24, FC16-32, or FC16-48 blade), and that does not already have the license applied. If the automatic license assignment does not match your needs, you can use the **licenseSlotCfg --remove** and **licenseSlotCfg --add** commands to remove the license manually from a slot and assign it to a different slot with an FX8-24, FC16-32, or FC16-48 blade.

The same multiple slot-based 10G license can be applied to a mixture of 16 Gbps blades and FX8-24 blades. For example, if you have a 10G license for two-slot capacity, and you have an FX8-24 blade in one slot and an FC16-48 blade in a second slot, then the same license can activate the 10GE ports on the FX8-24 blade and enable 10 Gbps operation on the 10G FC ports on the FC16-48 blade.

After applying a 10G license to the Brocade 6510 chassis or to a 16 Gbps FC blade, you must also configure the port octet (**portCfgOctetSpeedCombo** command) with the correct port octet speed group and configure each port to operate at 10 Gbps (**portCfgSpeed** command). It is necessary to configure the port octet because only certain combinations of port speeds are allowed within the port octet. No license is required for the octet group. If the speed configuration operation succeeds and a 10G-capable SFP is inserted in the port connector, the port will allow operation at 10 Gbps when the link becomes active at that speed.

---

#### NOTE

10 Gbps FC capability is restricted to the ports in the first port octet group on each blade or chassis to which the license is applied.

---

Before removing a 10 Gbps license from an entire platform (**licenseRemove** command) or from a specific blade (**licenseSlotCfg --remove** command), you must first deconfigure all affected FC ports to no longer operate at 10 Gbps.

---

#### NOTE

An FC port that is operating at 10G FC speed on a 16G FC blade or 16G FC switch does not need an Extended Fabrics license to be used for FC long distance connectivity.

FC ports licensed and configured to operate at 10 Gbps on a Brocade 6510 switch or 16 Gbps FC port blade cannot interoperate with 10 Gbps ports on an FC10-6 port blade or with 10 Gbps FC ports on the Mc-6140 platform. The new FC ports use different protocols and physical connections.

---

## Enabling 10 Gbps operation on an FC port

To enable 10 Gbps operation on an FC port on a Brocade 6510 switch or an FC16-32 or FC16-48 blade, follow these steps.



1. Connect to the switch and log in using an account with admin permissions, or an account with OM permissions for the license and switchportconfiguration classes of RBAC commands.
2. Use the **licenseAdd** command to add the 10G license.
3. Use the **licenseShow** command to verify the license.

*Bladed platforms only:* If the results of the automatic license assignment are not what you intended, use the **licenseSlotCfg** command to reassign the license to the desired blades.

4. Use the **portCfgOctetSpeedCombo** command to set the combination speed for the first port octet to a setting that supports 10 Gbps operations. Valid settings for 10 Gbps operations include:
  - 2—Autonegotiated or fixed port speeds of 10 Gbps, 8 Gbps, 4 Gbps, and 2 Gbps
  - 3—Autonegotiated or fixed port speeds of 16 Gbps and 10 Gbps
5. Use the **portCfgSpeed** command to set the port speed on each port you want to operate at 10 Gbps.

#### Example of assigning a 10G license on an FC port blade and enabling 10 Gbps operation on a port

This example assigns a license to slot 4 on a DCX 8510-8 Backbone and enables 10 Gbps operation on port 2 of the port blade in that slot. In this example, the 10G license was first automatically assigned to slot 1.

```
8510-8switch:admin> licenseadd aTFPNFXGLmABANMGtT4LfSBJSDDLWTYD3EFrr4WGAEMBA
8510-8switch:admin> licenseshow
aTFPNFXGLmABANMGtT4LfSBJSDDLWTYD3EFrr4WGAEMBA
  10 Gigabit FCIP/Fibre Channel (FTR_10G) license
  Capacity 1
  Consumed 1
  Configured Blade Slots 1
8510-8switch:admin> licenseslotcfg -remove FTR_10G 1
8510-8switch:admin> licenseslotcfg -add FTR_10G 4
8510-8switch:admin> licenseshow
aTFPNFXGLmABANMGtT4LfSBJSDDLWTYD3EFrr4WGAEMBA
  10 Gigabit FCIP/Fibre Channel (FTR_10G) license
  Capacity 1
  Consumed 1
  Configured Blade Slots 4
8510-8switch:admin> portcfgoctetspeedcombo 4/2 2
8510-8switch:admin> portcfgspeed 4/2 10
8510-8switch:admin>
```

#### Example of assigning a 10G license on a Brocade 6510 and enabling 10 Gbps operation on a port

This example assigns a license to the Brocade 6510 switch and enables 10 Gbps operation on port 2.

```
6510-switch:admin> licenseadd aTFPNFXGLmABANMGtT4LfSBJSDDLWTYD3EFrr4WGAEMBA
6510-switch:admin> licenseshow
aTFPNFXGLmABANMGtT4LfSBJSDDLWTYD3EFrr4WGAEMBA
  10 Gigabit FCIP/Fibre Channel (FTR_10G) license
  Capacity 1
  Consumed 1
6510-switch:admin> portcfgoctetspeedcombo 2
6510-switch:admin> portcfgspeed 2 10
6510-switch:admin>
```

## Enabling the 10-GbE ports on an FX8-24 blade

To enable the 10-GbE ports on an FX8-24 blade, follow these steps.

1. Connect to the Brocade Backbone and log in using an account with admin permissions, or an account with OM permissions for the license class of RBAC commands.
2. Use the **licenseAdd** command to add the 10G license.
3. Use the **licenseShow** command to check the results of automatic license assignment. If the results are not what you intended, use the **licenseSlotCfg** command to reassign the license to the desired FX8-24 blades.
4. Use the **licenseShow** command to verify the license.
5. Use the **bladeCfgGeMode --set mode** command to configure the GbE port mode for the FX8-24 blade. To enable the 10-GbE ports, set the *mode* parameter to one of the following:
  - **10g**—Enables both 10-GbE ports, disables all ten 1-GbE ports.
  - **dual**—Enables the xge0 port (but not xge1) and also enables all ten 1-GbE ports.

### Example of assigning a 10G license on an FX8-24 extension blade and enabling both 10-GbE ports

This example assigns a license to slot 7 on a DCX 8510-4 Backbone and enables both 10-GbE ports on the FX8-24 blade in that slot. In this example, the license was first automatically assigned to slot 1.

```
8510-4switch:admin> licenseadd aTFPNFXGLmABANMGtT4LfsBJSDDLWTYD3EFrr4WGAEMBA
8510-4switch:admin> licenseshow
aTFPNFXGLmABANMGtT4LfsBJSDDLWTYD3EFrr4WGAEMBA
  10 Gigabit FCIP/Fibre Channel (FTR_10G) license
  Capacity 1
  Consumed 1
  Configured Blade Slots 1
8510-4switch:admin> licenseslotcfg -remove FTR_10G 1
8510-4switch:admin> licenseslotcfg -add FTR_10G 7
8510-4switch:admin> licenseshow
aTFPNFXGLmABANMGtT4LfsBJSDDLWTYD3EFrr4WGAEMBA
  10 Gigabit FCIP/Fibre Channel (FTR_10G) license
  Capacity 1
  Consumed 1
  Configured Blade Slots 7
8510-4switch:admin> bladecfggemode --set 10G -slot 7
8510-4switch:admin> switchshow -slot 7
...
158  7  30  019e00  --  --  Offline  VE
159  7  31  019f00  --  --  Offline  VE
      7  ge0      --  1G  No_Module FCIP  Disabled (10G Mode)
      7  ge1      --  1G  No_Module FCIP  Disabled (10G Mode)
      7  ge2      --  1G  No_Module FCIP  Disabled (10G Mode)
      7  ge3      --  1G  No_Module FCIP  Disabled (10G Mode)
      7  ge4      --  1G  No_Module FCIP  Disabled (10G Mode)
      7  ge5      --  1G  No_Module FCIP  Disabled (10G Mode)
      7  ge6      --  1G  No_Module FCIP  Disabled (10G Mode)
      7  ge7      --  1G  No_Module FCIP  Disabled (10G Mode)
      7  ge8      --  1G  No_Module FCIP  Disabled (10G Mode)
      7  ge9      --  1G  No_Module FCIP  Disabled (10G Mode)
      7  xge0     --  10G No_Module FCIP
      7  xge1     --  10G No_Module FCIP
```

## Temporary licenses

A temporary license applies a “try-before-you-buy” approach to certain features so that you can experience the feature and its capabilities prior to buying the license. Once you have installed the license, you are given a time limit to use the feature.

A temporary license can be either a regular temporary license or a universal temporary license:

- A regular temporary license is available on a per-switch basis.
- A universal temporary license can be installed on a switch, but can be applied to multiple switches.

The following licenses are available as temporary or universal temporary licenses:

- 10 Gigabit FCIP/Fibre Channel license (slot-based)
- Advanced Extension license (slot-based)
- Advanced FICON Acceleration license (slot-based)
- Adaptive Networking with QoS license
- Advanced Performance Monitoring license
- Fabric (E\_Port) license
- Fabric Watch license
- FICON Management Server (CUP) license
- Extended Fabrics license
- High Performance Extension over FCIP/FC license
- Integrated Routing license
- Server Application Optimization license
- ISL Trunking license

### Restrictions on upgrading temporary slot-based licenses

If the capacity of the permanent license is equal to or greater than the capacity of the temporary license and you use the same slot assignments, then replacing the temporary license with a permanent license is non-disruptive. If either condition changes, however, then the process is disruptive.

If the permanent license is for fewer slots than the temporary license, you must do the following.

1. Remove the temporary license. The removal process disables the feature.
2. Install the permanent license on the appropriate slots.

If the permanent license is for different slots than the temporary license, you must do the following.

1. Install the permanent license. The temporary license is automatically replaced on the original slots.
2. Deconfigure the application that uses the licensed feature on the original slots.
3. Remove the license from the original slots using the `licenseSlotCfg -remove` command.
4. Add the license to the new slots using the `licenseSlotCfg -add` command.

## Date change restriction

Once the temporary license is installed, you cannot change the time of the switch until the temporary license is removed. To change the time, you must remove the license, change the date, and then re-install the license on the switch. However, if there is any other mechanism that exists to change the time, such as NTP, then it is not blocked. If you are using NTP to synchronize the time between your network devices, including switches or Backbones, then do not attempt to change the system date and time when a temporary license is installed.

## Configupload and download considerations

The **configDownload** and **configUpload** commands download the legacy, enhanced, consumed capacities, and temporary licenses.

## Expired licenses

Once a temporary license has expired, you can view it through the **licenseShow** command. Expired licenses have an output string of "License has expired". RASlog warning messages are generated every hour for licenses present in the database which have expired or are going to expire in the next five days. An expired license may become unusable after a reboot, failover, firmware download, or a port or switch disable or enable operation.

### *Removing an expired license*



#### **CAUTION**

**The following procedure is disruptive to the switch.**

1. Connect to the switch and log in using an account with admin permissions.
2. Enter the **reboot** command for the expiry to take affect.

## Universal temporary licenses

Universal temporary license keys include a duration period. Once installed on a switch, an expiration date is calculated and the duration is decremented until there is no remaining time, at which point it is expired. Because of this, universal temporary licenses should not be installed on a switch until you are ready to use or test the feature, so as not to unnecessarily consume a portion of the temporary-use duration.

The expiration date is based on the system time at the installation of the license plus the number of days for which the universal temporary license is valid. Universal temporary licenses cannot be removed and reinstalled on the same switch.

Universal temporary licenses are always retained in the license database on the product even though they can be explicitly deleted from any user interface.

## Extending a universal temporary license

Extending a universal temporary license is done by adding a temporary license with an expiry date after the universal temporary license expiry date, or by adding a permanent license. Re-applying an existing universal temporary license is not allowed.

## Universal temporary license shelf life

All universal temporary licenses are encoded with a “shelf life” expiration date. Once this date is reached, the temporary licensed feature can no longer be used on the switch.

## Viewing installed licenses

1. Connect to the switch and log in using an account with admin permissions.
2. Enter the **licenseShow** command.

## Activating a license

The transaction key is case-sensitive; it must be entered exactly as it appears in the paperpack. To lessen the chance of error, copy and paste the transaction key. The quotation marks are optional.

1. Take the appropriate following action based on whether you have a license key:
  - If you have a license key, go to [“Adding a licensed feature”](#).
  - If you do not have a license key and are using a transaction key, launch an Internet browser and go to the Brocade website at <http://www.brocade.com>.

2. Select **Products > Software License Keys**.

The **Software License Keys** instruction page appears.

3. Enter the requested information in the required fields and click **Next**.

A verification screen appears.

4. Verify the information appears correctly.

Click **Submit** if the information displayed is correct. If the information is incorrect, click **Previous**, correct the information, and click **Submit**.

An information screen displays the license keys and you will receive an e-mail with the software license keys and installation instructions.

## Adding a licensed feature

To enable a feature, go to the feature’s appropriate section in this manual. Enabling a feature on a switch may be a separate task from adding the license.

For the Brocade Backbones, licenses are effective on both CP blades, but are valid only when the CP blade is inserted into a Backbone that has an appropriate license ID stored in the WWN card. If a CP is moved from one Backbone to another, the license works in the new Backbone only if the WWN card is the same in the new Backbone. Otherwise, you must transfer licenses from the old platform to the new platform by obtaining new licenses for the previously licensed features using the new license ID.

For example, if you swap one CP blade at a time, or replace a single CP blade, then the existing CP blade (the active CP blade) propagates the licenses to the new CP blade if the WWN card has been moved to the new platform.

If you move a standby CP from one Backbone to another, then the active CP will propagate its configuration (including license keys) onto that standby CP.

1. Connect to the switch and log in using an account with admin permissions.
2. Activate the license using the **licenseAdd** command.
3. Verify the license was added by entering the **licenseShow** command. The licensed features currently installed on the switch are listed. If the feature is not listed, enter the **licenseAdd** command again.

Some features may require additional configuration, or you may need to disable and re-enable the switch to make them operational; see the feature documentation for details.

```
switch:admin> licenseshow
aAYtMJg7tmMZrTZ9JTWBC4SXWLJMY3QfBJYHG:
  Fabric license
  Remote Switch license
  Remote Fabric license
  Extended Fabric license
  Entry Fabric license
  Fabric Watch license
  Performance Monitor license
  Trunking license
  4 Domain Fabric license
  FICON_CUP license
  High-Performance Extension over FCIP/FC license
  Full Ports on Demand license - additional 16 port upgrade license
  2 Domain Fabric license
  Integrated Routing license
  Storage Application Services license
  FICON Tape license
  FICON XRC license
  Adaptive Networking license
  Inter Chassis Link license
  Enhanced Group Management license
  8 Gig FC license
  DataFort Compatibility license
  Server Application Optimization license
```

## Removing a licensed feature

1. Connect to the switch and log in using an account with admin permissions.
2. Enter the **licenseShow** command to display the active licenses.

3. Remove the license key using the **licenseRemove** command.

The license key is case-sensitive and must be entered exactly as given. The quotation marks are optional. After removing a license key, the licensed feature is disabled when the switch is rebooted or when a switch disable and enable is performed.

4. Enter the **licenseShow** command to verify the license is disabled.

```
switch:admin> licenseshow
bQebzbRdScRfc0iK:
  Entry Fabric license
  Fabric Watch license
SybbzQQ9edTzcc0X:
  Fabric license

switch:admin> licenseremove "bQebzbRdScRfc0iK"
removing license key "bQebzbRdScRfc0iK"
```

Entering the **licenseShow** command after the **licenseRemove** command displays the remaining licenses.

```
switch:admin> licenseshow
SybbzQQ9edTzcc0X:
  Fabric license
```

If there are no license keys, **licenseShow** displays “No licenses.”

## Ports on Demand

The Brocade models in the following list can be purchased with the number of licensed ports indicated. As your needs increase, you can activate unlicensed ports up to a particular maximum by purchasing and installing the optional Ports on Demand licensed product:

- Brocade 300—Can be purchased with 8 ports and no E\_Port, 8 ports with full fabric access, or 16 ports with full fabric access. A maximum of 16 ports is allowed; 8-port systems can be upgraded in 4-port increments. An E\_Port license upgrade is also available for purchase.
- Brocade 5100—Can be purchased with 24, 32, or 40 licensed ports. A maximum of 40 ports is allowed.
- Brocade 5300—Can be purchased with 48, 64, or 80 licensed ports. A maximum of 80 ports is allowed.
- Brocade 6505—Can be purchased with 12 or 24 licensed ports. A maximum of 24 ports is allowed.
- Brocade 6510—Can be purchased with 24, 36, or 48 licensed ports. A maximum of 48 ports is allowed.
- Brocade 8000—Must have license installed to enable the 8 FC ports. A maximum of 8 ports is allowed.
- Brocade VA-40FC—Can be purchased with 24, 32, or 40 licensed ports. A maximum of 40 ports is allowed.

---

### ATTENTION

Licenses are not interchangeable between units. For example, if you bought a POD license for a Brocade 300, you cannot use that license on a Brocade 5100 or VA-40FC. The licenses are based on the switch License Identifiers and are not interchangeable.

---

Table 68 shows the ports that are enabled by default and the ports that can be enabled after you install the first and second Ports on Demand licenses for each switch type.

**TABLE 68** List of available ports when implementing PODs

Platform	Available user ports		
	No POD license	POD1 or POD2 present	Both POD licenses present
Brocade 300	0-7	0-15	0-23
Brocade 5100	0-23	0-31	0-39
Brocade 5300	0-47	0-63	0-79
Brocade 5410	0-11	N/A	N/A
Brocade 5424	1-8 and 17-20	POD1: 0, 9-16, and 21-23	0-23
Brocade 5450	1-10 and 19-22	POD1: 0, 11-18, and 23-25	0-25
Brocade 5480	1-8 and 17-20	POD1: 9-12 and 21-22 POD2: 0, 13-16, and 23	0-23
Brocade 6505	0-11	POD 1: 0-23	N/A
Brocade 6510	0-23	0-35	0-47
Brocade 8000	24 GbE	24 GbE and 8 FC	24 GbE and 8 FC
Brocade VA-40FC	0-23	0-31	0-39

Ports on Demand is ready to be unlocked in the switch firmware. Its license key may be part of the licensed paperpack supplied with switch software, or you can purchase the license key separately from your switch vendor. You may need to generate a license key from a transaction key supplied with your purchase. If so, launch an Internet browser and go to the Brocade website at <http://www.brocade.com>. Click **Products > Software Products > Software License Keys** and follow the instructions to generate the key.

Each Ports on Demand license activates the next group of ports in numerical order in either 4-port or 8- or 12-port increments, depending on the model. Before installing a license key, you must insert transceivers in the ports to be activated. Remember to insert the transceivers in the lowest group of inactive port numbers first. For example, if only 16 ports are currently active and you are installing one Ports on Demand license key, make sure to insert the transceivers in ports 16 through 23. If you later install a second license key, insert the transceivers in ports 24 through 31. For details on inserting transceivers, see the switch's hardware reference manual.

## Displaying installed licenses

If a single license is installed that enables all Ports on Demand, the license will display as "Full Ports on Demand license - additional X port upgrade license." If there are other individual Ports on Demand licenses installed, these will also be displayed when listing the licenses for a switch, and you will see either "First Ports on Demand license - additional Y port upgrade license" or "Second Ports on Demand license - additional Z port upgrade license." In cases where there are multiple Ports on Demand licenses, the total additional allowed ports will not exceed the total displayed for the "Full Ports on Demand" license.



1. Connect to the switch and log in using an account with admin permissions.
2. Enter the **licenseshow** command.

```
switch:admin> licenseshow
SdSSc9SyRSTuTTdz:
    First Ports on Demand license - additional 16 port upgrade license
SdSSc9SyRSTeXTdn:
    Second Ports on Demand license - additional 16 port upgrade license
SdSSc9SyRSTuXTd3:
    Full Ports on Demand license - additional 32 port upgrade license
```

---

**ATTENTION**

If you enable or disable an active port, you will disrupt any traffic and potentially lose data flowing on that port.

If the port is connected to another switch, you will segment the switch from the fabric and all traffic flowing between the disabled port and the fabric will be lost.

If you remove a Ports on Demand license, the licensed ports will become disabled after the next platform reboot or the next port deactivation.

---

## Activating Ports on Demand

1. Connect to the switch and log in using an account with admin permissions.
2. Verify the current states of the ports using the **portShow** command.

In the **portShow** output, the Licensed field indicates whether the port is licensed.

3. Install the Brocade Ports on Demand license.

For instructions on how to install a license, see [“Adding a licensed feature”](#) on page 383.

4. Use the **portEnable** command to enable the ports.

Alternatively, you can disable and re-enable the switch to activate ports.

5. Use the **portShow** command to check the newly activated ports.

## Dynamic Ports on Demand

The Brocade 5410, 5424, 5450, 5460, 5470, and 5480 embedded switch modules are for bladed servers. These switches support the Dynamic Ports on Demand (POD) feature. The Dynamic POD feature automatically assigns POD licenses from a pool of available licenses based on the server blade installation.

The Dynamic POD feature detects and assigns ports to a POD license only if the server blade is installed with an HBA present. A server blade that does not have a functioning HBA is treated as an inactive link during initial POD port assignment.

The Dynamic POD feature assigns the ports to the POD license as they come online. Typically, assignments are sequential, starting with the lowest port number. However, variations in the equipment attached to the ports can cause the ports to take different amounts of time to come online. This means that the port assignment order is not guaranteed.

If the switch detects more active links than allowed by the current POD licenses, then some ports will not be assigned a POD license. Ports that do not receive a POD assignment have a state of *No Sync* or *In Sync*; these ports are not allowed to progress to the online state. Ports that cannot be brought online because of insufficient POD licenses have a state of *(No POD License) Disabled*. You can use the **switchShow** command to display the port states.

## Displaying the port license assignments

When you display the available licenses, you can also view the current port assignment of those licenses.

1. Connect to the switch and log in using an account with admin permissions.
2. Enter the **licensePort --show** command.

### Example showing manually assigned POD licenses

```
switch:admin> licenseport --show
 24 ports are available in this switch
  Full POD license is installed
  Dynamic POD method is in use
 24 port assignments are provisioned for use in this switch:
    12 port assignments are provisioned by the base switch license
    12 port assignments are provisioned by a full POD license
 24 ports are assigned to installed licenses:
    12 ports are assigned to the base switch license
    12 ports are assigned to the full POD license
Ports assigned to the base switch license:
 1, 2, 3, 4, 5, 6, 7, 8, 17, 18, 19, 20
Ports assigned to the full POD license:
 0, 9, 10, 11, 12, 13, 14, 15, 16, 21, 22, 23
```

## Enabling Dynamic Ports on Demand

If the switch is in the static POD mode, then activating the Dynamic POD will erase any prior port license assignments the next time the switch is rebooted. The static POD assignments become the initial Dynamic POD assignments. After the Dynamic POD feature is enabled, you can customize the POD license associations.

1. Connect to the switch and log in using an account with admin permissions.
2. Enter the **licensePort --method dynamic** command with the **dynamic** option to change the license assignment method to dynamic.

```
switch:admin> licenseport --method dynamic
The POD method has been changed to dynamic.
Please reboot the switch now for this change to take effect.
```

3. Enter the **reboot** command to restart the switch.

```
switch:admin> reboot
```

4. Enter the **licensePort --show** command to verify the switch started the Dynamic POD feature.

```
switch:admin> licenseport --show
 24 ports are available in this switch
  Full POD license is installed
  Dynamic POD method is in use
 24 port assignments are provisioned for use in this switch:
    12 port assignments are provisioned by the base switch license
```

```

    12 port assignments are provisioned by a full POD license
    8 ports are assigned to installed licenses:
        8 ports are assigned to the base switch license
        0 ports are assigned to the full POD license
Ports assigned to the base switch license:
    1, 2, 5, 6, 8*, 21, 22, 23
Ports assigned to the full POD license:
    None
Ports not assigned to a license:
    0, 3, 4, 7, 9, 10, 11, 12, 13, 14, 15, 16, 17, 18, 19, 20

16 license reservations are still available for use by unassigned ports
1 license assignment is held by an offline port (indicated by *)

```

## Disabling Dynamic Ports on Demand

Disabling the Dynamic POD feature changes the POD method to static and erases any prior port license associations or assignments the next time the switch is rebooted.

1. Connect to the switch and log in using an account with admin permissions.
2. Enter the **licensePort --method static** command with the **static** option to change the license assignment method to static.

```

switch:admin> licenseport --method static
The POD method has been changed to static.
Please reboot the switch now for this change to take effect.

```

3. Enter the **reboot** command to restart the switch.
4. Enter the **licensePort --show** command to verify the switch changed to static POD.

```

switch:admin> licenseport --show
24 ports are available in this switch
Full POD license is installed
Dynamic POD method is in use
24 port assignments are provisioned for use in this switch:
12 port assignments are provisioned by the base switch license
12 port assignments are provisioned by a full POD license
24 ports are assigned to installed licenses:
12 ports are assigned to the base switch license
12 ports are assigned to the full POD license
Ports assigned to the base switch license:
1, 2, 3, 4, 5, 6, 7, 8, 17, 18, 19, 20
Ports assigned to the full POD license:
0, 9, 10, 11, 12, 13, 14, 15, 16, 21, 22, 23

```

## Reserving a port license

You can allocate licenses by reserving and releasing POD assignments to specific ports. Disabled ports are not candidates for automatic license assignment by the Dynamic POD feature. Persistently disable an otherwise viable port to prevent it from coming online, and thereby preserve a license assignment for another port.

Reserving a license for a port assigns a POD license to that port whether the port is online or offline. That license will not be available to other ports that come online before the specified port.

To allocate licenses to a specific port instead of automatically assigning them as the ports come online, reserve a license for the port. The port receives a POD assignment if any are available.

1. Connect to the switch and log in using an account with admin permissions.
2. Enter the **licensePort --show** command to verify there are port reservations available.

```
switch:admin> licenseport --show
24 ports are available in this switch
Full POD license is installed
Dynamic POD method is in use
24 port assignments are provisioned for use in this switch:
12 port assignments are provisioned by the base switch license
12 port assignments are provisioned by a full POD license
10 ports are assigned to installed licenses:
10 ports are assigned to the base switch license
0 ports are assigned to the full POD license
Ports assigned to the base switch license:
1*, 2*, 3*, 4*, 5*, 6*, 8*, 21, 22, 23
Ports assigned to the full POD license:
None
Ports not assigned to a license:
0, 7, 9, 10, 11, 12, 13, 14, 15, 16, 17, 18, 19, 20
```

3. Take the following appropriate action based on whether port reservations are available:

- If a port reservation is available, then issue the **licensePort --reserve** command to reserve a license for the port.

```
switch:admin> licenseport --reserve 0
```

- If all port reservations are assigned, select a port to release its POD license. Follow the instructions in [“Releasing a port from a POD set”](#) to release a port from its POD assignment. Once the port is released, you can reserve it.

## Releasing a port from a POD set

Releasing a port removes it from the POD set; the port appears as unassigned until it comes back online. Persistently disabling the port ensures that the port cannot come back online and be automatically assigned to a POD assignment. Before you can re-assign a license, you must disable the port and release the license.

After a port is assigned to the POD set, the port is licensed until it is manually removed from the POD port set. When a port is released from its POD port set (Base, Single, or Double), it creates a vacancy in that port set.

1. Connect to the switch and log in using an account with admin permissions.
2. Enter the **switchDisable** command to take the switch offline.

```
switch:admin> switchdisable
```

3. Enter the **switchShow** command to verify the switch state is offline.
4. Enter the **licensePort --release** command to remove the port from the POD license.

```
switch:admin> licenseport --release 0
```

5. Enter the **licensePort --show** command to verify the port is no longer assigned to a POD set.

```
switch:admin> licenseport --show
24 ports are available in this switch
Full POD license is installed
Dynamic POD method is in use
24 port assignments are provisioned for use in this switch:
```

```
12 port assignments are provisioned by the base switch license
12 port assignments are provisioned by a full POD license
10 ports are assigned to installed licenses:
10 ports are assigned to the base switch license
0 ports are assigned to the full POD license
Ports assigned to the base switch license:
1*, 2*, 3*, 4*, 5*, 6*, 8*, 21, 22, 23
Ports assigned to the full POD license:
None
Ports not assigned to a license:
0, 7, 9, 10, 11, 12, 13, 14, 15, 16, 17, 18, 19, 20
```

6. Enter the **switchEnable** command to bring the switch back online.
7. Enter the **switchShow** command to verify the switch state is now online.



# Inter-chassis Links

---

## In this chapter

- [Inter-chassis links](#) ..... 393
- [ICLs for the Brocade DCX 8510 Backbone family](#) ..... 394
- [ICLs for the Brocade DCX Backbone family](#) ..... 395
- [Virtual Fabrics considerations for ICLs](#) ..... 396
- [Supported topologies for ICL connections](#) ..... 397

## Inter-chassis links

An inter-chassis link (ICL) is a licensed feature used to interconnect two Brocade Backbones. ICL ports in the core blades are used to interconnect the Backbones, potentially increasing the number of usable ports in the Backbone chassis. The ICL ports are internally managed as E\_Ports.

The Brocade Backbones support two types of ICLs:

- The Brocade DCX 8510 Backbone family supports optical ICL QSFPs.
- The Brocade DCX Backbone family supports proprietary copper ICL connectors.

When two Brocade Backbones are interconnected by ICLs, each chassis requires a unique domain and is managed as a separate switch.

ICL ports can be used only with an ICL license. For more information on how license enforcement occurs, refer to [Chapter 18, “Administering Licensing”](#). After the addition or removal of a license, the license enforcement is performed on the ICL ports only when you issue the **portDisable** and **portEnable** commands on the switch for the ports or the **bladeDisable** and **bladeEnable** commands for the core blade. All ICL ports must be disabled and then re-enabled for the license to take effect. An ICL license must be installed on both platforms forming the ICL connection.

The ICL ports appear as regular ports, with some restrictions. All port parameters associated with ICL ports are static and all **portCfg** commands are blocked from changing any of the ICL port parameters. The only management associated with ICL ports and cables is monitoring the status of the LEDs on the ICL ports and any maintenance if the Attention LED is blinking yellow.

When you connect two Brocade Backbones, the following features are supported:

- Trunking
- Buffer-to-buffer credit sharing
- QoS

---

### NOTE

You cannot interconnect a Brocade DCX Backbone family chassis with a Brocade DCX 8510 Backbone family chassis.

---

Refer to the hardware reference manuals for additional information about LED status and ICL connections, including instructions on how to cable ICLs.

## ICLs for the Brocade DCX 8510 Backbone family

Each ICL connects the core blades of two Brocade DCX 8510 chassis and provides up to 64 Gbps of throughput within a single cable.

You can have up to 32 QSFP ports in a Brocade DCX 8510-8 chassis or 16 QSFP ports in a Brocade DCX 8510-4 chassis, with up to 2 Tbps ICL bandwidth and support for up to 50 meters of universal optical cables.

The Brocade DCX 8510-8 has four port groups on the CR16-8 core blade. The Brocade DCX 8510-4 has two port groups on the CR16-4 core blade. Each port group has four QSFP connectors, and each QSFP connector maps to four user ports. Refer to the hardware reference manuals for details about the port groups.

Following are ICL configuration guidelines for trunking bandwidth and High Availability:

- ICLs must be installed in groups of two. Each pair of ICLs must be in the same port group.
- The recommended minimum number of ICLs between two Brocade DCX 8510 chassis is four. Additional ICLs should be added in increments of two.
- For High Availability, you should have at least two ICLs from each core blade. [Figure 58](#) shows two Brocade DCX 8510-8 chassis connected with full redundancy using four ICL connections.

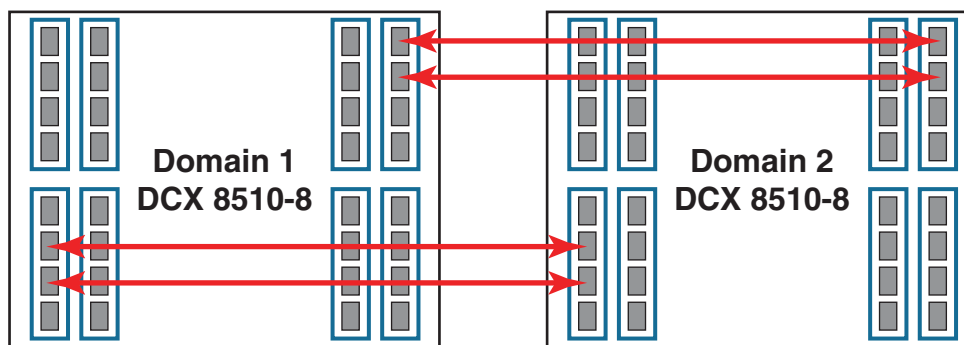

**FIGURE 58** Minimum configuration for 64 Gbps ICLs

- The maximum number of ICLs between two Brocade DCX 8510-4 chassis or between a Brocade DCX 8510-8 and a Brocade DCX 8510-4 is 16.

The maximum number of ICLs between two Brocade DCX 8510-8 chassis is 32.

Because the FSPF routing logic uses only the first 16 paths to come online, only 16 ICLs are utilized. With Virtual Fabrics, however, you can define two logical switches on the chassis and have 16 ICLs in each.

### NOTE

Brocade recommends that you have a maximum of eight ICLs connected to the same neighboring domain, with a maximum of four ICLs from each core blade.

- The ICLs can connect to either core blade in the neighboring chassis. Unlike the copper ICLs, the QSFP ICLs do not need to be cross-connected.



---

**NOTE**

QSFP ICLs and ISLs in the same switch and connected to the same neighboring switch are not supported. This is a topology restriction with 16 Gbps ICLs and any ISLs that are E\_Ports or VE\_Ports.

---

## ICL trunking on the Brocade DCX 8510-8 and DCX 8510-4

ICL trunks automatically form on the ICLs if the ISL Trunking license is installed on each platform.

Each QSFP has four ports, each terminating on a different ASIC. These ports cannot form a trunk with each other, but can form trunks only with corresponding ports on another QSFP.

To establish ICL trunking between platforms in the Brocade DCX 8510 Backbone family, follow these configuration rules:

- The ISL Trunking license must be installed on each platform.
- The QSFP cables must be in the same trunk group, as shown in [Figure 58](#).
- Because QSFP ICLs are installed in pairs, you can have either two or four ports in an ICL trunk.

For example, in [Figure 58](#), each pair of QSFP cables (solid red lines) form four ICL trunks with two ports in each trunk. If you added two more QSFP cables connecting the same two trunk groups, you would still have four ICL trunks, but they would now have four ports in each trunk.

Refer to the hardware reference manuals for information about port numbering and connecting the ICL cables.

## ICLs for the Brocade DCX Backbone family

The Brocade DCX has two ICL connectors at ports ICL0 and ICL1 on each core blade, each aggregating a set of 16 ports. Thus, each core blade provides 32 ICL ports and there are 64 ICL ports available for the entire Brocade DCX chassis. All the ICL connector ports must be connected to the same two Brocade DCX or DCX-4S chassis.

The Brocade DCX-4S has two ICL connector ports at ICL0 and ICL1, each aggregating a set of 8 ports. Thus, each core blade provides 16 ICL ports and there are 32 ICL ports available for the entire Brocade DCX-4S chassis. All the ICL connector ports must be connected to the same two Brocade DCX or DCX-4S chassis.

Only the following cross-ICL group connections are allowed, as illustrated in [Figure 59](#):

- ICL0 ports on the first chassis connect to ICL1 ports on the second chassis.
- ICL1 ports on the first chassis connect to ICL0 ports on the second chassis.

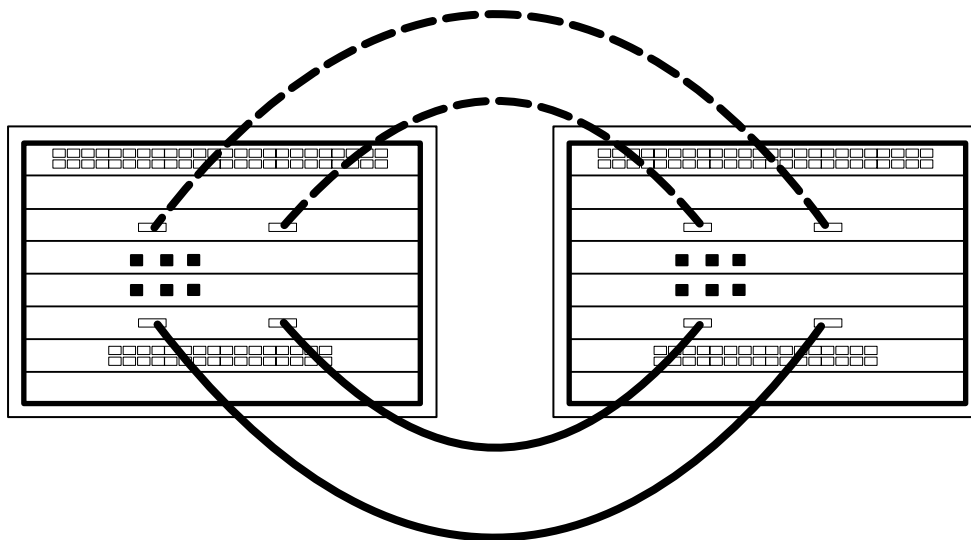

**FIGURE 59 DCX-4S allowed ICL connections**

The following ICL connections are not allowed:

- ICL0 ports to ICL0 ports
- ICL1 ports to ICL1 ports

## ICL trunking on the Brocade DCX and DCX-4S

On the Brocade DCX and DCX-4S, trunks are automatically formed on the ICLs when you install the ISL Trunking license on each platform. The ICLs are managed the same as ISL trunks.

- On the Brocade DCX, each ICL is managed as two 8-port ISL trunks.
- On the Brocade DCX-4S, each ICL is managed as one 8-port ISL trunk.

Follow the guidelines in the hardware reference manuals for connecting the ICL cables.

## Virtual Fabrics considerations for ICLs

In Virtual Fabrics, the ICL ports can be split across the logical switch, base switch, and default switch. The triangular topology requirement must be met for each fabric individually.

The following restrictions apply:

- ICL ports cannot be in a logical switch that is using XISLs. The “Allow XISL Use” attribute for the switch must be off.
- All of the user ports in an ICL cable must be in the same logical switch. Distributing the user ports within the same cable across multiple logical switches is not supported.

## Supported topologies for ICL connections

You can connect the Brocade Backbones in a mesh topology and a core-edge topology. A brief description of each follows.

The illustrations in this section show sample topologies. Refer to the *Brocade SAN Scalability Guidelines* for details about maximum topology configurations.

### Mesh topology

You can connect the Brocade Backbones in a mesh topology, in which every chassis is connected to every other chassis.

A simple form of the mesh topology is the triangular topology (shown in [Figure 60](#)). The triangular topology is supported among three Brocade Backbone chassis. The three chassis must all be from the same family:

- Brocade DCX Backbone family (DCX or DCX-4S)
- Brocade DCX 8510 Backbone family (DCX 8510-8 or DCX 8510-4)

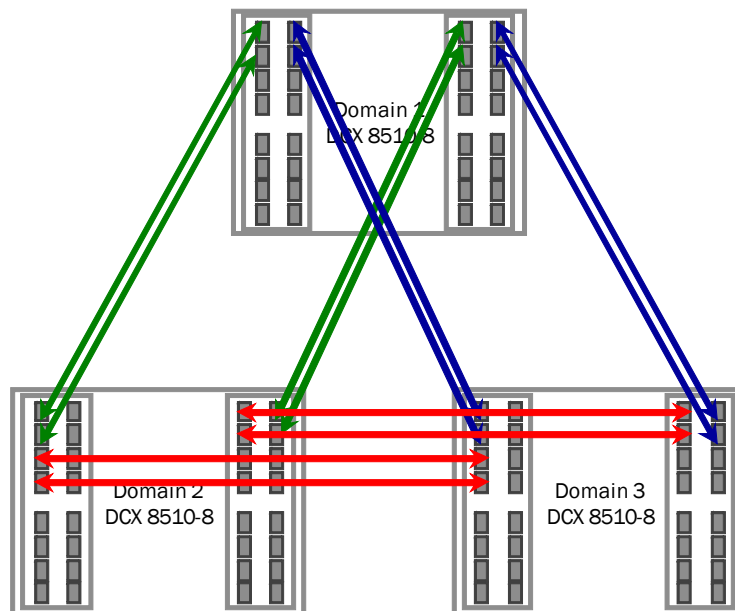

**FIGURE 60** ICL triangular topology with Brocade DCX 8510-8 chassis

During an ICL break in the triangular topology, the chassis that has the connections of the other two is the main chassis. Any error messages relating to a break in the topology appear in the RASlog of the main chassis.

*For the Brocade DCX Backbone family only:* If one ICL is broken but there is a regular ISL, the triangular topology holds given that the ISL cost is lower than the total cost through the ICL linear topology. If a direct ICL link between two chassis is broken, the triangular topology is considered broken when the ISL path between the two switches is a multiple hop. In this case, the triangular topology broken message is posted independently of the cost of the ISL path being lesser or greater than the ICL path between the two switches.

## Core-edge topology

You can also connect the Brocade DCX 8510 Backbones in a core-edge topology. For example, [Figure 61](#) shows six chassis connected in a core-edge topology (four edges and two cores).

Although [Figure 61](#) shows only the Brocade DCX 8510-8, each chassis can be either a Brocade DCX 8510-4 or a DCX 8510-8.

Each line in [Figure 61](#) represents four QSFP cables. The cabling scheme should follow the parallel example shown in [Figure 58](#).

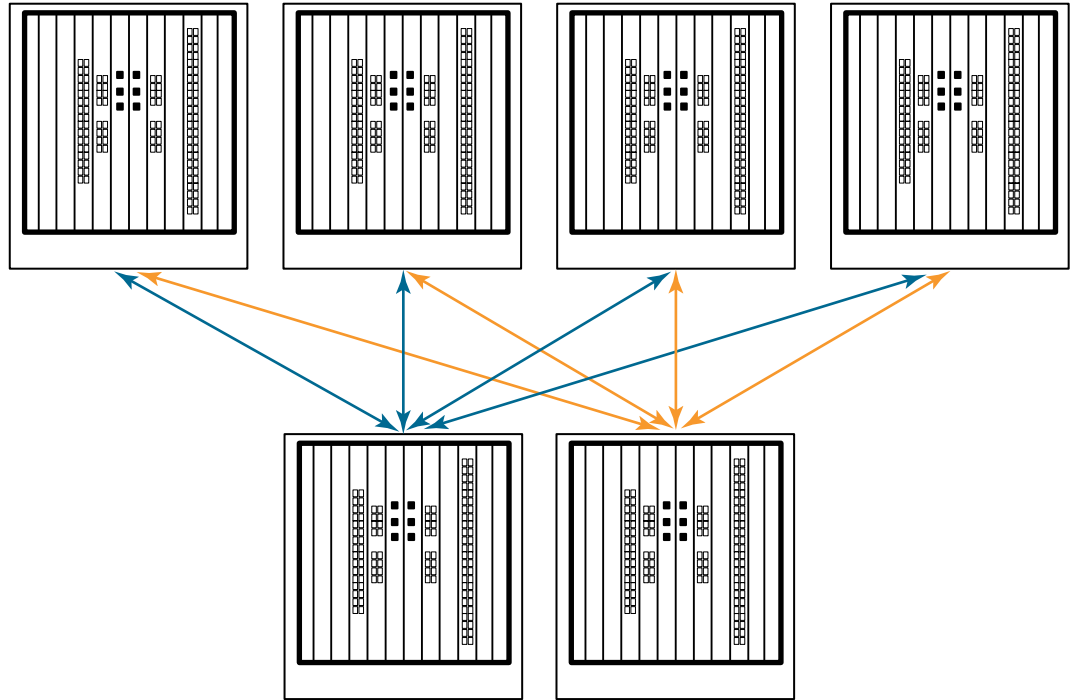

FIGURE 61 64 Gbps ICL core-edge topology

# Monitoring Fabric Performance

---

## In this chapter

- [Advanced Performance Monitoring overview](#) ..... 399
- [End-to-end performance monitoring](#) ..... 401
- [Frame monitoring](#) ..... 406
- [Top Talker monitors](#) ..... 410
- [Trunk monitoring](#) ..... 415
- [Saving and restoring monitor configurations](#) ..... 415
- [Performance data collection](#) ..... 416

## Advanced Performance Monitoring overview

Advanced Performance Monitoring is a licensed feature that provides a comprehensive tool for monitoring the performance of networked storage resources. Additional performance monitoring features, such as CRC error reports, are provided through Web Tools and Brocade Network Advisor. See the *Web Tools Administrator's Guide* and *Brocade Network Advisor User Manual* for information about monitoring performance using a graphical interface.

Advanced Performance Monitor commands are available only to users with admin permissions. Use the **perfhel** command to display a list of commands associated with Advanced Performance Monitoring.

---

### NOTE

The command examples in this chapter use the slot/port syntax required by Backbones. For fixed-port switches, use only the port number where needed in the commands.

---

## Types of monitors

Advanced Performance Monitoring provides the following monitors:

- End-to-End monitors (EE monitors) measure the traffic between a host/target pair.
- Frame monitors measure the traffic transmitted through a port with specific values in the first 64 bytes of the frame.
- Top Talker monitors measure the flows that are major consumers of bandwidth on a switch or port.

## Restrictions for installing monitors

- Advanced Performance Monitoring is not supported on VE\_Ports and EX\_Ports. If you issue commands for any Advanced Performance Monitors on VE\_Ports or EX\_Ports you will receive error messages.
- For the Brocade 8000, performance monitoring is supported only on the FC ports and not on the CEE ports.
- All monitor types are allowed only on physical ports.
- Top Talker and EE monitors on E\_Ports should be installed only in the ingress direction.

## Virtual Fabrics considerations for Advanced Performance Monitoring

In a fabric with Virtual Fabrics enabled, the number of logical switches that can be configured with monitors is restricted. [Table 69](#) lists the platforms that support logical switches and, for each platform, the maximum number of logical switches that can support performance monitors.

**TABLE 69** Number of logical switches that support performance monitors

Platform	Maximum number of logical switches supported	Maximum number of logical switches on which monitors are supported
Brocade DCX Brocade DCX-4S Brocade 8510 family	8	4
Brocade 6510	4	4
Brocade 5100 Brocade VA-40FC	3	3
Brocade 5300	4	3

Each logical switch can have its own set of performance monitors. The installation of monitors is restricted to the ports that are present in the respective logical switch.

- Top Talker and EE monitors are supported on the default logical switch, the base switch, and user-defined logical switches.
- Frame monitors are not supported on logical ISLs (LISLs) in user-defined logical switches.

If a port is moved from one logical switch to another, the behavior of monitors installed on that port is as follows:

- **Frame monitor:** Any frame monitors on the port are deleted. To keep the frame monitor, the monitor must be manually installed on the port after the move.
- **Top Talker (fabric mode):** If fabric mode Top Talkers is enabled on the logical switch, a fabric mode Top Talker monitor is automatically installed on the port after it is moved to the logical switch.
- **Top Talker (port mode):** Any port mode Top Talker monitors on the port are deleted. To keep the port mode Top Talker monitor, the monitor must be manually installed on the port after the move.

## Access Gateway considerations for Advanced Performance Monitoring

EE monitors and frame monitors are supported on switches in Access Gateway mode. Top Talker monitors are not supported on these switches.

EE monitors must be installed on F\_Ports. Frame monitors can be installed on F\_Ports or N\_Ports.

See the *Access Gateway Administrator's Guide* for additional information.

## End-to-end performance monitoring

Use end-to-end (EE) monitoring when you want to monitor throughput between a pair of devices. End-to-end performance monitoring counts the number of words in Fibre Channel frames for a specified Source ID (SID) and Destination ID (DID) pair.

To enable EE performance monitoring, you must configure an EE monitor on a port, specifying the SID-DID pair (in hexadecimal). The monitor counts only those frames with matching SID and DID.

Each SID or DID has the following three fields:

- Domain ID (DD)
- Area ID (AA)
- AL\_PA (PP)

For example, the SID 0x118a0f denotes DD 0x11, AA 0x8a, and AL\_PA 0x0f.

An EE monitor includes these counts:

- RX\_COUNT - words in frames received at the port
 

For frames received at the port with the EE monitor installed, the RX\_COUNT is updated if the frame SID is the same as the SID in the monitor and the frame DID is the same as the DID in the monitor.
- TX\_COUNT - words in frames transmitted from the port
 

For frames transmitted from the port with the EE monitor installed, TX\_COUNT is updated if the frame DID is the same as the SID in the monitor and the frame SID is the same as the DID in the monitor.

## Maximum number of EE monitors

The maximum number of end-to-end monitors supported varies depending on the switch model:

- The Brocade DCX, DCX-4S, DCX 8510, 5100, 6505, 6510, 8000, VA-40FC, and Brocade Encryption Switch models allow up to 1024 end-to-end monitors shared by all ports in the same ASIC.
- The Brocade 300, 5300, 5410, 5424, 5450, 5460, 5470, 5480, and 7800 models allow up to 768 end-to-end monitors shared by all ports in the same ASIC.

The number of interswitch links (ISLs) configured on the switch affects the amount of resources available for end-to-end monitors.

**Virtual Fabrics considerations:** If Virtual Fabrics is enabled, the Brocade DCX, DCX-4S, DCX 8510 and 5300 models allow up to 256 end-to-end monitors on one logical switch. The Brocade 5100, 6510, and VA-40FC allow up to 337 end-to-end monitors on one logical switch.

## Supported port configurations for EE monitors

You can configure EE monitors on F\_Ports and, depending on the switch model, on E\_Ports. The following platforms support EE monitors on E\_Ports:

- Brocade 6505
- Brocade 6510
- Brocade DCX 8510 family

Identical EE monitors cannot be added to the same port. Two EE monitors are considered identical if they have the same SID and DID values after applying the end-to-end mask.

An EE monitor and a port Top Talker monitor cannot co-exist on the same port.

Co-existence of EE monitors and Top Talker monitors on ports belonging to the same ASIC is not recommended because the statistics for the same flow going through ports on the same ASIC might be inaccurate.

## Adding EE monitors

1. Connect to the switch and log in using an account with admin permissions.
2. Enter the following command:

```
perfaddeemonitor [slotnumber/]portnumber sourceID destID
```

When you add an EE monitor to a port, specify the *sourceID* and *destID* in the ingress direction. For example, [Figure 62](#) shows two devices:

- Host A is connected to domain 1 (0x01), switch area ID 18 (0x12), AL\_PA 0x00.
- Dev B is a storage device connected to domain 2 (0x02), switch area ID 30 (0x1e), AL\_PA 0x00.

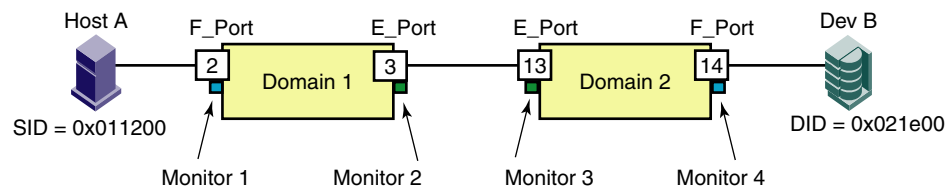

**FIGURE 62** Setting end-to-end monitors on a port

End-to-end performance monitoring looks at traffic on SID/DID pairs in any direction. That is, even if the SID is for a remote device, the traffic is monitored in both directions (the Tx/Rx counters are reversed).

### Example of monitoring the traffic from Host A to Dev B

On Domain 1, add a monitor to the F\_Port, as follows:

```
switch:admin> perfaddeemonitor 2/2 "0x011200" "0x021e00"
```

This monitor (Monitor 1) counts the frames that have an SID of 0x011200 and a DID of 0x021e00. For Monitor 1, RX\_COUNT is the number of words from Host A to Dev B, and TX\_COUNT is the number of words from Dev B to Host A.



**Example of monitoring the traffic from Dev B to Host A**

On Domain 2, add a monitor to the F\_Port as follows:

```
switch:admin> perfaddeemonitor 2/14 "0x021e00" "0x011200"
```

This monitor (Monitor 4) counts the frames that have an SID of 0x021e00 and a DID of 0x011200. For Monitor 4, RX\_COUNT is the number of words from Dev B to Host A, and TX\_COUNT is the number of words from Host A to Dev B.

The E\_Port monitors are configured similar to the F\_Port monitors, but the ingress and egress directions are reversed.

For Monitor 2:

```
switch:admin> perfaddeemonitor 2/3 "0x021e00" "0x011200"
```

For Monitor 3:

```
switch:admin> perfaddeemonitor 2/13 "0x011200" "0x021e00"
```

**Setting a mask for an EE monitor**

End-to-end monitors count the number of words in Fibre Channel frames that match a specific SID/DID pair. If you want to match only part of the SID or DID, you can set a mask on the port to compare only certain parts of the SID or DID. By default, the frame must match the entire SID and DID to trigger the monitor. By setting a mask, you can choose to have the frame match only one or two of the three fields (Domain ID, Area ID, and AL\_PA) to trigger the monitor.

You specify the masks in the form *dd:aa:pp*, where *dd* is the domain ID mask, *aa* is the area ID mask, and *pp* is the AL\_PA mask. The values for *dd*, *aa*, and *pp* are either *ff* (the field must match) or *00* (the field is ignored). The default EE mask value is *ff:ff:ff*.

**NOTE**

Only one mask per port can be set. When you set a mask, all existing end-to-end monitors are deleted.

End-to-end masks are supported only on the Brocade 8000, and Brocade Encryption Switch.

1. Connect to the switch and log in using an account with admin permissions.
2. Enter the **perfSetPortEEMask** command.

```
perfsetporteemask [slotnumber/]portnumber "TxSIDmsk" "TxDIDmsk" "RxSIDmsk"
"RxDIDmsk"
```

The **perfSetPortEEMask** command sets the mask for all end-to-end monitors of a port. If any end-to-end monitors are programmed on a port when the **perfSetPortEEMask** command is issued, then a message displays similar to the following example:

```
switch:admin> perfsetporteemask 1/2, "00:ff:ff"
Changing EE mask for this port will cause ALL EE monitors on this port to be
deleted.
Continue? (yes, y, no, n): [no] y
The EE mask on port 2 is set and EE monitors on this port are deleted
```

The **perfSetPortEEMask** command sets a mask for the Domain ID, Area ID, and AL\_PA of the SIDs and DIDs for frames transmitted from and received by the port.

Figure 63 shows the mask positions in the command. A mask (“ff”) is set on slot 1, port 2 to compare the AL\_PA fields on the SID and DID in all frames (transmitted and received) on port 2. The frame SID and DID must match only the AL\_PA portion of the specified SID-DID pair. Each port can have only one EE mask. The mask is applied to all end-to-end monitors on the port. Individual masks for each monitor on the port cannot be specified.

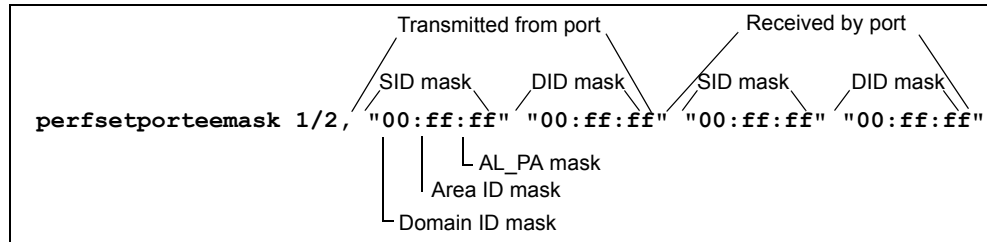

FIGURE 63 Mask positions for end-to-end monitors

## Deleting EE monitors

1. Connect to the switch and log in using an account with admin permissions.
2. Enter the `perfMonitorShow` command to list the valid end-to-end monitor numbers for a port.
3. Enter the `perfDelEEMonitor` command to delete a specific monitor.

If you do not specify which monitor number to delete, you are asked if you want to delete all entries.

### Example

The following example displays the end-to-end monitors on port 0 (the monitor numbers are listed in the KEY column) and deletes monitor number 2 on port 0:

```
switch:admin> perfmonitorshow --class EE 0

There are 4 end-to-end monitor(s) defined on port      0.

KEY      SID      DID      OWNER_APP      TX_COUNT      RX_COUNT      OWNER_IP_ADDR
-----
0  0x000024  0x000016  WEB_TOOLS      0x0000000000000000  0x0000000000000000  10.106.7.179
1  0x000022  0x000033  WEB_TOOLS      0x0000000000000000  0x0000000000000000  10.106.7.179
2  0x000123  0x000789  WEB_TOOLS      0x0000000000000000  0x0000000000000000  10.106.7.179
3  0x001212  0x003434  WEB_TOOLS      0x0000000000000000  0x0000000000000000  10.106.7.179

switch:admin> perfdeleemonitor 0, 2
End-to-End monitor number 2 deleted
```

## Displaying EE monitor counters

You can use this procedure display the end-to-end monitors on a specified port. You can display either the cumulative count of the traffic detected by the monitors or a snapshot of the traffic at specified intervals.

1. Connect to the switch and log in using an account with admin permissions.
2. Enter the `perfmonitorshow` command.

```
perfmonitorshow --class monitor_class [slotnumber/]portnumber [interval]
```

**Example of displaying an end-to-end monitor on a port at 10-second intervals**

```
switch:admin> perfMonitorShow --class EE 4/5 10
Showing EE monitors 4/5 10: Tx/Rx are # of bytes
      0          1          2          3          4
-----
Tx   Rx   Tx   Rx   Tx   Rx   Tx   Rx   Tx   Rx
=====
0    0    0    0    0    0    0    0    0    0
53m  4.9m 53m  4.9m 53m  4.9m 53m  4.9m 53m  0
53m  4.4m 53m  4.4m 53m  4.4m 53m  4.4m 53m  0
53m  4.8m 53m  4.8m 53m  4.8m 53m  4.8m 53m  0
53m  4.6m 53m  4.6m 53m  4.6m 53m  4.6m 53m  0
53m  5.0m 53m  5.0m 53m  5.0m 53m  5.0m 53m  0
53m  4.5m 53m  4.5m 53m  4.5m 53m  4.5m 53m  0
```

**Example of displaying EE monitors on a port**

```
switch:admin> perfMonitorShow --class EE 4/5
There are 7 end-to-end monitor(s) defined on port 53.
KEY      SID      DID      OWNER_APP TX_COUNT      RX_COUNT      OWNER_IP_ADDR
-----
0  0x58e0f  0x1182ef  TELNET    0x0000000000000000  0x0000000000000000  N/A
0  0x21300  0x21dda  TELNET    0x00000004d0ba9915  0x0000000067229e65  N/A
1  0x21300  0x21ddc  TELNET    0x00000004d0baa754  0x0000000067229e65  N/A
2  0x21300  0x21de0  TELNET    0x00000004d0bab3a5  0x0000000067229e87  N/A
3  0x21300  0x21de1  TELNET    0x00000004d0bac1e4  0x0000000067229e87  N/A
4  0x21300  0x21de2  TELNET    0x00000004d0bad086  0x0000000067229e87  N/A
5  0x11000  0x21fd6  WEB_TOOLS 0x00000004d0bade54  0x0000000067229e87  192.168.169.40
6  0x11000  0x21fe0  WEB_TOOLS 0x00000004d0baed41  0x0000000067229e98  192.168.169.40
```

## Clearing EE monitor counters

You can use this procedure to clear statistics counters for end-to-end monitors.

1. Connect to the switch and log in using an account with admin permissions.
2. Enter the **perfmonitorshow** command, to display the monitor numbers on a specific port.

```
perfmonitorshow --class monitor_class [slotnumber/]portnumber
```

3. Enter the **perfmonitorclear** command.

```
perfmonitorclear --class monitor_class [slotnumber/]portnumber [monitorId]
```

The following example clears statistics counters for an end-to-end monitor:

```
switch:admin> perfMonitorClear --class EE 1/2 5
End-to-End monitor number 5 counters are cleared

switch:admin> perfMonitorClear --class EE 1/2
This will clear ALL EE monitors' counters on port 2, continue?
(yes, y, no, n): [no] y
```

## Frame monitoring

Frame monitoring counts the number of times a frame with a particular pattern is transmitted by a port and generates alerts when thresholds are crossed. Frame monitoring is achieved by defining a filter, or frame type, for a particular purpose. The frame type can be a standard type (for example, a SCSI read command filter that counts the number of SCSI read commands that have been transmitted by the port) or a user-defined frame type customized for your particular use. For a complete list of the standard, pre-defined frame types, see the **fmMonitor** command description in the *Fabric OS Command Reference*.

---

### NOTE

The Advanced Performance Monitoring license is required to use the **fmMonitor** command. The monitoring functionality, however, also requires the Fabric Watch license. When you configure actions and alerts through the **fmMonitor** command, Fabric Watch uses these values and generates alerts based on the configuration. If you do not have a Fabric Watch license, these values are ignored. See the *Fabric Watch Administrator's Guide* for more information about using Fabric Watch.

The maximum number of frame monitors and offsets per port depends on the platform. [Table 70](#) shows the maximum number of frame monitors, in any combination of standard and user-defined frame types, and the maximum number of offsets per port.

**TABLE 70** Maximum number of frame monitors and offsets per port

Platform	Max number of frame monitors per port	Max number of offsets per port
Brocade 300, 5300, 5410, 5424, 5450, 5460, 5470, 5480, and 7800	8	8 <sup>1</sup>
Brocade 5100, 6505, 6510, 8000, VA-40FC, DCX, DCX-4S, DCX 8510, and Brocade Encryption Switch	12	20 <sup>2</sup>

1. For switches in Access Gateway mode, the maximum number of offsets per port is 7.
2. For switches in Access Gateway mode, the maximum number of offsets per port is 15.

The actual number of frame monitors that can be configured on a port depends on the complexity of the frame types. For trunked ports, the frame monitor is configured on the trunk master.

**Virtual Fabrics considerations:** Frame monitors are not supported on logical ISLs (LISLs), but are supported on ISLs and extended ISLs (XISLs).

## Creating frame types to be monitored

In addition to the standard frame types, you can create custom frame types to gather statistics that fit your needs. To define a custom frame type, you must specify a series of *offsets*, *bitmasks*, and *values*. For all transmitted frames, the switch performs these tasks:

- Locates the byte found in the frame at the specified *offset*.
- Applies the *bitmask* to the byte found in the frame.
- Compares the new value with the given *value*.
- Increments the filter counter if a match is found.

You can specify up to four values to compare against each offset. If more than one offset is required to properly define a filter, the bytes found at each offset must match one of the given values for the filter to increment its counter. If one or more of the given offsets does not match any of the given values, the counter does not increment. The value of the offset must be between 0 and 63, in decimal format. Byte 0 indicates the first byte of the Start of Frame (SOF), byte 4 is the first byte of the frame header, and byte 28 is the first byte of the payload. Thus only the SOF, frame header, and first 36 bytes of payload can be selected as part of a filter definition. Offset 0 is a special case, which can be used to monitor the first 4 bytes of the frame (SOF). When the offset is set to 0, the values 0–7 that are checked against that offset are predefined as shown in [Table 71](#).

**TABLE 71** Predefined values at offset 0

Value	SOF	Value	SOF
0	SOFf	4	SOFi2
1	SOFc1	5	SOFn2
2	SOFi1	6	SOFi3
3	SOFn1	7	SOFn3

1. Connect to the switch and log in using an account with admin permissions.
2. Enter the **fmMonitor --create** command to create a user-defined frame.

Complete details of the **fmMonitor** command parameters are provided in the *Fabric OS Command Reference*. The **highth** and **action** options set values and actions for Fabric Watch, but do not apply monitoring. To apply the custom values, use the **thconfig --apply** command. See the *Fabric Watch Administrator's Guide* for more information about using this command.

#### Example of creating a user-defined frame type

```
switch:admin> fmmonitor --create MyFrameMonitor -pat
"17,0xFF,0x07;7,0x4F,0x01;" -action email
```

#### Example of creating a user-defined frame type and applying frame monitors to ports 3, 4, and 5

```
switch:admin> fmmonitor --create MyFrameMonitor -pat
"17,0xFF,0x007;7,0x4F,0x01;" -port 3-5
```

## Deleting frame types

Deleting a frame type removes the entire configuration, including configured thresholds and associated actions. It also removes any frame monitors of the specified type from all ports.

You can delete only user-defined frame types; you cannot delete the pre-defined frame types.

1. Connect to the switch and log in using an account with admin permissions.
2. Enter the **fmMonitor --delete** command to delete a specific frame type.

#### Example

```
switch:admin> fmmonitor --delete MyFrameMonitor
```

## Adding frame monitors to a port

If the switch does not have enough resources to add a frame monitor to a port, then other frame monitors on that port might have to be deleted to free resources.

1. Connect to the switch and log in using an account with admin permissions.
2. Enter the **fmMonitor --addmonitor** command to add a frame monitor to one or more ports.  
The set of ports to be monitored is automatically saved to the persistent configuration unless you specify the **-nosave** option on this command.

### Example

This example adds a standard SCSI frame type monitor to ports 3 through 12.

```
switch:admin> fmmonitor --addmonitor SCSI -port 3-12
```

## Removing frame monitors from a port

1. Connect to the switch and log in using an account with admin permissions.
2. Enter the **fmMonitor --delmonitor** command to remove a specific monitor from one or more ports.  
The set of ports to be unmonitored is automatically saved to the persistent configuration unless you specify the **-nosave** option on this command.

### Example

The following example removes the user-defined frame monitor, MyFrameMonitor, from all ports.

```
switch:admin> fmmonitor --delmonitor MyFrameMonitor
```

## Saving frame monitor configuration

When you assign or remove frame monitors on ports, the list of ports to be monitored is automatically saved persistently, unless you specified the **-nosave** option.

1. Connect to the switch and log in using an account with admin permissions.
2. Enter the **fmmonitor --save** command to save the set of ports on which the frame type is monitored to the persistent configuration.

### Example

In this example, the first command adds a standard SCSI frame type monitor to ports 3 through 12, but does not save the port configuration. The second command saves the port configuration persistently.

```
switch:admin> fmmonitor --addmonitor SCSI -port 3-12 -nosave
```

```
switch:admin> fmmonitor --save SCSI
```

## Displaying frame monitors

1. Connect to the switch and log in using an account with admin permissions.
2. Enter the **fmmonitor --show** command.

### Example

This example displays the existing frame types and associated bit patterns on the switch:

```
switch:admin> fmmonitor --show
FRAME_TYPE      BIT PATTERN
-----
scsi             12,0xFF,0x08;
                 scsiread   12,0xFF,0x08;4,0xFF,0x06;40,0xFF,0x08,0x28;
                 scsiwrite  12,0xFF,0x08;4,0xFF,0x06;40,0xFF,0x08,0x28,0x0A,0x2A;
                 scsirw    12,0xFF,0x08;4,0xFF,0x06;40,0xFF,0x08,0x28,0x0A,0x2A;
                 scsi2reserve 12,0xFF,0x08;4,0xFF,0x06;40,0xFF,0x16,0x56;
                 scsi3reserve 12,0xFF,0x08;4,0xFF,0x06;40,0xFF,0x5F;41,0xFF,0x01
                 ip        12,0xFF,0x05;
                 abts     4,0xFF,0x81;40,0xFF,0x81;12,0xFF,0x0;17,0xFF,0x0;
                 baacc    4,0xff,0x84;12,0xff,0x00;17,0xff,00;
```

This example displays configuration details for the pre-defined SCSI frame monitor. Note that in the last entry, the “-” in the Count column indicates that the monitor is configured, but is not installed on the port.

```
switch:admin> fmmonitor --show SCSI

Port|Frame Type |Count          |HIGH Thres|Actions  |TIMEBASE  |CFG
-----
000001|scsi          |0x0000000000000123|1000      |Email   |None      |saved
000002|scsi          |0x0000000000000125|1000      |Email   |None      |saved
000003|scsi          |0x0000000000000143|1000      |Email   |None      |saved
000022|scsi          |-              |0         |None    |None      |saved
```

This example displays values for the pre-defined SCSI frame monitor on port 5, every 5 seconds. Press Enter to halt the display.

```
switch:admin> fmmonitor --show scsi -port 5 -timeinterval 5
Port|Count  |
-----
2011-03-21 00:59:50

000005| 48.3k

2011-03-21 00:59:55

000005| 48.6k

(output truncated)
```

## Clearing frame monitor counters

1. Connect to the switch and log in using an account with admin permissions.
2. Enter the **fmMonitor --clear** command to clear the counters on the ports on which the specified frame type is monitored.

**Example**

This example clears the counters for the ABTS monitor from ports 7 through 10.

```
switch:admin> fmmonitor --clear ABTS -port 7-10
```

## Top Talker monitors

Top Talker monitors determine the flows (SID/DID pairs) that are the major users of bandwidth (after initial stabilization). Top Talker monitors measure bandwidth usage data in real-time and relative to the port on which the monitor is installed.

**NOTE**

*Initial stabilization* is the time taken by a flow to reach the maximum bandwidth. This time varies depending on the number of flows in the fabric and other factors. The incubation period can be up to 14 seconds in the Backbones, and up to 82 seconds in the fixed-port switches.

Applications can use the Top Talker data to do the following:

- Re-route the traffic through different ports that are less busy, so as not to overload a given port.
- Alert you to the top-talking flows on a port if the total traffic on the port exceeds the acceptable bandwidth consumption.

You can use Top Talkers to identify the SID/DID pairs that consume the most bandwidth and can then configure them with certain Quality of Service (QoS) attributes so they get proper priority. See [Chapter 21, “Optimizing Fabric Behavior,”](#) for information on QoS.

The Top Talker monitor is based on SID/DID and not WWNs. Once Top Talker is installed on a switch or port, it remains installed across power cycles.

Top Talkers supports two modes, port mode and fabric mode:

- Port mode Top Talker

A Top Talker monitor can be installed on a port to measure the traffic originating from the port and flowing to different destinations.

You can configure Top Talker monitors on F\_Ports and, depending on the switch model, on E\_Ports. The following platforms support Top Talker monitors on E\_Ports:

- Brocade 6505
- Brocade 6510
- Brocade DCX 8510 family

- Fabric mode Top Talker

In fabric mode, Top Talker monitors are installed on all E\_Ports in the fabric and measure the data rate of all the possible flows in the fabric (ingress E\_Port traffic only). In fabric mode, Top Talker monitors can determine the top *n* bandwidth users on a given switch.

You can install Top Talker monitors either in port mode or fabric mode, but not both.

**NOTE**

A fabric mode Top Talker monitor and an EE monitor cannot be configured on the same fabric. You must delete the EE monitor before you configure the fabric mode Top Talker.



**How do Top Talker monitors differ from EE monitors?** EE monitors provide counter statistics for traffic flowing between a given SID-DID pair. Top Talker monitors identify all possible SID-DID flow combinations that are possible on a given port and provides a sorted output of the top talking flows. Also, if the number of flows exceeds the hardware resources, existing EE monitors fail to get real time data for all of them; however, Top Talker monitors can monitor all flows for a given E\_Port or F\_Port.

**Virtual Fabric considerations:** All logical switches in the same chassis can use either fabric mode Top Talker monitors or port mode Top Talker and EE monitors. You cannot use fabric mode Top Talker monitors and EE monitors together on the same logical switch.

**Admin Domain considerations:** Top Talker monitors are always installed in AD255.

**NPIV considerations:** Top Talker takes NPIV devices into consideration when calculating the top talking flows.

Top Talker monitors are not supported on the embedded platforms: Brocade 5410, 5424, 5450, 5460, 5470, and 5480.

## Top Talker monitors and FC-FC routing

You can enable Top Talker monitors on a platform that is configured to be an FC router. Top Talker monitors and FC routers are concurrently supported on the following platforms:

- Brocade 6505
- Brocade 6510
- Brocade DCX 8510 Backbone family, with the following blades only: FC16-32, FC16-48.

On all other platforms, you can have either Top Talker monitors or FC-FC routing, but not both.

Top Talker monitors are supported on an FC router in both backbone-to-edge and edge-to-edge configurations.

Note the following restrictions:

- An E\_Port-attached switch must be connected and merged with the backbone FC router before you can enable Top Talker on the FC router.
- Fabric mode Top Talker does not support requests for domains (either front port domain or xlate domain).
- Fabric mode Top Talker monitors do not monitor flows over EX\_Ports.

For example, if a host is connected directly to an FC router and the target is on the edge switch (see [Figure 64](#) on page 412), no flows are monitored because none of the flows traverse an E\_Port on the FCR.

In [Figure 65](#) on page 412, however, the flows across the E\_Port on the FC router are monitored.

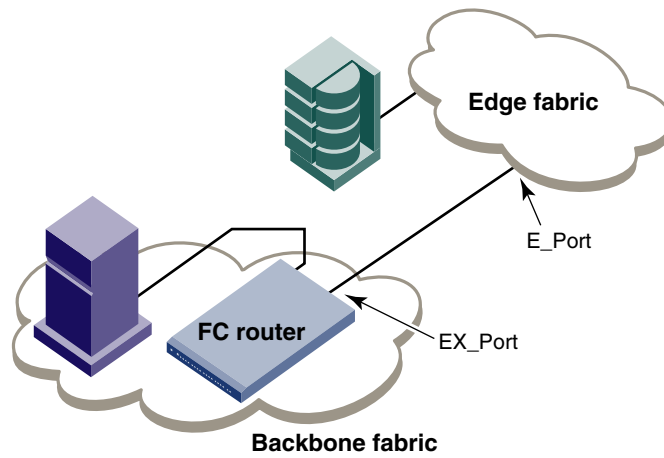

FIGURE 64 Fabric mode Top Talker monitors on FC router do not monitor any flows

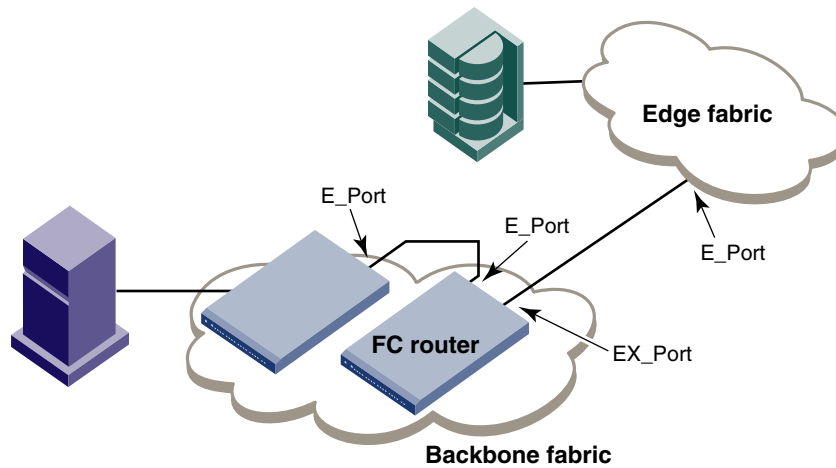

FIGURE 65 Fabric mode Top Talker monitors on FC router monitor flows over the E\_Port

## Limitations of Top Talker monitors

Be aware of the following when using Top Talker monitors:

- Top Talker monitors cannot detect transient surges in traffic through a given flow.
- You cannot install a Top Talker monitor on a mirrored port.
- Top Talker can monitor only 10,000 flows at a time.
- Top Talker is not supported on VE\_Ports, EX\_Ports, and VEX\_Ports.
- The maximum number of all port mode Top Talker monitors on an ASIC is 16. If Virtual Fabrics is enabled, the maximum number of all port mode Top Talker monitors on an ASIC is 8.

## Adding a Top Talker monitor to a port (port mode)

1. Connect to the switch and log in using an account with admin permissions.
2. Enter the **perfttmon --add** command.

```
perfttmon --add [egress | ingress] [slotnumber/]port
```

For example, to monitor the incoming traffic on port 7:

```
perfttmon --add ingress 7
```

To monitor the outgoing traffic on slot 2, port 4 on a Backbone:

```
perfttmon --add egress 2/4
```

## Adding Top Talker monitors on all switches in the fabric (fabric mode)

When fabric mode is enabled, you can no longer install Top Talker monitors on an F\_Port unless you delete fabric mode.

1. Connect to the switch and log in using an account with admin permissions.
2. Remove any EE monitors in the fabric, as described in “[Deleting EE monitors](#)” on page 404. Fabric mode Top Talker monitors and EE monitors cannot both exist in the fabric.
3. Enter the **perfttmon --add fabricmode** command.

```
perfttmon --add fabricmode
```

The system responds:

```
Before enabling fabric mode, please remove all EE monitors in the fabric
continue? (yes, y, no, n):
```

4. Type **y** at the prompt to continue.

Top Talker monitors are added to E\_Ports in the fabric and fabric mode is enabled. Any Top Talker monitors that were already installed on F\_Ports are automatically uninstalled.

If EE monitors are present on the local switch, the command fails with the message:

```
Cannot install Fabric Mode Top Talker because EE monitor is already present
```

If EE monitors are present on remote switches, the command succeeds; however, on the remote switches, fabric mode fails and a raslog message is displayed on those switches.

If a new switch joins the fabric, you must run the **perfttmon --add fabricmode** command on that switch. The Top Talker configuration information is *not* automatically propagated to the new switch.

## Displaying the top *n* bandwidth-using flows on a port (port mode)

1. Connect to the switch and log in using an account with admin permissions.
2. Enter the **perfttmon --show** command.

```
perfttmon --show [slotnumber/]port [n] [wnw | pid]
```

The output is sorted based on the data rate of each flow. If you do not specify the number of flows to display, then the command displays the top 8 flows or the total number of flows, whichever is less.

For example, to display the top 5 flows on port 7 in WWN (default) format:

```
perfttmon --show 7 5
```

To display the top flows on slot 2, port 4 on a Backbone in PID format:

```
perfttmon --show 2/4 pid
```

```
switch:admin> perfttmon --show 2/4 pid
```

```
=====
Src_PID      Dst_PID      MB/sec
=====
0xa90800    0xa05200     6.926
0xa90800    0xa908ef     6.872
```

## Displaying top talking flows for a given domain ID (fabric mode)

1. Connect to the switch and log in using an account with admin permissions.
2. Enter the **perfttmon --show dom** command.

```
perfttmon --show dom domainid [n] [wwn | pid]
```

Fabric mode must be enabled for this option.

The output is sorted based on the data rate of each flow. If you do not specify the number of flows to display, then the command displays the top 8 flows or the total number of flows, whichever is less. The command can display a maximum of 32 flows.

For example, to display the top 5 flows on for domain 1 in WWN (default) format:

```
perfttmon --show dom 1 5
```

To display the top flows on domain 2 in PID format:

```
perfttmon --show dom 2 pid
```

### Example

```
switch:admin> perfttmon --show dom 2 pid
```

```
=====
Src_PID      Dst_PID      MB/sec      Potential E-Ports
=====
0x03f600    0x011300     121.748    2/0,2/2,2/3
0x03f600    0x011300     121.748    3/14,3/15
```

## Deleting a Top Talker monitor on a port (port mode)

1. Connect to the switch and log in using an account with admin permissions.
2. Enter the **perfttmon --delete** command.

```
perfttmon --delete [slotnumber/]port
```

For example, to delete the monitor on port 7:

```
perfttmon --delete 7
```

To delete the monitor on slot 2, port 4 on a Backbone:

```
perfttmon --delete 2/4
```

## Deleting all fabric mode Top Talker monitors

1. Connect to the switch and log in using an account with admin permissions.
2. Enter the `perFTTmon --delete fabricmode` command.

```
perfttmon --delete fabricmode
```

All Top Talker monitors are deleted.

## Trunk monitoring

To monitor E\_Port (ISL) and F\_Port trunks, you can set monitors only on the master port of the trunk. If the master changes, the monitor automatically moves to the new master port.

If a monitor is installed on a port that later becomes a slave port when a trunk comes up, the monitor automatically moves to the master port of the trunk.

Note the following:

- End-to-end monitors are supported for ISLs only on the Brocade 6505, 6510, and DCX 8510 family.
- If an EE monitor is installed on a trunk group and you disable the trunk, the EE monitor will be installed only on the last master port of that trunk group, which might not be the actual port on which the EE monitor was installed when the trunk was enabled.
- For F\_Port trunks, end-to-end masks are allowed only on the F\_Port trunk master. Unlike the monitors, if the master changes, the mask does not automatically move to the new master port.
- All platforms support 12 frame monitors for trunks, except for the Brocade 300, which supports 8 frame monitors for trunks.
- For the Brocade 8000, trunk monitoring is supported only on the FC ports and not on the CEE ports.

## Saving and restoring monitor configurations

To prevent the switch configuration flash from running out of memory, the number of monitors saved to flash memory is limited as follows:

- The total number of EE monitors per port is limited to 16.
- The total number of frame monitors per port is limited to 16.
- The total number of monitors per switch is limited to 512.

When there are more than 512 monitors in the system, monitors are saved to flash memory in the following order:

- The EE monitors for each port (from 0 to MAX\_PORT)
- The frame monitors for each port

EE monitors get preference saving to flash memory when the total number of monitors in a switch exceeds 512. If the total number of monitors per port or switch exceeds the limit, then you will receive an error message indicating the count has been exceeded and that some monitors have been discarded.

1. Connect to the switch and log in using an account with admin permissions.
2. Type one of the following commands, depending on the action you want to perform:
  - To save the current end-to-end and frame monitor configuration settings into nonvolatile memory, use the **perfCfgSave** command:

```
switch:admin> perfCfgsave
This will overwrite previously saved Performance Monitoring
settings in FLASH. Do you want to continue? (yes, y, no, n): [no] y
Please wait ...
Performance monitoring configuration saved in FLASH.
```

- To restore a saved monitor configuration, use the **perfCfgRestore** command. For example, to restore the original performance monitor configuration after making several changes:

```
switch:admin> perfCfgrestore
This will overwrite current Performance Monitoring settings in RAM. Do you
want to continue? (yes, y, no, n): [no] y
Please wait... Performance monitoring configuration restored from FLASH
ROM.
```

- To clear the previously saved performance monitoring configuration settings from nonvolatile memory, use the **perfCfgClear** command:

```
switch:admin> perfCfgclear
This will clear Performance Monitoring settings in FLASH. The RAM settings
won't change. Do you want to continue? (yes, y, no, n): [no] y
Please wait... Committing configuration...done.
Performance Monitoring configuration cleared from FLASH.
```

## Performance data collection

Data collected through Advanced Performance Monitoring is deleted when the switch is rebooted. Using the Brocade Network Advisor Enterprise Edition, you can store performance data persistently. For details on this feature, see the *Brocade Network Advisor User Manual*.

# Optimizing Fabric Behavior

---

## In this chapter

- [Adaptive Networking overview](#) ..... 417
- [Ingress Rate Limiting](#) ..... 418
- [QoS: SID/DID traffic prioritization](#) ..... 419
- [CS\\_CTL-based frame prioritization](#) ..... 420
- [Enabling CS\\_CTL-based frame prioritization](#) ..... 421
- [Disabling CS\\_CTL-based frame prioritization](#) ..... 421
- [QoS zone-based traffic prioritization](#) ..... 421
- [QoS zones](#) ..... 424
- [Setting QoS zone-based traffic prioritization](#) ..... 429
- [Setting QoS zone-based traffic prioritization over FC routers](#) ..... 431
- [Disabling QoS zone-based traffic prioritization](#) ..... 431

## Adaptive Networking overview

Adaptive Networking is a suite of tools and capabilities that enable you to ensure optimized behavior in the SAN. Even under the worst congestion conditions, the Adaptive Networking features can maximize the fabric behavior and provide necessary bandwidth for high-priority, mission-critical applications and connections.

The Adaptive Networking suite includes the following features:

- **Bottleneck detection**

The bottleneck detection feature identifies devices attached to the fabric that are slowing down traffic. Bottleneck detection does not require a license. See [Chapter 13, “Bottleneck Detection,”](#) for information about this feature.
- **Top Talkers**

The Top Talkers feature provides real-time information about the top “n” bandwidth-consuming flows passing through a specific port in the network. Top Talkers requires an Advanced Performance Monitoring license. See [“Top Talker monitors”](#) on page 410 for more information about this feature.
- **Traffic Isolation Zoning**

Traffic Isolation Zoning (TI zoning) allows you to control the flow of interswitch traffic by creating a dedicated path for traffic flowing from a specific set of source ports (F\_Ports). Traffic Isolation Zoning does not require a license. See [Chapter 12, “Traffic Isolation Zoning,”](#) for more information about this feature.

- **Ingress Rate Limiting**  
Ingress rate limiting restricts the speed of traffic from a particular device to the switch port. Ingress rate limiting requires an Adaptive Networking license. See [“Ingress Rate Limiting”](#) on page 418 for more information about this feature.
- **Quality of Service (QoS) SID/DID Traffic Prioritization**  
SID/DID traffic prioritization allows you to categorize the traffic flow between a host and target has having a high or low priority. QoS SID/DID traffic prioritization requires an Adaptive Networking license for 8 Gbps platforms, but does not require a license for 4 Gbps platforms. See [“QoS: SID/DID traffic prioritization”](#) on page 419 for more information about this feature.

You can use the Adaptive Networking features together to optimize the performance of your fabric. For example, you can do the following:

- You can use Top Talkers to identify the SID/DID pairs that consume the most bandwidth and can then configure them with certain QoS attributes so they get proper priority.
- If the bottleneck detection feature detects a latency bottleneck, you can use TI zones or QoS SID/DID traffic prioritization to isolate latency device traffic from high priority application traffic.
- If the bottleneck detection feature detects ISL congestion, you can use ingress rate limiting to slow down low priority application traffic, if it is contributing to the congestion.

## Ingress Rate Limiting

Ingress rate limiting is a licensed feature that requires the Adaptive Networking license. Ingress rate limiting restricts the speed of traffic from a particular device to the switch port. Use ingress rate limiting for the following situations:

- To reduce existing congestion in the network or proactively avoid congestion.
- To enable you to offer flexible bandwidth limit services based on requirements.
- To enable more important devices to use the network bandwidth during specific services, such as network backup.

To limit the traffic, you set the maximum speed at which the traffic can flow through a particular F\_Port or FL\_Port. For example, if you set the rate limit at 4 Gbps, then traffic from a particular device is limited to a maximum of 4 Gbps.

Ingress rate limiting enforcement is needed only if the port can run at a speed higher than the rate limit. For example, if the rate limit is 4 Gbps and the port is only a 2 Gbps port, then ingress rate limiting is not enforced.

The ingress rate limiting configuration is persistent across reboots.

Note the following considerations about ingress rate limiting:

- Ingress rate limiting is applicable only to F\_Ports and FL\_Ports.
- QoS traffic prioritization takes precedence over ingress rate limiting.
- Ingress rate limiting is not enforced on trunked ports.



**Virtual Fabrics considerations:** If Virtual Fabrics is enabled, the rate limit configuration on a port is on a per-logical switch basis. That is, if a port is configured to have a certain rate limit value, and the port is then moved to a different logical switch, it would have no rate limit applied to it in the new logical switch. If that same port is moved back to the original logical switch, it would have the original rate limit take effect again.

## Limiting traffic from a particular device

1. Connect to the switch and log in using an account with admin permissions.
2. Enter the `portCfgQos --setratelimit` command.

```
portcfgqos --setratelimit slot/port ratelimit
```

Example of setting the rate limit on slot 3, port 9 to 4000 Mbps

```
portcfgqos --setratelimit 3/9 4000
```

## Disabling ingress rate limiting

1. Connect to the switch and log in using an account with admin permissions.
2. Enter the `portCfgQos --resetratelimit` command.

```
portcfgqos --resetratelimit slot/port
```

Example of disabling ingress rate limiting on slot 3, port 9

```
portcfgqos --resetratelimit 3/9
```

# QoS: SID/DID traffic prioritization

SID/DID traffic prioritization allows you to categorize the traffic flow between a host and target as having a high, medium, or low priority. Fabric OS supports two types of prioritization:

- Class Specific Control (CS\_CTL)-based frame prioritization
 

Each frame between a host and a target is assigned a specific priority, depending on the value of the CS\_CTL field in the frame header.
- QoS zone-based traffic prioritization
 

All traffic between a host and a target is assigned a specific priority, depending on the name you define for the QoS zone.

CS\_CTL-based prioritization and QoS zone-based prioritization are mutually exclusive. If you enable CS\_CTL-based prioritization on F/FL\_Ports, then QoS zone-based prioritization cannot be used between any devices connected to those F/FL\_Ports.

CS\_CTL-based prioritization takes precedence over QoS zone-based prioritization. If you enable CS\_CTL-based prioritization on F/FL\_Ports that are defined in a QoS zone, CS\_CTL-based prioritization takes precedence over the QoS zones.

[Table 72](#) shows a basic comparison between CS-CTL-based and QoS zone-based prioritization. See [“CS\\_CTL-based frame prioritization”](#) on page 420 and [“QoS zone-based traffic prioritization”](#) on page 421 for detailed information about each type of prioritization scheme.

**TABLE 72 Comparison between CS\_CTL-based and QoS zone-based prioritization**

CS_CTL-based frame prioritization	QoS zone-based traffic prioritization
Requires Adaptive Networking license.	Requires Adaptive Networking license.
Must be manually enabled after you install the license.	Automatically enabled when you install the license.
No zones are required.	Requires you to create QoS zones.
Enabled on F/FL_Ports.	Enabled on E_Ports.
Takes precedence over QoS zone-based prioritization.	Is overridden by CS_CTL-based prioritization.
Priority is defined by CS-CTL field in frame header.	Priority is defined by name of QoS zone.
Prioritization is on a frame-basis.	Prioritization is on a flow-basis.
Setup steps: <ul style="list-style-type: none"> <li>• Enable QoS on F/FL_Ports.</li> </ul>	Setup steps: <ul style="list-style-type: none"> <li>• Create QoS zones with host/target members.</li> <li>• Add the QoS zones to the zone configuration.</li> <li>• Save and then enable the zone configuration.</li> <li>• Enable QoS on E_Ports.</li> </ul>

## License requirements for SID/DID prioritization

Both CS\_CTL-based frame prioritization and QoS zone-based traffic prioritization require the Adaptive Networking license.

An Adaptive Networking license must be installed on every switch that is in the path between a configured device pair.

When you install the Adaptive Networking license, QoS zone-based traffic prioritization is automatically enabled on the E\_Ports, except for long-distance E\_Ports. For long-distance E\_Ports, you must manually enable QoS zone-based traffic prioritization after you install the license.

### ATTENTION

To preserve existing trunk groups, before you install the Adaptive Networking license, manually disable QoS on the 8 Gbps ports. See [“Trunking considerations before you install the Adaptive Networking license”](#) on page 422 for more information.

## CS\_CTL-based frame prioritization

CS\_CTL-based frame prioritization allows you to prioritize the frames between a host and target as having high, medium, or low priority, depending on the value of the CS\_CTL field in the FC frame header.

High, medium, and low priority frames are allocated to different virtual channels (VCs). High priority frames receive more VCs than medium priority frames, which receive more VCs than low priority frames. The virtual channels are allocated according to the CS\_CTL value, as shown in [Table 73](#).

**TABLE 73 Virtual channels assigned to QoS priority for frame prioritization**

CS_CTL value	Priority	Number of VCs	VCs assigned
1 – 8	High priority	4	10, 11, 12, 13
9 – 16	Medium priority	4	2, 3, 4, 5
17 – 24	Low priority	2	8, 9

## Supported configurations for CS\_CTL-based frame prioritization

- CS\_CTL-based frame prioritization is supported on all 8-Gbps and 16-Gbps platforms.
- All switches in the fabric should be running Fabric OS v6.0.0 or later.

---

**NOTE**

If a switch is running a firmware version earlier than Fabric OS v6.0.0, the outgoing frames from that switch lose their priority.

---

## High availability considerations for CS\_CTL-based frame prioritization

If the standby CP is running a Fabric OS version earlier than 6.3.0 and is synchronized with the active CP, then you cannot enable CS\_CTL-based frame prioritization on the active CP. If the standby CP is not synchronized or if no standby CP exists, then enabling CS\_CTL-based frame prioritization succeeds.

## Enabling CS\_CTL-based frame prioritization

When you enable CS\_CTL-based frame prioritization, you should enable it on both the source port and the destination port, so that the frames returned from the destination port for a given exchange always have the same CS\_CTL prioritization as the frames originating from the source port.

1. Connect to the switch and log in to an account that has admin permissions.
2. Enter the **portcfgqos** command.

```
portcfgqos --enable [slot/]port csctl_mode
```

3. Enter **y** at the prompt to override QoS zone-based traffic prioritization.

## Disabling CS\_CTL-based frame prioritization

When you disable CS\_CTL-based frame prioritization, QoS zone-based traffic prioritization is restored, if it had been previously enabled.

1. Connect to the switch and log in to an account that has admin permissions.
2. Enter the **portcfgqos** command.

```
portcfgqos --disable [slot/]port csctl_mode
```

## QoS zone-based traffic prioritization

QoS zone-based traffic prioritization allows you to categorize the traffic flow between a host and target as having a high or low priority. For example, you could assign online transaction processing (OLTP) to high priority and backup traffic to low priority.

All flows without QoS prioritization are considered medium priority.

High, medium, and low priority flows are allocated to different virtual channels (VCs). High priority flows receive more VCs than medium priority flows, which receive more VCs than low priority flows. The virtual channels are allocated as shown in [Table 74](#).

**TABLE 74** Virtual channels assigned to QoS priority for zone-based prioritization

Priority	Number of VCs	VCs assigned
High priority	5	10, 11, 12, 13, 14
Medium priority	4	2, 3, 4, 5
Low priority	2	8, 9

---

**NOTE**

If there is a single low priority flow to a destination ID (DID) and several medium priority flows to that same DID, then it is possible that the medium priority flows would have less bandwidth because they have to share the medium priority VCs, whereas the low priority flow would have a separate VC.

---

## Trunking considerations before you install the Adaptive Networking license

---

**NOTE**

This section applies only to 8 Gbps and 16 Gbps ports that are not long-distance ports.

---

If ports are part of an active trunk group before the Adaptive Networking license is added, ISLs are formed without QoS.

When you install the Adaptive Networking license, QoS is automatically enabled on all ports for which you have not manually disabled QoS, as the ports in the trunk group are set to QoS enabled by default.

Adding the license does not immediately affect the trunk groups, however. The trunks continue to operate without QoS until the next time one of the ISLs is toggled, at which point the toggled ISL comes up with QoS enabled and splits from the trunk group because of a QoS mismatch.

To preserve existing trunk groups, before you install the Adaptive Networking license, manually disable QoS on these ports, as described next.

## Manually disabling QoS on trunked ports

---

**NOTE**

QoS is disabled by default on long-distance 8 Gbps and 16 Gbps ports. The following procedure does not apply to these ports.

---

1. Connect to the switch and log in using an account with admin permissions.
2. Display the ISL information using the following command:

```
islshow
```

- Identify E\_Ports on which QoS should be manually disabled. In the **islshow** output, these ports have all of the following characteristics:
  - 8 Gbps or 16 Gbps ports
  - Trunking is enabled
  - QoS is disabled
- Check whether QoS is enabled on each port identified in [step 3](#) using the following command:

```
portcfgshow
```

In the output, the value of **QOS E\_Port** is **AE** if QoS is automatically enabled by default, **ON** if QoS is enabled manually, and **OFF** or **..** if QoS is disabled.

- Manually disable QoS on all of the ports identified in [step 3](#) for which QoS is enabled (in the **portcfgshow** output, **QOS E\_Port** is **AE** or **ON**).

```
portcfgqos --disable [slot/]port
```

This is a disruptive operation.

### Example

In this example, the **islshow** output displays ports involved in three ISLs:

- Port 2 QoS is already enabled on this ISL, so you should not disable QoS on port 2.
- Ports 19 and 24 QoS is disabled on these ISLs. Check the **portcfgshow** output to determine whether QoS is disabled on these ports.

In the **portcfgshow** output, the value of **QOS\_E\_Port** is **AE** for port 19 and **..** for port 24. This means that QoS is enabled by default on port 19 and disabled on port 24.

You need to disable QoS on port 19.

```
switch:admin> islshow
1: 2->300 10:00:00:05:1e:43:00:00 100 DCX sp: 8.000G bw: 32.000G TRUNK QOS
3: 19-> 10 10:00:00:05:1e:41:43:ac 50 B300 sp: 8.000G bw: 64.000G TRUNK
4: 24-> 12 10:00:00:05:1e:41:42:ad 30 B5300 sp: 8.000G bw: 16.000G TRUNK
```

```
switch:admin> portcfgshow
```

(output truncated)

Ports of Slot	0	16	17	18	19	20	21	22	23	24	25	26	27	28	29	30	31
Speed	AN	AN	AN	AN	AN	AN	AN	AN	AN	AN	AN	AN	AN	AN	AN	AN	AN
Fill Word	0	0	0	0	0	0	0	0	0	0	0	0	0	0	0	0	0
AL_PA Offset 13	..	..	..	..	..	..	..	..	..	..	..	..	..	..	..	..	..
Trunk Port	ON	ON	ON	ON	ON	ON	ON	ON	ON	ON	ON	ON	ON	ON	ON	ON	ON
Long Distance	..	..	..	..	..	..	..	..	..	..	..	..	..	..	..	..	..
VC Link Init	..	..	..	..	..	..	..	..	..	..	..	..	..	..	..	..	..
Locked L_Port	..	..	..	..	..	..	..	..	..	..	..	..	..	..	..	..	..
Locked G_Port	..	..	..	..	..	..	..	..	..	..	..	..	..	..	..	..	..
Disabled E_Port	..	..	..	..	..	..	..	..	..	..	..	..	..	..	..	..	..
Locked E_Port	..	..	..	..	..	..	..	..	..	..	..	..	..	..	..	..	..
ISL R_RDY Mode	..	..	..	..	..	..	..	..	..	..	..	..	..	..	..	..	..
RSCN Suppressed	..	..	..	..	..	..	..	..	..	..	..	..	..	..	..	..	..
Persistent Disable	ON	..	..	..	..	..	..	..	..	..	..	..	..	..	..	..	..
LOS TOV enable	..	..	..	..	..	..	..	..	..	..	..	..	..	..	..	..	..

## 21 QoS zones

NPIV capability	ON	ON	ON	ON	ON	ON	ON	ON	ON	ON	ON	ON	ON	ON	ON	ON
NPIV PP Limit	126	126	126	126	126	126	126	126	126	126	126	126	126	126	126	126
QOS E_Port	AE	AE	AE	AE	AE	AE	AE	AE	..	..	..	..	..	..	..	..
EX Port	..	..	..	..	..	..	..	..	..	..	..	..	..	..	..	..
Mirror Port	ON	..	..	..	ON	..	..	..	..	..	..	..	..	..	..	..
Rate Limit	..	..	..	..	..	..	..	..	..	..	..	..	..	..	..	..
Credit Recovery	ON	ON	ON	ON	ON	ON	ON	ON	ON	ON	ON	ON	ON	ON	ON	ON
Fport Buffers	..	..	..	..	..	..	..	..	..	..	..	..	..	..	..	..
Port Auto Disable	..	..	..	..	..	..	..	..	..	..	..	..	..	..	..	..
CSTL mode	..	..	..	..	..	..	..	..	..	..	..	..	..	..	..	..

where AE:QoSAutoEnable, AN:AutoNegotiate, ..:OFF, NA:NotApplicable, ?:INVALID,

```
switch:admin> portcfgqos --disable 19
```

## QoS zones

You assign high or low priority (QoS level) using a QoS zone. A QoS zone is a special zone that indicates the priority of the traffic flow between a given host/target pair.

The members of a QoS zone are the host/target pairs. QoS zones can contain WWN members (WWNN or WWPN) or *Domain, Index* (D,I) members. If you use D,I notation in your QoS zones, see [“Limitations and restrictions for QoS zone-based traffic prioritization”](#) on page 428 for some considerations you should be aware of.

A QoS zone has a special name to differentiate it from a regular zone. The format of the QoS zone name is as follows:

```
For high priority:   QOSHid_xxxxx
For low priority:    QOSLid_xxxxx
```

where *id* is a flow identifier that designates a specific virtual channel for the traffic flow and *xxxxx* is the user-defined portion of the name. For example, the following are valid QoS zone names:

```
QOSH3_HighPriorityTraffic
QOSL1_LowPriorityZone
```

The switch automatically sets the priority for the “host,target” pairs specified in the zones based on the priority level (H or L) in the zone name.

The flow *id* allows you to have control over the VC assignment and control over balancing the flows throughout the fabric. The *id* is from 1–5 for high priority traffic, which corresponds to VCs 10–14. For low priority traffic, the *id* is from 1–2, which corresponds to VCs 8 and 9. The *id* is optional; if it is not specified, the virtual channels are allocated using a round-robin scheme.

---

### NOTE

If a QoS zone name prefix is specified in an LSAN zone (a zone beginning with prefix "LSAN\_"), the QoS tag is ignored. Only the first prefix in a zone name is recognized. For example, a zone with the name "LSAN\_QOSH\_zone1" is recognized as an LSAN zone and not a QoS zone.

See [“QoS over FC routers”](#) on page 426 for additional considerations when using QoS to prioritize traffic between device pairs in different edge fabrics.

---

For example, [Figure 66](#) shows a fabric with two hosts (H1, H2) and three targets (S1, S2, S3). The traffic prioritization is as follows:

- Traffic between H1 and S1 is high priority.
- Traffic between H1 and S3 and between H2 and S3 is low priority.
- All other traffic is medium priority, which is the default.

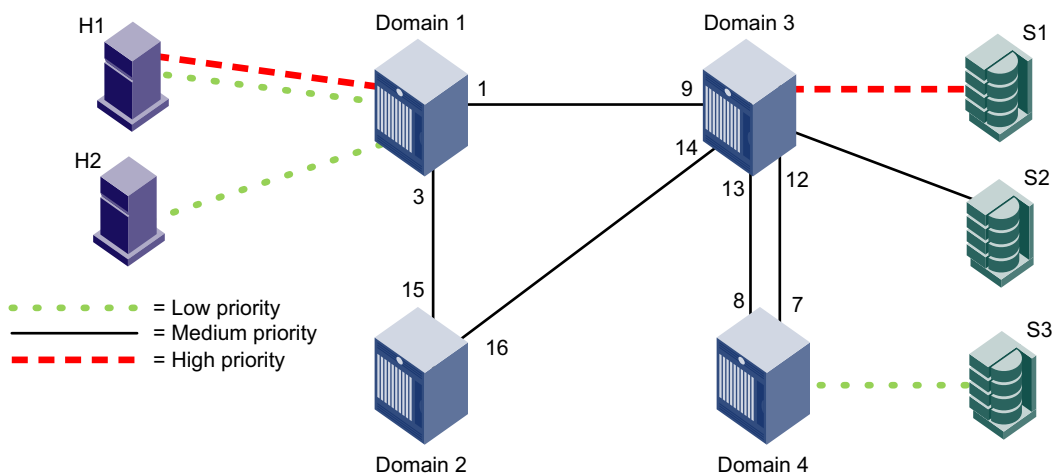

**FIGURE 66** QoS traffic prioritization

For this fabric, you could set up the following QoS zones:

- QOSH\_Zone1      Members: H1, S1
- QOSL\_Zone3      Members: H1, H2, S3

### QoS on E\_Ports

In addition to configuring the hosts and targets in a zone, you must also enable QoS on individual E\_Ports that might carry traffic between the host and target pairs. Path selection between the “host,target” pairs is governed by FSPF rules and is not affected by QoS priorities. For example, in [Figure 67](#), QoS should be enabled on the encircled E\_Ports.

**NOTE**

By default, QoS is enabled on 8 Gbps ports, except for long-distance 8 Gbps ports. QoS is disabled by default on all 4 Gbps ports and long-distance 8 Gbps ports.

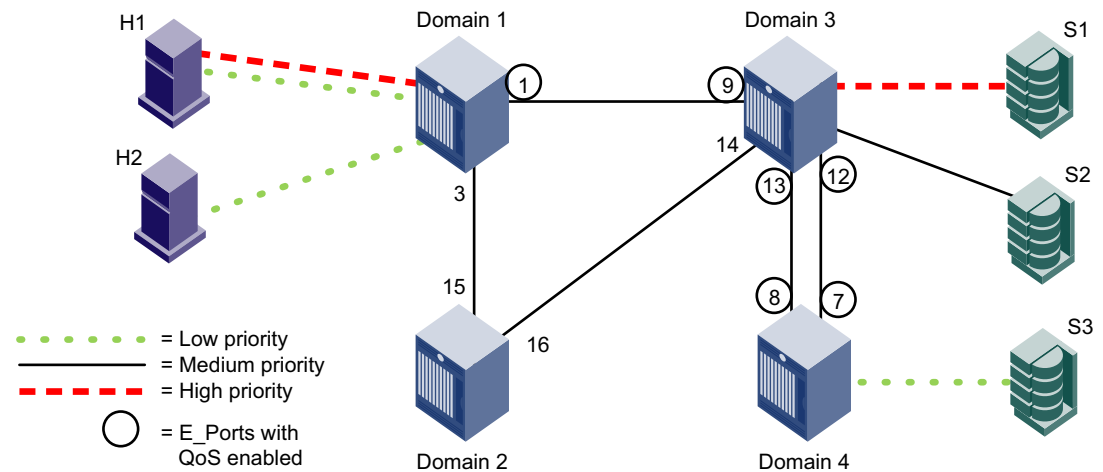

**FIGURE 67** QoS with E\_Ports enabled

You need to enable QoS on the E\_Ports on both ISLs between Domain 3 and Domain 4 because either path might be selected to carry the traffic.

You do *not* need to enable QoS on the E\_Ports on the ISLs between Domain 1 and Domain 2 and between Domain 2 and Domain 3, because these are not the shortest paths between the hosts and the targets. However, if the ISL between Domain 1 and Domain 3 is broken, then the path through Domain 2 would be used.

To guarantee traffic priority, you should enable QoS on all possible E\_Ports. Alternatively, you could use a TI zone to limit the E\_Ports that carry the traffic between a “host,target” pair and enable QoS on only those E\_Ports.

If QoS is not enabled on an E\_Port, the traffic prioritization stops at that point. For example, in [Figure 67](#) if you disabled QoS on E\_Ports “3,12” and “3,13” then the traffic from H1 and H2 to S3 would be low priority from the hosts to Domain 3, but would switch to the default (medium) priority from Domain 3 to the target S3.

## QoS over FC routers

QoS over FCR is QoS traffic prioritization between devices in edge fabrics over an FC router. See [Chapter 24, “Using FC-FC Routing to Connect Fabrics,”](#) for information about FC routers, phantom switches, and the FC-FC Routing Service.

To establish QoS over FC routers, you must do the following:

- Define QoS zones in each edge fabric.
- Define LSAN zones in each edge fabric.
- Enable QoS on the E\_Ports in each edge fabric.
- Enable QoS on the EX\_Ports in the backbone fabric.

See [“Setting QoS zone-based traffic prioritization over FC routers”](#) on page 431 for detailed instructions.

Following are requirements for establishing QoS over FCR:

- QoS over FC routers is supported in Brocade native mode only. It is not supported in interopmode 2 or interopmode 3.



- QoS over FC routers is supported for the following configurations:
  - Edge-to-edge fabric configuration: supported on all platforms.
  - Backbone-to-edge fabric configuration: supported on 16-Gbps-capable platforms only (Brocade 6510 and Brocade DCX 8510 family), and only if the setup contains no other platforms. For all other platforms, you cannot prioritize the flow between a device in an edge fabric and a device in the backbone fabric.
- QoS over FC routers is supported only if Virtual Fabrics is disabled in the backbone fabric. QoS over FC routers cannot be enabled if Virtual Fabrics is also enabled in the backbone fabric.
- The port WWN of the host or target and the port WWN of the proxy device must be in both an LSAN zone and a QoS zone.
- QoS over FC routers is supported on both EX\_Ports and VEX\_Ports. QoS over FC routers is not supported on the FR4-18i blade.
- The EX\_Ports (or VEX\_Ports) in the path between the QoS devices must be on switches running Fabric OS v6.3.0 or later.
- QoS zones must use WWN notation only; D,I notation is not supported for QoS over FCR.
- An Adaptive Networking license must be installed on every switch that is in the path between a given configured device pair, including the switches in the backbone fabric and both edge fabrics.

### Virtual Fabrics considerations for QoS zone-based traffic prioritization

You can prioritize flows between devices in a logical fabric. The priority is retained for traffic going across ISLs and through the base fabric XISLs.

For example, [Figure 68](#) shows a logical fabric that includes H1 and S1. To set the traffic between H1 and S1 to high priority, create a QoS zone in the logical fabric with H1 and S1 as members. Then enable QoS on all of the E\_Ports shown circled in the figure, including all of the E\_Ports in the XISLs (ports 10, 11, 12, 13, 14, 15, 16, and 17).

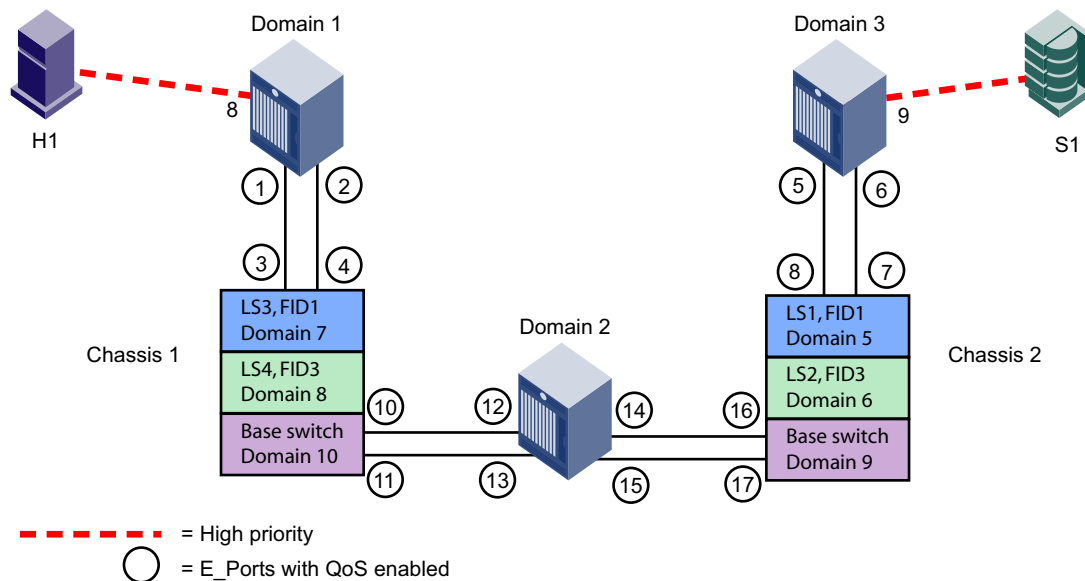

**FIGURE 68** Traffic prioritization in a logical fabric

## High availability considerations for QoS zone-based traffic prioritization

If the standby CP is running a Fabric OS version earlier than 6.3.0 and is synchronized with the active CP, then QoS zones using D,I notation cannot be created. If the standby CP is not synchronized or if no standby CP exists, then the QoS zone creation succeeds.

If QoS zones using D,I notation exist in either the defined or active configuration and the standby CP tries to synchronize with the active CP, the synchronization fails if the standby CP is running a Fabric OS version earlier than 6.3.0. Synchronization can succeed only if the QoS D,I zones are removed.

## Supported configurations for QoS zone-based traffic prioritization

Note the following configuration rules for traffic prioritization:

- All switches in the fabric must be running Fabric OS v6.0.0 or later.

---

### ATTENTION

If QoS traffic crosses an ISL for a switch running a firmware version earlier than Fabric OS v6.0.0, the frames are dropped.

---

- By default, all devices are assigned medium priority.
  - To be assigned high or low priority, hosts and targets must be connected to a Brocade 8-Gbps or 16-Gbps switch or port blade.
  - To preserve the priority level across ISLs, the switches must be running Fabric OS v6.0.0 or later and must be one of the following platforms: Brocade 300, 4100, 4900, 5000, 5100, 5300, 5410, 5424, 5450, 5480, 6510, 7500, 7500E, 7600, 7800, 8000, VA-40FC, 48000, Brocade DCX, DCX-4S, or DCX 8510 family.
- QoS is enabled by default on 8-Gbps and 16-Gbps ports. QoS is disabled by default on all 4-Gbps ports and long-distance ports.

## Limitations and restrictions for QoS zone-based traffic prioritization

- Enabling and disabling QoS is potentially disruptive to the I/O on the affected port.
- If a host and target are included in two or more QoS zones with different priorities, the zone with the lowest priority takes precedence. For example, if an effective zone configuration has QOSH\_z1 (H,T) and QOSL\_z2 (H,T), the traffic flow between H and T will be of low QoS priority.
 

Additionally, if QOSH\_z1 (H,T) overlaps with a “domain,port” zone at the H port, the traffic flow between H and T is dropped to medium priority and the H port is marked as a session-based zoning port.
- Traffic prioritization is enforced on the egress ports only, not on the ingress ports.
- Traffic prioritization is not supported on 10 Gbps ISLs.
- Traffic prioritization is not supported on mirrored ports.
- Traffic prioritization is not supported over LSAN zones. The traffic is always medium priority in the ingress edge fabric, the backbone fabric, and the egress edge fabric.
- Traffic prioritization is not supported on a CryptoTarget container (redirection zone). See the *Fabric OS Encryption Administrator's Guide* for information about redirection zones.

- Traffic prioritization is not supported in McDATA Fabric Mode (interopmode 2) or Open Fabric Mode (interopmode 3).
- You must be running Fabric OS v6.3.0 or later to create QoS zones using D,I notation.
- QoS zones using D,I notation are not supported for QoS over FCR.
- QoS zones using D,I notation should not be used for loop or NPIV ports.
- If QoS is enabled, an additional 16 buffer credits are allocated per port for 8-Gbps ports in LE mode. See [Chapter 23, “Managing Long Distance Fabrics,”](#) for information about buffer credit allocation in extended fabrics.
- **Trunking considerations:** If some ports in a trunk group have QoS enabled and some ports have QoS disabled, then two different trunks are formed, one with QoS enabled and one with QoS disabled.

## Setting QoS zone-based traffic prioritization

1. Connect to the switch and log in using an account with admin permissions.
2. Enter the **zoneCreate** command to create zones for high and low priority traffic.
  - For high priority traffic, use the following syntax:  

```
zonecreate "QOSHid_zonename", "member[; member...]"
```
  - For low priority traffic, use the following syntax:  

```
zonecreate "QOSLid_zonename", "member[; member...]"
```

The *id* is from 1–5 for high priority traffic, which corresponds to VCs 10–14. For low priority traffic, the *id* is from 1–2, which corresponds to VCs 8 and 9. The *id* is optional; if it is not specified, the virtual channels are allocated using a round-robin scheme.
3. Enter the **cfgAdd** command to add the QoS zone to the zone configuration, using the following syntax:  

```
cfgadd "cfgname", "QOSzonename"
```
4. Enter the **cfgSave** command to save the change to the defined configuration.
5. Enter the **cfgEnable** command for the appropriate zone configuration to make the change effective.  

```
cfgenable "cfgname"
```
6. Enter the **portCfgQos** command to enable QoS on the E\_Ports, using the following syntax:  

```
portcfgqos --enable [slot/]port
```

The **portCfgQos** command does not affect QoS prioritization. It only enables or disables the link to pass QoS priority traffic.

**NOTE**

QoS is enabled by default on all ports (except long-distance ports). If you use the **portCfgQos** command to enable QoS on a specific port, the port is toggled to apply this configuration, even though the port already has QoS enabled. The port is toggled because the user configuration changed, even though the actual configuration of the port did not change.

If you later use the **portCfgQos** command to enable QoS on the port again, the port is *not* toggled because the configuration did not change.

**Example**

```
sw0:admin> zonecreate "QOSH1_zone", "10:00:00:00:10:00:00:00;
10:00:00:00:20:00:00:00"
sw0:admin> zonecreate "QOSL2_zone", "10:00:00:00:30:00:00:00;
10:00:00:00:40:00:00:00"
sw0:admin> zoneshow
sw0:admin> cfgadd "cfg1", "QOSH1_zone"
sw0:admin> cfgadd "cfg1", "QOSL2_zone"
sw0:admin> cfgshow
Defined configuration:
  cfg:  cfg1    zone1; QOSH1_zone; QOSL2_zone
  zone:  QOSH1_zone
          10:00:00:00:10:00:00:00; 10:00:00:00:20:00:00:00
  zone:  QOSL2_zone
          10:00:00:00:30:00:00:00; 10:00:00:00:40:00:00:00
  zone:  zone1  10:00:00:00:10:00:00:00; 10:00:00:00:20:00:00:00;
          10:00:00:00:30:00:00:00; 10:00:00:00:40:00:00:00

Effective configuration:
No Effective configuration: (No Access)

sw0:admin> cfgsave
You are about to save the Defined zoning configuration. This
action will only save the changes on Defined configuration.
Any changes made on the Effective configuration will not
take effect until it is re-enabled. Until the Effective
configuration is re-enabled, merging new switches into the
fabric is not recommended and may cause unpredictable
results with the potential of mismatched Effective Zoning
configurations.
Do you want to save Defined zoning configuration only? (yes, y, no, n): [no] y
Updating flash ...
sw0:admin> cfgenable "cfg1"
You are about to enable a new zoning configuration.
This action will replace the old zoning configuration with the
current configuration selected. If the update includes changes
to one or more traffic isolation zones, the update may result in
localized disruption to traffic on ports associated with
the traffic isolation zone changes
Do you want to enable 'cfg1' configuration (yes, y, no, n): [no] y
zone config "cfg1" is in effect
Updating flash ...
sw0:admin> portcfgqos --enable 3
```

## Setting QoS zone-based traffic prioritization over FC routers

1. Connect to the switch in the edge fabric and log in using an account with admin permissions.
2. Create QoS zones in the edge fabric.  
The QoS zones must have WWN members only, and not D,I members. See [“Setting QoS zone-based traffic prioritization”](#) on page 429 for instructions.
3. Create LSAN zones in the edge fabric.  
See [“Controlling device communication with the LSAN”](#) on page 486 for instructions.
4. Enter the **portCfgQos** command to enable QoS on the E\_Ports.
5. Repeat [step 1](#) through [step 3](#) to create QoS zones and LSAN zones on the other edge fabric.
6. Connect to the FC router in the backbone fabric and log in using an account with admin permissions.
7. Enter the **portCfgQos** command to enable QoS on the EX\_Ports.

## Disabling QoS zone-based traffic prioritization

1. Connect to the switch and log in using an account with admin permissions.
2. Enter the **cfgRemove** command to remove the QoS zones from the current zone configuration.
3. Enter the **portCfgQos** command to disable QoS on the E\_Ports.

## 21 Disabling QoS zone-based traffic prioritization

# Managing Trunking Connections

---

## In this chapter

- Trunking overview ..... 433
- Requirements for trunk groups. .... 435
- Supported configurations for trunking. .... 436
- Supported platforms for trunking. .... 436
- Recommendations for trunking groups ..... 437
- Configuring trunk groups. .... 437
- Enabling trunking on a port or switch ..... 438
- Disabling trunking on a port or switch ..... 438
- Displaying trunking information ..... 439
- ISL trunking over long distance fabrics ..... 440
- EX\_Port trunking ..... 440
- F\_Port trunking ..... 442
- Configuring F\_Port trunking for Access Gateway. .... 447
- Configuring F\_Port trunking for Brocade adapters ..... 448
- Displaying F\_Port trunking information ..... 448
- Disabling F\_Port trunking ..... 449
- Enabling the DCC policy on a trunk area ..... 449

## Trunking overview

The trunking feature optimizes the use of bandwidth by allowing a group of links to merge into a single logical link, called a *trunk group*. Traffic is distributed dynamically and in order over this trunk group, achieving greater performance with fewer links. Within the trunk group, multiple physical ports appear as a single port, thus simplifying management. Trunking also improves system reliability by maintaining in-order delivery of data and avoiding I/O retries if one link within the trunk group fails.

Trunking is frame-based instead of exchange-based. Since a frame is much smaller than an exchange, this means that frame-based trunks are more granular and better balanced than exchange-based trunks and provide maximum utilization of links.

The Trunking license is required for any type of trunking, and must be installed on each switch that participates in trunking. For details on obtaining and installing licensed features, see [Chapter 18, “Administering Licensing”](#).

## Types of trunking

Trunking can be between two switches, between a switch and an Access Gateway module, or between a switch and a Brocade adapter. The types of trunking are as follows:

- **ISL trunking**, or E\_Port trunking, is configured on an inter-switch link (ISL) between two Fabric OS switches and is applicable only to E\_Ports.
- **ICL trunking** is configured on an inter-chassis link (ICL) between two Backbones and is applicable only to ports on the core blades.

Refer to [Chapter 19, “Inter-chassis Links”](#) for detailed information about ICL trunking.

- **EX\_Port trunking** is configured on an inter-fabric link (IFL) between an FC router (EX\_Port) and an edge fabric (E\_Port). The trunk ports are EX\_Ports connected to E\_Ports.

See [“EX\\_Port frame trunking configuration”](#) on page 484 for additional information about EX\_Port trunking.

- **F\_Port trunking** is configured on a link between a switch and either an Access Gateway module or a Brocade adapter. The trunk ports are F\_Ports (on the switch) connected to N\_Ports (on the Access Gateway or adapter).
- **N\_Port Trunking** is configured on a link between a switch and either an Access Gateway module or a Brocade adapter. It is the same as F\_Port trunking. The trunk ports are N\_Ports (on the Access Gateway or adapter) connected to F\_Ports (on the switch).

For more information, see [“Configuring F\\_Port trunking for Brocade adapters”](#) on page 448, the *Access Gateway Administrator’s Guide*, and the *Brocade Adapters Administrators Guide* for more information about configuring this type of trunking.

---

### NOTE

This chapter uses the term *F\_Port trunking* to refer to a trunk between the F\_Ports on a switch and the N\_Ports on either an Access Gateway module or a Brocade adapter. This type of trunk might be referred to as N\_Port trunking in the *Access Gateway Administrator’s Guide* or *Brocade Adapters Administrator’s Guide*.

---

## Masterless trunking

Masterless trunking means that if the master port goes offline, one of the slave ports automatically becomes the new master port, thus avoiding traffic disruption. The new master port uses the old master port area and the old master port is assigned a new, unused area. In this way, the PID of the trunk does not change if the master port goes offline.

If trunking is not masterless, and if the master port goes offline, traffic disruption can occur because the slave ports in the trunk group go offline to select the new master port and then come back online.

Masterless trunking is supported for most platforms and trunking types:

- All F\_Port trunking is masterless.
- ISL and ICL trunking is masterless.
- EX\_Port trunking is masterless, except for the following:
  - Backbones with VF disabled.



## License requirements for trunking

All types of trunking require the Trunking license. This license must be installed on each switch that participates in trunking.

---

### ATTENTION

After you add the Trunking license, to enable trunking functionality, you must disable and then re-enable each port to be used in trunking, or disable and re-enable the switch.

---

Note the following additional license requirements:

- For ICL trunking, each platform forming the ICL connection also requires the ICL license.
- For F\_Port trunking between a switch and a Brocade HBA, the switch connected to the HBA also requires the Server Application Optimization (SAO) license.

See [Chapter 18, “Administering Licensing,”](#) for information about activating licenses.

## Port groups for trunking

For trunk groups to form, several conditions must be met, one of which is that all of the ports in a trunk group must belong to the same port group. A *port group* is a group of eight ports, based on the user port number, such as 0–7, 8–15, 16–23, and up to the number of ports on the switch. The maximum number of port groups is platform-specific.

[Figure 69](#) shows the port groups for the Brocade 5100.

Ports in a port group are usually contiguous, but might not be. Refer to the hardware reference manual for your switch for information about which ports can be used in the same port group for trunking.

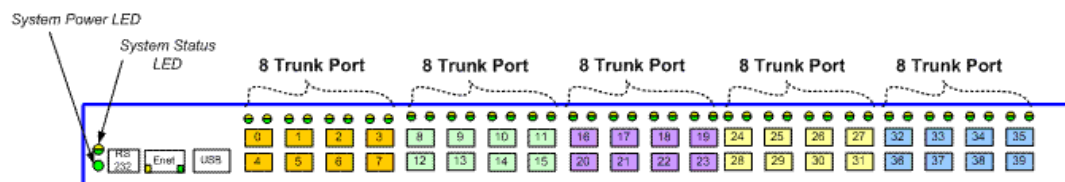

FIGURE 69 Trunk group configuration for the Brocade 5100

## Requirements for trunk groups

The following requirements apply to all types of trunking:

- The Trunking license must be installed on every switch that participates in trunking.
- All of the ports in a trunk group must belong to the same port group.
- All of the ports in a trunk group must be running at the same speed.
- All of the ports in a trunk group must be configured for the same distance.
- All of the ports in a trunk group must have the same encryption, compression, QoS, and FEC settings.
- Trunk groups must be between Brocade switches (or Brocade adapters, in the case of F\_Port trunking). Brocade trunking is proprietary and not supported on M-EOS or third-party switches.
- There must be a direct connection between participating switches.

- Trunking cannot be done if ports are in ISL R\_RDY mode. (You can disable this mode using the `portCfgIslMode` command.)
- Trunking is supported only on FC ports. Virtual FC ports (VE\_ or VEX\_Ports) do not support trunking.

## Supported configurations for trunking

- Trunk links can be 2 Gbps, 4 Gbps, 8 Gbps, 10 Gbps, or 16 Gbps depending on the Brocade platform.
- The maximum number of ports per trunk and trunks per switch depends on the Brocade platform.
- You can have up to eight ports in one trunk group to create high performance ISL trunks between switches with up to 128 Gbps (based on 16 Gbps port speed).
- If in-flight encryption/compression is enabled, you can have a maximum of only two ports per trunk.
- An E\_Port or EX\_Port trunk can be up to eight ports wide. All the ports must be adjacent to each other using the clearly marked groups on the front of the product.

Trunks operate best when the cable length of each trunked link is roughly equal to the others in the trunk. For optimal performance, no more than 30 meters difference is recommended. Trunks are compatible with both short wavelength (SWL) and long wavelength (LWL) fiber optic cables and transceivers.

Trunking is performed based on the Quality of Service (QoS) configuration on the master and the slave ports. That is, in a given trunk group, if there are some ports with QoS enabled and some with QoS disabled, they form two different trunks, one with QoS enabled and the other with QoS disabled. For more information on QoS, refer to [“QoS zones”](#) on page 424.

## High availability support for trunking

Trunking is a High Availability (HA) supported feature. The HA protocol for trunking is as follows:

- If trunking is disabled prior to the HA failover, it remains disabled after the HA failover.
- If trunking is enabled prior to the HA failover, it remains enabled after the HA failover.

## Supported platforms for trunking

Trunking is supported on the FC ports of all Brocade platforms and blades supported in Fabric OS v7.0.0.

EX\_Port trunking is supported only on those platforms that support EX\_Ports. See [“Supported platforms for FC-FC routing”](#) on page 466 for more information.

## Recommendations for trunking groups

To identify the most useful trunking groups, consider the following recommendations along with the standard guidelines for SAN design:

- Evaluate the traffic patterns within the fabric.
- Place trunking-capable switches adjacent to each other.

This maximizes the number of trunking groups that can form. If you are using a core and edge topology, place trunking-capable switches at the core of the fabric and any switches that are not trunking-capable at the edge of the fabric.

- When connecting two switches with two or more ISLs, ensure that all trunking requirements are met to allow a trunking group to form.
- Determine the optimal number of trunking groups between each set of linked switches, depending on traffic patterns and port availability.

The goal is to avoid traffic congestion without unnecessarily using ports that could be used to attach other switches or devices. Consider these points:

- Each physical ISL uses two ports that could otherwise be used to attach node devices or other switches.
- Trunking groups can be used to resolve ISL oversubscription if the total capability of the trunking group is not exceeded.
- Consider how the addition of a new path will affect existing traffic patterns:
  - A trunking group has the same link cost as the master ISL of the group, regardless of the number of ISLs in the group. This allows slave ISLs to be added or removed without causing data to be rerouted, because the link cost remains constant.
  - The addition of a path that is shorter than existing paths causes traffic to be rerouted through that path.
  - The addition of a path that is longer than existing paths may not be useful because the traffic will choose the shorter paths first.
- Plan for future bandwidth addition to accommodate increased traffic.

For trunking groups over which traffic is likely to increase as business requirements grow, consider leaving one or two ports in the group available for future nondisruptive addition of bandwidth.

- Consider creating redundant trunking groups where additional ports are available or paths are particularly critical.

This helps to protect against oversubscription of trunking groups, multiple ISL failures in the same group, and the rare occurrence of an ASIC failure.

- To provide the highest level of reliability, deploy trunking groups in redundant fabrics to further ensure that ISL failures do not disrupt business operations.

## Configuring trunk groups

After you install the Trunking license, you must re-initialize the ports that are to be used in trunk groups so that they recognize that trunking is enabled. This procedure needs to be performed only one time, and is required for all types of trunking.

To re-initialize the ports, you can either disable and then re-enable the switch, or disable and then re-enable the affected ports.

1. Connect to the switch and log in using an account assigned to the admin role.
2. Enter the **isIShow** command to determine which ports are used for ISLs.
3. Enter the **portDisable** command for each port to be used in a trunk group.  
Alternatively, you can enter the **switchDisable** command to disable all ports on the switch.
4. Enter the **portEnable** command for each port that you disabled in [step 3](#), or enter the **switchEnable** command to enable all of the ports on the switch.

---

### NOTE

F\_Port trunking requires additional steps to configure the Trunk Area (TA). See [“Configuring F\\_Port trunking for Access Gateway”](#) on page 447 or [“Configuring F\\_Port trunking for Brocade adapters”](#) on page 448 for information.

---

## Enabling trunking on a port or switch

You can enable trunking for a single port or for an entire switch. Since trunking is automatically enabled when you install the Trunking license, you need to use this procedure only if trunking has been subsequently disabled on a port or switch. Enabling trunking disables and re-enables the affected ports. As a result, traffic through these ports may be temporarily disrupted.

1. Connect to the switch and log in using an account assigned to the admin role.
2. Enter the **portCfgTrunkPort** command to enable trunking on a port.  
Enter the **switchCfgTrunk** command to enable trunking on all ports on the switch.

Mode 1 enables and mode 0 disables trunking.

In the following example, trunking is being enabled on slot 1, port 3.

```
switch:admin> portcfgtrunkport 1/3 1
```

## Disabling trunking on a port or switch

You can disable trunking for a single port or for an entire switch. Disabling trunking disables and re-enables the affected ports. As a result, traffic through these ports may be temporarily disrupted.

Trunking on ICLs is always enabled and cannot be disabled.

Disabling trunking fails if a Trunk Area (TA) is enabled on the port. Use the **portTrunkArea** command to remove the TA before disabling trunking.

1. Connect to the switch and log in using an account assigned to the admin role.
2. Enter the **portCfgTrunkPort** command to disable trunking on a port.  
Enter the **switchCfgTrunk** command to disable trunking on all ports on the switch.

Mode 1 enables and mode 0 disables trunking.

```
switch:admin> switchcfgtrunk 0
```

## Displaying trunking information

You can use the **trunkShow** command to view the following information:

- All the trunks and members of a trunk.
- Whether the trunking port connection is the master port connection for the trunking group.
- That trunks are formed correctly.
- Trunking information for a switch that is part of an FC Router backbone fabric interlinking several edge fabrics.
- Trunking information, including bandwidth and throughput for all the trunk groups in a switch.

Use the **portPerfShow** command to monitor problem areas where there are congested paths or dropped links to determine if you need to adjust the fabric design by adding, removing, or reconfiguring ISLs and trunking groups. For additional information on the Brocade Advanced Performance Monitor to monitor traffic, see [Chapter 20, “Monitoring Fabric Performance”](#).

To view detailed information about F\_Port trunking, see [“Displaying F\\_Port trunking information”](#) on page 448.

1. Connect to the switch and log in using an account assigned to the admin role.
2. Enter the **trunkShow** command.

This example shows trunking groups 1, 2, and 3; ports 4, 13, and 14 are masters.

```
switch:admin> trunkshow
1: 6-> 4 10:00:00:60:69:51:43:04 99 deskew 15 MASTER

2: 15-> 13 10:00:00:60:69:51:43:04 99 deskew 16 MASTER
    12-> 12 10:00:00:60:69:51:43:04 99 deskew 15
    14-> 14 10:00:00:60:69:51:43:04 99 deskew 17
    13-> 15 10:00:00:60:69:51:43:04 99 deskew 16

3: 24-> 14 10:00:00:60:69:51:42:dd 2 deskew 15 MASTER
```

This example shows trunking information along with the bandwidth and throughput for all the trunk groups in a switch.

```
switch:admin> trunkshow -perf
1: 2-> 2 10:00:00:05:1e:81:56:8b 1 deskew 15 MASTER
    3-> 3 10:00:00:05:1e:81:56:8b 1 deskew 17
    Tx: Bandwidth 4.00Gbps, Throughput 1.66Gbps (48.45%)
    Rx: Bandwidth 4.00Gbps, Throughput 1.66Gbps (48.44%)
    Tx+Rx: Bandwidth 8.00Gbps, Throughput 3.33Gbps (48.44%)

2: 5->113 10:00:00:05:1e:46:42:01 3 deskew 15 MASTER
    4->112 10:00:00:05:1e:46:42:01 3 deskew 15
    Tx: Bandwidth 16.00Gbps, Throughput 1.67Gbps (12.12%)
    Rx: Bandwidth 16.00Gbps, Throughput 1.67Gbps (12.12%)
    Tx+Rx: Bandwidth 32.00Gbps, Throughput 3.33Gbps (12.12%)

3: 10-> 10 10:00:00:05:1e:81:56:8b 1 deskew 15 MASTER
    11-> 11 10:00:00:05:1e:81:56:8b 1 deskew 15
    Tx: Bandwidth 4.00Gbps, Throughput 1.66Gbps (48.45%)
    Rx: Bandwidth 4.00Gbps, Throughput 1.67Gbps (48.48%)
    Tx+Rx: Bandwidth 8.00Gbps, Throughput 3.33Gbps (48.46%)

4: 12->892 10:00:00:05:1e:46:42:01 3 deskew 15 MASTER
    13->893 10:00:00:05:1e:46:42:01 3 deskew 15
```

```
Tx: Bandwidth 16.00Gbps, Throughput 1.67Gbps (12.12%)
Rx: Bandwidth 16.00Gbps, Throughput 1.66Gbps (12.11%)
Tx+Rx: Bandwidth 32.00Gbps, Throughput 3.33Gbps (12.11%)
```

## ISL trunking over long distance fabrics

In long-distance fabrics, if a port speed is set to autonegotiate, then the maximum speed, which is 16 Gbps, is assumed for reserving buffers for the port. If the port is only running at 2 Gbps, this wastes buffers. For long-distance ports, you should specify the port speed instead of setting it to autonegotiate.

In addition to the criteria listed in [“Supported configurations for trunking”](#) on page 436, observe the following criteria for trunking over extended fabrics:

- It is supported only on switches running Fabric OS v6.1.0 and later.
- Extended Fabrics and Trunking licenses are required on all participating switches.
- When configuring long distance, the `portCfgLongDistance --vc_translation_link_init` parameter must be set the same on all ports in an extended fabric.

For additional information on configuring long distance, see [“Configuring an extended ISL”](#) on page 453.

[Table 75](#) describes Trunking over long distance support for the Backbones and supported blades.

**TABLE 75** Trunking over distance for the Backbones

Long distance mode	Distance	Number of 2 Gbps ports	Number of 4 Gbps ports
LE	10 km	48 (six 8-port trunks)	48 (six 8-port trunks)
L0	Normal	See note below	48 (six 8-port trunks)
LD	200 km	4 (one 2-port trunk per switch)	0
LD	250 km	4 (one 2-port trunk per switch)	0
LD	500 km	0	0
LS	Static	See note below	

### NOTE

The L0 mode supports up to 5 km at 2 Gbps, up to 2 km at 4 Gbps, and up to 1 km at 8 Gbps. The distance for the LS mode is static. You can specify any distance greater than 10 km.

The distance supported depends on the available buffers, number of back-end ports, and the number of ports that are offline. For more information on setting port speeds, refer to [Chapter 3, “Performing Advanced Configuration Tasks”](#).

## EX\_Port trunking

You can configure EX\_Ports to use trunking just as you do regular E\_Ports. EX\_Port trunking support is designed to provide the best utilization and balance of frames transmitted on each link between the FC router and the edge fabric. You should trunk all ports connected to the same edge fabrics.

The FC router front domain has a higher node WWN—derived from the FC router—than that of the edge fabric. Therefore, the FC router front domain initiates the trunking protocol on the EX\_Port.

After initiation, the first port from the trunk group that comes online is designated as the master port. The other ports that come online on the trunk group are considered the slave ports. Adding or removing a slave port does not cause frame drop; however, removing a slave port causes the loss of frames in transit.

The restrictions for EX\_Port frame trunking are the same as for E\_Ports—all the ports must be adjacent to each other using the clearly marked groups on the front of the product.

---

#### ATTENTION

This feature should be enabled only if the entire configuration is running Fabric OS v5.2.0 or later.

---

If router port cost is used with EX\_Port trunking, the master port and slave ports share the router port cost of the master port.

See [Chapter 24, “Using FC-FC Routing to Connect Fabrics,”](#) for more information about EX\_Ports and the FC router.

## Masterless EX\_Port trunking

EX\_Port trunking is masterless except for EX\_Ports on Backbones.

For the Backbones, Virtual Fabrics must be enabled for masterless EX\_Port trunking to take effect. For the fixed-port switches, Virtual Fabrics can be enabled or disabled.

If masterless EX\_Port trunking is not in effect and the master port goes offline, the entire EX\_Port-based trunk re-forms and is taken offline for a short period of time. If there are no other links to the edge fabric from the backbone, the master port going offline may cause a traffic disruption in the backbone.

## Supported configurations and platforms for EX\_Port trunking

EX\_Port trunking is an FCR software feature and requires that you have a Trunking license installed on the FC router and on the edge fabric connected to the other side of the trunked EX\_Ports. EX\_Port trunking is supported only with Brocade edge fabrics. You can use EX\_Port frame trunking in the following configurations and cases:

- For ports with speeds of 2 Gbps up to a maximum speed of 16 Gbps and trunking over long distance.
- In the edge fabric, when the FC router is connected to a switch that supports eight ports from the trunkable group.
- When the FC router is connected to an edge fabric using a mix of trunked and non-trunked EX\_Ports. All will share the same front domain.
- In edge-to-edge, backbone-to-edge, and dual backbone configurations.

Masterless EX\_Port trunking has additional configuration requirements. See [“Masterless EX\\_Port trunking”](#) for these additional requirements.

---

#### NOTE

QoS and EX\_Port trunking can co-exist; however, if some ports in the trunk group have QoS enabled and some have QoS disabled, then two trunk groups will form: one with QoS enabled and one with QoS disabled.

---

### *Backward compatibility support*

For backward compatibility, an FC router that supports EX\_Port trunking can continue to interoperate with older FC routers and all previously supported Brocade switches in the backbone fabric or Brocade edge fabric.

## Configuring EX\_Port trunking

With EX\_Port trunking, you use the same CLI commands as you do for E\_Port trunking. See [“Configuring trunk groups”](#) on page 437 for instructions.

## Displaying EX\_Port trunking information

1. Log in as an admin and connect to the switch.
2. Enter the **switchShow** command to display trunking information for the EX\_Ports.

The following is an example of a master EX\_Port and a slave EX\_Port displayed in **switchShow**.

```
fcr_switch:admin_06> switchshow
```

```
Index Slot Port Address Media Speed State
=====
16 2 0 ee1000 id N4 No_Light
17 2 1 ee1100 id N4 Online EX_Port (Trunk port, master is Slot 2 Port 2 )
18 2 2 ee1200 id N4 Online EX_Port 10:00:00:05:1e:35:bb:32 "MtOlympus_82"
(fabric id = 2 ) (Trunk master)
19 2 3 ee1300 id N4 No_Light
20 2 4 ee1400 id N4 Online EX_Port (Trunk port, master is Slot 2 Port 7 )
21 2 5 ee1500 id N4 Online EX_Port (Trunk port, master is Slot 2 Port 7 )
22 2 6 ee1600 id N4 Online EX_Port (Trunk port, master is Slot 2 Port 7 )
23 2 7 ee1700 id N4 Online EX_Port 10:00:00:60:69:80:1d:bc "MtOlympus_72"
(fabric id = 2 ) (Trunk master)
```

## F\_Port trunking

You can configure F\_Port trunking in the following scenarios:

- Between F\_Ports on a Fabric OS switch and N\_Ports on an Access Gateway module
- Between F\_Ports on a Fabric OS switch and N\_Ports on a Brocade adapter

For F\_Port trunking, you must create a Trunk Area (TA) within the trunk group. When you assign an area within a trunk group, that group is F\_Port trunking enabled. The TA that you assign must be within the 8-port trunk group beginning with port 0 (zero). After you assign a TA to a port, the port immediately acquires the TA as the area of its PID. Likewise, after you remove a TA from a port, the port immediately acquires the default area as its PID. F\_Port trunking prevents reassignments of the Port ID, also referred to as the Address Identifier, when F\_Ports go offline, and it increases F\_Port bandwidth.

This chapter describes how you configure F\_Port trunking on the switch. See the *Access Gateway Administrator's Guide* and the *Brocade Adapters Administrator's Guide* for information about configuring the corresponding N\_Port trunking on the Access Gateway and the Brocade adapter.



## F\_Port trunking for Access Gateway

You can configure trunking between the F\_Ports on an edge switch and the N\_Ports on an Access Gateway module.

**NOTE**

You cannot configure F\_Port trunking on the F\_Ports of an Access Gateway module.

F\_Port trunking keeps F\_Ports from becoming disabled when they are mapped to an N\_Port on a switch in Access Gateway mode. With F\_Port trunking, any link within a trunk can go offline or become disabled, but the trunk remains fully functional and there are no reconfiguration requirements.

Figure 70 shows a switch in AG mode without F\_Port masterless trunking. Figure 71 shows a switch in AG mode with F\_Port masterless trunking.

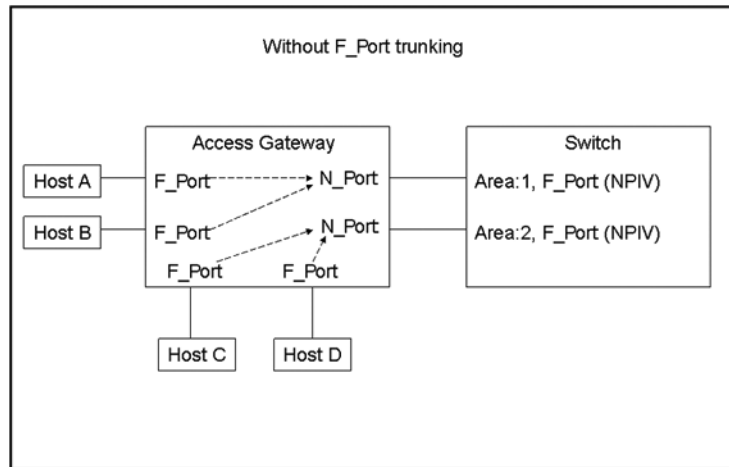

FIGURE 70 Switch in Access Gateway mode without F\_Port trunking

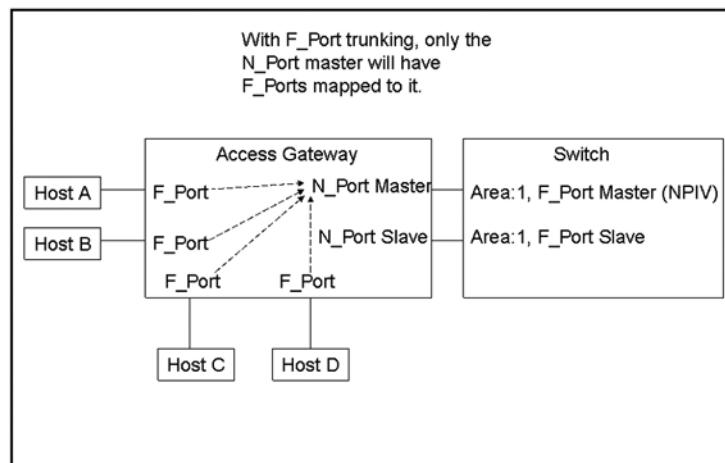

FIGURE 71 Switch in Access Gateway mode with F\_Port masterless trunking

**NOTE**

You do not need to manually map the host to the master port because Access Gateway will perform a cold failover to the master port.

See [“Configuring F\\_Port trunking for Access Gateway”](#) on page 447 for instructions on configuring F\_Port trunking.

## Requirements for F\_Port trunking on an Access Gateway

In addition to the requirements listed in [“Requirements for trunk groups”](#) on page 435, refer to the *Access Gateway Administrator’s Guide* for additional requirements that are specific to F\_Port trunking on an Access Gateway.

## F\_Port trunking for Brocade adapters

You can configure trunking between the F\_Ports on an edge switch and the Brocade adapters.

In addition to the requirements listed in [“Requirements for trunk groups”](#) on page 435, note the following requirements, which are specific to F\_Port trunking for Brocade adapters:

- The edge switch must be running in Native mode. You cannot configure trunking between the Brocade adapters and the F\_Ports of an Access Gateway module.
- You can configure only two F\_Ports in one trunk group.

See the *Brocade Adapters Administrator’s Guide* for information about configuring the corresponding N\_Port trunking on the Access Gateway and the Brocade adapter.

## F\_Port trunking considerations

[Table 76](#) describes the F\_Port trunking considerations.

**TABLE 76** F\_Port masterless considerations

Category	Description
AD	You cannot create a Trunk Area on ports with different Admin Domains. You cannot create a Trunk Area in AD255.
Area assignment	You statically assign the area within the trunk group on the edge switch. That group is the F_Port trunk. The static trunk area you assign must fall within the ASIC’s trunk group of the switch or blade starting from port 0, and must be one of the port’s default areas of the trunk group.  10-bit addressing is the default mode for all dynamically created partitions in the Brocade DCX and DCX 8510-8 platforms.
Authentication	Authentication occurs only on the F_Port trunk master port and only once per the entire trunk. This behavior is the same as E_Port trunk master authentication. Because only one port in the trunk does FLOGI to the switch, and authentication follows FLOGI on that port, only that port displays the authentication details when you issue the <b>portShow</b> command.

**NOTE:** Switches in Access Gateway mode do not perform authentication.

TABLE 76 F\_Port masterless considerations (Continued)

Category	Description
configdownload	<p>If you issue the <b>configDownload</b> command for a port configuration that is not compatible with F_Port trunking, and the port is Trunk Area-enabled, then the port will be persistently disabled. F_Port trunks will never be restored through <b>configDownload</b>.</p> <p><b>NOTE:</b> Configurations that are not compatible with F_Port trunking are long distance, port mirroring, non-CORE_PID, and Fast Write.</p>
domain,index (D,I)	<p>Creating a Trunk Area may remove the Index ("I") from the switch to be grouped to the Trunk Area. All ports in a Trunk Area share the same "I". This means that <i>domain,index</i> (D,I), which refer to an "I" that might have been removed, will no longer be part of the switch.</p> <p><b>NOTE:</b> Ensure to include AD, zoning, and DCC when creating a Trunk Area.</p> <p>You can remove the port from the Trunk Area to have the "I" back into effect. D,I behaves as normal, but you may see the effects of grouping ports into a single "I".</p> <p>Also, D,I continues to work for Trunk Area groups. The "I" can be used in D,I if the "I" was the "I" for the Trunk Area group.</p>
DCC Policy	<p>DCC policy enforcement for the F_Port trunk is based on the Trunk Area; the FDISC requests to a trunk port are accepted only if the WWN of the attached device is part of the DCC policy against the TA. The PWWN of the FLOGI sent from the AG will be dynamic for the F_Port trunk master. Because you do not know ahead of time what PWWN AG will use, the PWWN of the FLOGI will not go through DCC policy check on an F_Port trunk master. However, the PWWN of the FDISC will continue to go through DCC policy check.</p>
Default Area	<p>Port X is a port that has its Default Area the same as its Trunk Area. The only time you can remove port X from the trunk group is if the entire trunk group has the Trunk Area disabled.</p>
Downgrade	<p>You can have trunking on, but you must disable the trunk ports before performing a firmware downgrade.</p> <p><b>Note:</b> Removing a Trunk Area on ports running traffic is disruptive because you must disable the port to disable the Trunk Area on the port. Use caution before assigning a Trunk Area if you need to downgrade to a firmware version earlier than Fabric OS v6.2.0.</p>
Fastwrite	<p>When you assign a Trunk Area to a trunk group, the trunk group cannot have Fastwrite enabled on those ports; if a port is Fastwrite-enabled, the port cannot be assigned a Trunk Area.</p>
FICON	<p>FICON is not supported on F_Port trunk ports. However, FICON can still run on ports that are not F_Port trunked within the same switch.</p>
HA Sync	<p>If you plug in a standby CP with a firmware version earlier than Fabric OS v6.2.0 and a Trunk Area is present on the switch, the CP blades will become out of sync.</p>
Long Distance	<p>Long distance is not allowed on F_Port trunks, which means a Trunk Area is not allowed on long-distance ports; you cannot enable long distance on ports that have a Trunk Area assigned to them.</p>
Management Server	<p>Registered Node ID (RNID), Link Incident Record Registration (LIRR), and Query Security Attribute (QSA) ELSS are not supported on F_Port trunks.</p>
NPIV	<p>Supported on F_Port master trunk.</p>
PID format	<p>F_Port trunking is only supported in the CORE PID format.</p>
Port mirroring	<p>Port mirroring is not supported on Trunk Area ports or on the PID of an F_Port trunk port.</p>

**TABLE 76 F\_Port masterless considerations (Continued)**

Category	Description
Port Swap	When you assign a Trunk Area to a trunk group, the Trunk Area cannot be port swapped; if a port is swapped, then you cannot assign a Trunk Area to that port.
Port Types	Only F_Port trunk ports are allowed on a Trunk Area port. All other port types are persistently disabled.
PWWN	The entire Trunk Area trunk group shares the same Port WWN within the trunk group. The PWWN is the same across the F_Port trunk that has 0x2f or 0x25 as the first byte of the PWWN. The TA is part of the PWWN in the format listed in <a href="#">Table 77</a> on page 446.
QoS	Supported.
Routing	Routing will route against the F_Port trunk master. Bandwidth information will be modified accordingly as the F_Port trunk forms.
Trunk Master	No more than one trunk master in a trunk group. The second trunk master will be persistently disabled with reason "Area has been acquired".
Upgrade	There are no limitations on upgrading to Fabric OS v7.0.0 if the F_Port is present on the switch. Upgrading is not disruptive.

[Table 77](#) describes the PWWN format for F\_Port and N\_Port trunk ports.

**TABLE 77 PWWN format for F\_Port and N\_Port trunk ports**

NAA = 2	2f:xx:nn:nn:nn:nn:nn	Port WWNs for: switch's Fx_Ports.	The valid range of xx is [0 - FF], for maximum of 256.
NAA = 2	25:xx:nn:nn:nn:nn:nn	Port WWNs for: switch's FX_Ports	The valid range of xx is [0 - FF], for maximum of 256.

## Trunk Area and Admin Domains

Ports from different ADs are not allowed to join the same Trunk Area group. The **portTrunkArea** command prevents the different ADs from joining the TA group.

When you assign a TA, the ports within the TA group have the same Index. The Index that was assigned to the ports is no longer part of the switch. Any Domain,Index (D,I) AD that was assumed to be part of the domain may no longer exist for that domain because it was removed from the switch.

### Example of how Trunk Area assignment affects the port Domain,Index

If you have AD1: 3,8; 3,9; 4,13; 4,14 and AD2: 3,10; 3,11, and then create a TA with Index 8 with ports that have index 8, 9, 10, and 11, then index 9, 10, and 11 are no longer with domain 3. This means that AD2 does not have access to any ports because index 10 and 11 no longer exist on domain 3. This also means that AD1 no longer has 3,9 in effect because Index 9 no longer exists for domain 3. Port 3,8, which is the TA group, can still be seen by AD1 along with 4,13 and 4,14.

If a port within a TA is removed, the Index is added back to the switch. For example, the same AD1 and AD2 with TA 8 holds true. If you remove port 9 from the TA, it adds Index 9 back to the switch. That means port 3,9 can be seen by AD1 along with 3,8; 4,13 and 4,14.

## F\_Port trunking in Virtual Fabrics

F\_Port trunking functionality performs the same in Virtual Fabrics as it does in non-virtual fabric platforms except for the Brocade DCX and DCX 8510-8. Fabric OS uses a 10-bit addressing model, which is the default mode for all dynamically created logical switches in the DCX platform.

In the DCX and DCX 8510 platforms, F\_Port trunk ports dynamically receive an 8-bit area address that remains persistent. After F\_Port trunking configurations are removed from a port in a logical switch, that port returns to the default 10-bit area address model, which supports up to 1024 F\_Ports in a logical switch.

---

### NOTE

Because the DCX and DCX 8510-8 platforms have a maximum of 576 ports, out of the 1024 10-bit address range, addresses 448-1023 are reserved for the 10-bit address space. Addresses 0-447 are reserved for assigning to NPIV/Loop ports to support 112 [448/4] NPIV/Loop ports in a logical switch with 256 devices each.

---

Following are the F\_Port trunking considerations for virtual fabrics:

- If a port is enabled for F\_Port trunking, then you must disable the configuration before you can move a port from the logical switch.
- If the user bound area for a port is configured using the **portAddress** command, then the port cannot be configured as an F\_Port trunk port. You must explicitly remove the user bound area before enabling F\_Port trunking.
- If you swap a port using the **portSwap** command, then you must undo the port swap before enabling F\_Port trunking.
- The Port WWN format in a Virtual Fabric is 2z:zz:xx:xx:xx:xx:xx:xx. The z:zz is the logical port number, for example, the logical port 450 will be 1:c2. The xx:xx:xx:xx:xx:xx is based on the logical fabric WWN.

For example, if the logical fabric WWN is 10:00:00:05:1e:39:fa:f3, and logical port number is 450, then the Port WWN of the F\_Port trunk will be 21:c2: 00:05:1e:39:fa:f3.

- F\_Port trunks are not allowed on the base switch because you cannot have F\_Ports on the base switch.
- If F\_Port trunking is enabled on some ports in the default switch, and you disable Virtual Fabrics, all of the F\_Port trunking information is lost.
- All of the ports in an F\_Port trunk must belong to a single trunk group of ports on the platform and must also belong to the same logical switch.

See [Chapter 10, "Managing Virtual Fabrics,"](#) for detailed information about Virtual Fabrics.

## Configuring F\_Port trunking for Access Gateway

Access Gateway trunking configuration is mostly on the edge switch. On the Access Gateway module, you only need to ensure that the trunking license is applied and enabled.

Perform the following procedure on the edge switch connected to the Access Gateway module.

1. Connect to the switch and log in using an account assigned to the admin role.
2. Enter the **portCfgShow** command to ensure that the ports have trunking enabled. If trunking is not enabled, enter the **portCfgTrunkPort port 1** command.

3. Enter the **portDisable** command for each port to be included in the TA.
4. Enter the **portTrunkArea --enable** command to enable the trunk area.

For example, the following command creates a TA for ports 36-39 with index number 37.

```
switch:admin> porttrunkarea --enable 36-39 -index 37
Trunk index 37 enabled for ports 36, 37, 38 and 39.
```

When you assign a trunk area on a port, it enables trunking on the F\_Ports automatically. This command does not unassign a TA if its previously assigned Area\_ID is the same address identifier (Area\_ID) of the TA unless all the ports in the trunk group are specified to be unassigned.

5. Enter the **portEnable** command to re-enable the ports in the TA.

## Configuring F\_Port trunking for Brocade adapters

F\_Port trunking for Brocade adapters requires configuration on the FC switch as well as on the Brocade HBAs. This section describes the configuration steps you do on the switch. See the *Brocade Adapters Administrator's Guide* for a detailed description and requirements of N\_Port trunking on the adapters.

1. On the switch side, perform the following steps:
  - a. Configure both ports for trunking using the **portCfgTrunkPort** command.

```
switch:admin> portcfgtrunkport 3/40 1
switch:admin> portcfgtrunkport 3/41 1
```
  - b. Disable the ports to be used for trunking using the **portDisable** command.

```
switch:admin> portdisable 3/40
switch:admin> portdisable 3/41
```
  - c. Enable the trunk on the ports using the **portTrunkArea** command.

```
switch:admin> porttrunkarea --enable 3/40-41 -index 296
Trunk index 296 enabled for ports 3/40 and 3/41.
```
2. On the host side, enable trunking as described in the *Brocade Adapters Administrator's Guide*.
3. On the switch side, enable the ports using the **portEnable** command.

```
switch:admin> portenable 3/40
switch:admin> portenable 3/41
```

## Displaying F\_Port trunking information

Use the following commands on the edge switch to verify the F\_Port trunking setup.

- Enter the **switchshow** command to display the switch and port information.
- Enter the **porttrunkarea --show enabled** command to display the TA-enabled port configuration.

```
switch:admin> porttrunkarea --show enabled
```

Port	Type	State	Master	TI	DI
36	F-port	Master	36	37	36
37	F-port	Slave	36	37	37
38	F-port	Slave	36	37	38
39	F-port	Slave	36	37	39

- Enter the **porttrunkarea --show trunk** command to display the trunking information.

```
switch:admin> porttrunkarea --show trunk
Trunk Index 37: 39->0 sp: 8.000G bw: 16.000G deskew 15 MASTER
Tx: Bandwidth 16.00Gbps, Throughput 1.63Gbps (11.84%)
Rx: Bandwidth 16.00Gbps, Throughput 1.62Gbps (11.76%)
Tx+Rx: Bandwidth 32.00Gbps, Throughput 3.24Gbps (11.80%)
38->1 sp: 8.000G bw: 8.000G deskew 15
Tx: Bandwidth 16.00Gbps, Throughput 1.63Gbps (11.84%)
Rx: Bandwidth 16.00Gbps, Throughput 1.62Gbps (11.76%)
Tx+Rx: Bandwidth 32.00Gbps, Throughput 3.24Gbps (11.80%)
37->1 sp: 8.000G bw: 8.000G deskew 15
Tx: Bandwidth 16.00Gbps, Throughput 1.63Gbps (11.84%)
Rx: Bandwidth 16.00Gbps, Throughput 1.62Gbps (11.76%)
Tx+Rx: Bandwidth 32.00Gbps, Throughput 3.24Gbps (11.80%)
36->1 sp: 8.000G bw: 8.000G deskew 15
Tx: Bandwidth 16.00Gbps, Throughput 1.63Gbps (11.84%)
Rx: Bandwidth 16.00Gbps, Throughput 1.62Gbps (11.76%)
Tx+Rx: Bandwidth 32.00Gbps, Throughput 3.24Gbps (11.80%)
```

## Disabling F\_Port trunking

1. Connect to the switch and log in using an account assigned to the admin role.
2. Enter the **portDisable** command to disable the ports that are to be removed from the trunk area.
3. Enter the **portTrunkArea --disable** command to remove ports from the trunk area.

This command does not unassign a TA if its previously assigned Area\_ID is the same address identifier (Area\_ID) of the TA unless all the ports in the trunk group are specified to be unassigned.

```
switch:admin> portdisable 0-2
switch:admin> porttrunkarea --disable 0-2
Trunk index 2 disabled for ports 0, 1, and 2.
```

## Enabling the DCC policy on a trunk area

After you assign a trunk area, the **portTrunkArea** CLI checks whether there are any active DCC policies on the port with the index TA, and then issues a warning to add all the device WWNs to the existing DCC policy with index as TA.

All DCC policies that refer to an Index that no longer exists will not be in effect.

1. Add the WWN of all the devices to the DCC policy against the TA.
2. Enter the **secPolicyActivate** command to activate the DCC policy.

You must enable the TA before issuing the **secPolicyActivate** command in order for security to enforce the DCC policy on the trunk ports.

## 22 Enabling the DCC policy on a trunk area

3. Turn on the trunk ports.

Trunk ports should be turned on after issuing the **secPolicyActivate** command to prevent the ports from becoming disabled in the case where there is a DCC security policy violation.

You can configure authentication on all Brocade trunking configurations. For more information on authentication, see [Chapter 7, “Configuring Security Policies”](#).



# Managing Long Distance Fabrics

---

## In this chapter

- [Long distance fabrics overview](#) ..... 451
- [Extended Fabrics device limitations](#) ..... 452
- [Long distance link modes](#) ..... 452
- [Configuring an extended ISL](#) ..... 453
- [Buffer credit management](#) ..... 455
- [Buffer credit recovery](#) ..... 463

## Long distance fabrics overview

The most effective configuration for implementing long-distance SAN fabrics is to deploy Fibre Channel switches at each location in the SAN. Each switch handles local interconnectivity and multiplexes traffic across long-distance dark fiber or wave division multiplexing (WDM) links while the Brocade Extended Fabrics software enables SAN management over long distances. Brocade Extended Fabrics is an optional licensed feature for Brocade SAN deployment over distance beyond 10 km. A Brocade Extended Fabrics license is required before you can implement long distance dynamic (LD) and long distance static (LS) distance levels. The LD and LS settings are necessary to achieve maximum performance results over Inter-Switch Links (ISLs) that are greater than 10 km. For details on obtaining and installing licensed features, see [Chapter 18, “Administering Licensing”](#). The Extended Fabrics feature enables the following:

- **Fabric interconnectivity over Fibre Channel at longer distances**

ISLs can use long distance dark fiber connections to transfer data. Wave division multiplexing, such as DWDM (Dense Wave Division Multiplexing), CWDM (Coarse Wave Division Multiplexing), and TDM (Time Division Multiplexing), can be used to increase the capacity of the links. As Fibre Channel speeds increase, the maximum distance decreases for each switch. The Extended Fabrics feature extends the distance the ISLs can reach over an extended fiber. This is accomplished by providing enough buffer credits on each side of the link to compensate for latency introduced by the extended distance.

- **Simplified management over distance**

Each device attached to the SAN appears as a local device, an approach that simplifies deployment and administration.

- **Optimized switch buffering**

When Extended Fabrics is installed on gateway switches (E\_Port connectivity from one switch to another), the ISLs (E\_Ports) are configured with a large pool of buffer credits. The enhanced switch buffers help ensure that data transfer can occur at near-full bandwidth to efficiently utilize the connection over the extended links. This ensures the highest possible performance on ISLs.

## Extended Fabrics device limitations

Note the limitations regarding the following platforms:

- Brocade 8000 FCoE switch

Extended Fabrics is not supported on this platform.

- FC8-64 port blade

Brocade recommends that you do not use the FC8-64 port blade for long distance, due to limited buffers. This blade does not support LWL and supports limited distance. However, you can use the **portCfgLongDistance** command to reserve frame buffers for the ports intended to be used in long distance mode through DWDM.

There is a limited number of reserved buffers used for long distance for each blade. If some ports are configured in long distance mode and have buffers reserved for them, there may be insufficient buffers for the other ports. In this case, some of the remaining ports may come up in degraded mode.

## Long distance link modes

Use the **portCfgLongDistance** command to support long distance links and to allocate sufficient numbers of full size frame buffers on a particular port. Changes made by this command are persistent across switch reboots and power cycles. This command supports the following long-distance link modes:

- **Static Mode (LO)** - LO is the normal (default) mode for an E\_Port. It configures the E\_Port as a standard (not long distance) ISL. A total of 20 full-size frame buffers are reserved for data traffic, regardless of the E\_Port operating speed; therefore, the maximum supported link distance is up to 5 km at 2 Gbps, up to 2 km at 4 Gbps, and up to 1 km at 8, 10, and 16 Gbps.
- **Static Mode (LE)** - LE configures an E\_Ports distance greater than 5 km and up to 10 km. LE does not require an Extended Fabrics license. The baseline for the buffer credit calculation is one buffer credit per km at 2 Gbps. This yields the following values for 10 km:
  - 10 buffer credits per port at 2 Gbps.
  - 20 buffer credits per port at 4 Gbps.
  - 40 buffer credits per port at 8 Gbps.
  - 50 buffer credits per port at 10 Gbps
  - 80 buffer credits per port at 16 Gbps
- **Dynamic Mode (LD)** - LD calculates BB credits based on the distance measured during port initialization. Brocade switches use a proprietary algorithm to estimate distance across an ISL. The estimated distance is used to determine the BB credits required in LD (Dynamic) extended link mode based on a maximum Fibre Channel payload size of 2,112. You can place an upper limit on the calculation by providing a `desired_distance` value. Fabric OS confines user entries to no larger than what it has estimated the distance to be. When the measured distance is more than `desired_distance`, the `desired_distance` (the smaller value) is used in the calculation.

- **Static Long-Distance Mode (LS)** - LS calculates a static number of BB credits based only on a user-defined `desired_distance` value. LS mode also assumes that all FC payloads are 2112 bytes. Specify LS mode to configure a static long distance link with a fixed buffer allocation greater than 10 km. Up to a total of 1452 full-size frame buffers are reserved for data traffic, depending on the specified `desired_distance` value.

## Configuring an extended ISL

Before configuring an extended ISL, ensure that the following conditions are met:

- The ports on both ends of the ISL are operating at the same port speed, and can be configured at the same distance level without compromising local switch performance.

---

### NOTE

A long-distance link also can be configured to be part of a trunk group. Two or more long-distance links in a port group form a trunk group when they are configured for the same speed, the same distance level, and their link distances are nearly equal. For information on trunking concepts and configurations, refer to [Chapter 22, “Managing Trunking Connections”](#).

---

- Only qualified Brocade SFPs are used. Only Brocade-branded or certain Brocade-qualified SFPs are supported.
1. Connect to the switch and log in using an account assigned to the admin role.
  2. Enter the **switchDisable** command.
  3. Enter the **configure** command to set the switch fabric-wide configurations. You can set the following fabric-wide settings:

(\* = multiplication symbol)

Field	Type	Default	Range
<i>Domain</i>	Number	1	Varies
R_A_TOV	Number	10000	$E\_D\_TOV * 2$ to 120000
E_D_TOV	Number	2000	1000 to $R\_A\_TOV/2$
WAN_TOV	Number	0	0 to $R\_A\_TOV/4$
MAX_HOPS	Number	7	7 to 19

4. For 8 Gbps platforms only, enter the **portCfgFillword** command to set ARB as the fill word.

```
portcfgfillword [slot/]port, mode
```

The *mode* parameter in this command should be set to 3 if the *vc\_translation\_link\_init* parameter in the **portCfgLongDistance** command (in the next step) is set to 1.

5. Enter the **portCfgLongDistance** command.

```
portcfglongdistance [slot/]port [distance_level] [vc_translation_link_init] [desired_distance]
```

6. Repeat [step 5](#) and [step 4](#) for the remote extended ISL port. Both the local and remote extended ISL ports must be configured to the same distance level. When the connection is initiated, the fabric will reconfigure.

**Example**

The following example configures slot 1, port 2 to support a 100 km link in LS mode and be initialized using the extended link initialization sequence. This example is for an 8 Gbps platform.

```
switch:admin> portcfgfillword 1/2 3
switch:admin> portcfglongdistance 1/2 LS 1 100
Reserved Buffers =          406
Warning: port may be reserving more credits depending on port speed.
switch:admin> portshow 1/2
portName:
portHealth: OFFLINE

Authentication: None
portDisableReason: None
portCFlags: 0x1
portFlags: 0x1    PRESENT U_PORT
portType: 17.0
portState: 2     Offline
Protocol: FC
portPhys: 2     No_Module
portScn: 0
port generation number: 0
portId: 010200
portIfId: 4312003b
portWwn: 20:02:00:05:1e:94:0f:00
portWwn of device(s) connected:

Distance: static (desired = 100 Km)
portSpeed: N8Gbps

LE domain: 0
FC Fastwrite: OFF
Interrupts:      0          Link_failure: 0          Frjt:          0
Unknown:        0          Loss_of_sync: 0          Fbsy:          0
Lli:            0          Loss_of_sig: 3
Proc_rqrd:      5          Protocol_err: 0
Timed_out:      0          Invalid_word: 0
Rx_flushed:     0          Invalid_crc: 0
Tx_unavail:     0          Delim_err: 0
Free_buffer:    0          Address_err: 0
Overrun:        0          Lr_in: 0
Suspended:      0          Lr_out: 0
Parity_err:     0          Ols_in: 0
2_parity_err:  0          Ols_out: 0
CMI_bus_err:    0
```

**Enabling long distance when connecting to TDM devices**

Use this procedure when connecting to Time-Division Multiplexing (TDM) devices and your Brocade switch has QoS and buffer credit recovery enabled.

1. Connect to the switch and log in using an account assigned to the admin role.
2. Disable QoS.

```
switch:admin> portcfgqos --disable [slot/]port
```

If you do not disable QoS, after the second or third Link Reset (LR), ARBS display.

3. Disable the credit recovery; credit recovery is not compatible with the IDLE mode. If you do not disable the credit recovery, it continues to perform a link reset.

```
switch:admin> portcfgcreditrecovery --disable [slot/]port
```

4. Configure the port to support long-distance links.

```
switch:admin> portcfglongdistance [slot/]port,LS,0,100
```

## Buffer credit management

Buffer-to-buffer credit management affects performance over distances; therefore, allocating a sufficient number of buffer credits for long-distance traffic is essential to performance.

To prevent a target device (either host or storage) from being overwhelmed with frames, the Fibre Channel architecture provides flow control mechanisms based on a system of credits. Each of these credits represents the ability of the device to accept additional frames. If a recipient issues no credits to the sender, no frames can be sent. Pacing the transport of subsequent frames on the basis of this credit system helps prevent the loss of frames and reduces the frequency of entire Fibre Channel sequences needing to be retransmitted across the link.

Because the number of buffer credits available for use within each port group is limited, configuring buffer credits for extended links may affect the performance of the other ports in the group used for core-to-edge connections. You must balance the number of long-distance ISL connections and core-to-edge ISL connections within a switch.

---

### NOTE

Configuring long-distance ISLs between core and edge switches is possible, but is not a recommended practice.

---

All switch ports provide protection against buffer depletion through buffer limiting. A buffer-limited port reserves a minimum of eight buffer credits, allowing the port to continue to operate rather than being disabled due to a lack of buffers.

Buffer-limited operations are supported for the LS and LD extended ISL modes only. For LD, distance in kilometers is the smaller of the distance measured during port initialization versus the desired distance value. For LS, distance in kilometers is always the desired distance value.

## Buffer-to-buffer flow control

Buffer-to-buffer (BB) credit flow control is implemented to limit the amount of data that a port may send based on the number and size of the frames sent from that port. Buffer credits represent finite physical port memory. Within a fabric, each port may have a different number of BB credits. Within a connection, each side may have a different number of BB credits.

Buffer-to-buffer flow control is flow control between adjacent ports in the I/O path, for example, transmission control over individual network links. A separate, independent pool of credits is used to manage buffer-to-buffer flow control. Buffer-to-buffer flow control works by a sending port using its available credit supply and waiting to have the credits replenished by the port on the opposite end of the link. These BB credits are used by Class 2 and Class 3 service and rely on the Fibre Channel Receiver-Ready (R\_RDY) control word to be sent by the receiving link port to the sender. The rate of frame transmission is regulated by the receiving port based on the availability of buffers to hold received frames.

Upon arrival at a receiver, a frame goes through several steps. It is received, deserialized, decoded, and is stored in a receive buffer where it is processed by the receiving port. If another frame arrives while the receiver is processing the first frame, a second receive buffer is needed to hold this new frame. Unless the receiver is capable of processing frames as fast as the transmitter is capable of sending them, it is possible for all of the receive buffers to fill up with received frames. At this point, if the transmitter should send another frame, the receiver will not have a receive buffer available and the frame is lost. Buffer-to-Buffer flow control provides consistent and reliable frame delivery of information from sender to receiver.

## Optimal buffer credit allocation

The optimal number of buffer credits is determined by the distance (frame delivery time), the processing time at the receiving port, link signaling rate, and size of the frames being transmitted. As the link speed increases, the frame transmission time is reduced and the number of buffer credits must be increased to obtain full link utilization, even in a short-distance environment.

For each frame that is transferred, the hardware at the other end must acknowledge that the frame has been received before a successful transmission occurs. This requires enough capacity in the hardware to allow continuous transmission of frames on the link, while waiting for the acknowledgement to be sent by the receiver at the other end.

As the distance between switches and the link speed increases, additional buffer credits are required for the ports used for long-distance connections. Distance levels define how buffer credits are allocated and managed for extended ISLs. Buffer credits are managed from a common pool available to a group of ports on a switch. The buffer credit can be changed for specific applications or operating environments, but it must be in agreement among all switches to allow formation of the fabric.

To maintain 100 percent utilization of a 1 Gbps link for 100 km, the sending hardware must have enough resources (BB credits) to keep 106,250 bytes on the link and the receiving hardware must have enough resources to allow the sender to transmit continuously. To theoretically achieve 100 percent utilization of a 2 Gbps link for 100 km, the required number of BB credits ranges from 98 to 2310 depending on the average frame size. When the link speed is increased to 4 Gbps, the required number of BB credits ranges from 196 to 4620. It is not possible for the switch to determine what the frame size is going to be.

### *Considerations for calculating buffer credits*

Following are the considerations for calculating how many ports can be configured for long distance on all Fabric OS v7.x-capable switch modules:

- Each port is part of a port group that includes a pool of buffer credits that can be utilized. This is not the same as the port groups used for ISL Trunking.
- Each user port reserves eight buffer credits when online or offline.
- Any remaining buffers can be reserved by any port in the port group.
- When QoS is enabled and the port is online, an additional 20 buffers are allocated to that port.
- The FR4-18i blade has a limitation of 255 buffers maximum that can be allocated to a port, which corresponds to a distance of ~500 km at 1 Gbps.

## Fibre Channel gigabit values reference definition

Before you can calculate the buffer requirement, note the following Fibre Channel gigabit values reference definition:

- 1.0625 for 1 Gbps
- 2.125 for 2 Gbps
- 4.25 for 4 Gbps
- 8.5 for 8 Gbps
- 10.625 for 10 Gbps
- 17 for 16 Gbps

## Allocating buffer credits based on full-size frames

Assuming that the frame size is full, one buffer credit allows a device to send one payload up to 2112 bytes (2148 with headers). Assuming that each payload is 2112, you need one credit per 1 km of link length at 2 Gbps (smaller payloads require additional BB credits to maintain link utilization). See [“Allocating buffer credits based on average-size frames”](#) on page 459 for additional information.

The final frame size must be a multiple of 4 bytes. If the data (payload) needs to segment, it will be padded with 1 to 3 “fill-bytes” to achieve an overall 4-byte frame alignment. The standard frame header size is 24 bytes. If applications require extensive control information, up to 64 additional bytes (for a total of an 88-byte header) can be included. Because the total frame size cannot exceed the maximum of 2,148 bytes, the additional header bytes will subtract from the data segment size by as much as 64 bytes (per frame). This is why the maximum data (payload) size is 2,112 (because  $[2,112 - 64] = 2,048$ , which is 2 kbs of data). The final frame, after it is constructed, is passed through the 8-byte to 10-byte conversion process.

[Table 78](#) describes Fibre Channel data frames.

**TABLE 78** Fibre Channel data frames

Fibre Channel Frame fields	Field size	
Start of frame	4 bytes	32 bits
Standard frame header	24 bytes	192 bits
Data (payload)	0 - 2,112 bytes	0 - 16,896 bits
CRC	4 bytes	32 bits
End of frame	4 bytes	32 bits
<b>Total (Number bits/frame)</b>	<b>36 - 2,148 bytes</b>	<b>288 - 17,184 bits</b>

You can allocate buffer credits based on distance using the `portCfgLongDistance` command. The long distance link modes allow you to select the Dynamic mode (LD) or the Static Long-distance mode (LS) to calculate the BB credits.

For LD, the estimated distance in kilometers is the smaller of the distance measured during port initialization versus the *desired\_distance parameter*, which is required when a port is configured as an LD or an LS mode link. It is best practice to use LS over LD. The assumption of Fibre Channel

payloads consistently being 2,112 bytes is not realistic in practice. To gain the proper number of BB credits using the LS mode, there must be enough BB credits available in the pool because Fabric OS will check before accepting a value.

---

**NOTE**

The **portCfgLongDistance** command's *desired\_distance* parameter is the upper limit of the link distance and is used to calculate buffer availability for other ports in the same port group. When the measured distance exceeds the value of *desired\_distance*, this value is used to allocate the buffers. In this case, the port operates in degraded mode instead of being disabled due to insufficient buffers. In LS mode, the actual link distance is not measured; instead, the *desired\_distance* value is used to allocate the buffers required for the port.

---

Refer to the data in [Table 79](#) on page 461 and [Table 80](#) on page 462 to get the total ports in a switch or blade, number of user ports in a port group, and the unreserved buffer credits available per port group. The values reflect an estimate, and may differ from the supported values in [Table 80](#).

1. Determine the desired distance in kilometers of the switch-to-switch connection. This example uses 50 km.
2. Determine the speed that you will use for the long-distance connection. This example uses 2 Gbps.
3. Use one of the following formulas to calculate the reserved buffers for distance:

- If QoS is enabled:

$$(\text{Reserved Buffer for Distance } Y) = (X * \text{LinkSpeed} / 2) + 6 + 14$$

- If QoS is not enabled:

$$(\text{Reserved Buffer for Distance } Y) = (X * \text{LinkSpeed} / 2) + 6$$

Where:

X = the distance determined in step 1 (in kilometers).

LinkSpeed = the speed of the link determined in step 2.

6 = the number of buffer credits reserved for Fabric Services, Multicast, and Broadcast traffic. This is a static number.

14 = the number of buffer credits reserved for QoS. This is a static number.

Based on the answers provided in steps 1 and 2, insert the numbers into the formula. The formula should read as follows:

$$(50 \text{ km} * 2 \text{ Gbps} / 2) + 6 = 56 \text{ buffers, which is the number of buffers reserved for distance}$$

Below are additional examples using different speeds all based on a distance of 50 km. The distances and speeds are variables that can change based on how your network is set up:

- If you have a distance of 50 km at 1 Gbps then,  $(50 \text{ km} * 1 \text{ Gbps} / 2) + 6 = 31$  buffers
- If you have a distance of 50 km at 2 Gbps then,  $(50 \text{ km} * 2 \text{ Gbps} / 2) + 6 = 56$  buffers
- If you have a distance of 50 km at 4 Gbps then,  $(50 \text{ km} * 4 \text{ Gbps} / 2) + 6 = 106$  buffers
- If you have a distance of 50 km at 8 Gbps then,  $(50 \text{ km} * 8 \text{ Gbps} / 2) + 6 = 206$  buffers
- If you have a distance of 50 km at 10 Gbps then,  $(50 \text{ km} * 10 \text{ Gbps} / 2) + 6 = 256$  buffers
- If you have a distance of 50 km at 16 Gbps then,  $(50 \text{ km} * 16 \text{ Gbps} / 2) + 6 = 406$  buffers



**Example**

Consider the Brocade 300, which has a single 24-port port group and a total of 676 buffer credits for that port group. The maximum remaining number of buffer credits for the port group, after each port reserves its eight buffer credits, is:

$$676 - (24 * 8) = 484 \text{ unreserved buffer credits}$$

Where:

24 = the number of user ports in a port group retrieved from [Table 79](#) on page 461.

8 = the number of reserved credits for each user port.

676 = the number of buffer credits available in the port group.

If you allocate the entire 484 + 8 (8 for the reserved buffers already allocated to that user port) = 492 buffers to a single port, you can calculate the maximum single port extended distance supported:

$$[\text{Maximum Distance X in km}] = (\text{BufferCredits} + 6) * 2 / \text{LinkSpeed}$$

$$498 \text{ km} = (492 + 6 \text{ buffers for Fabric Services}) * 2 / 2 \text{ Gbps}$$

How many 50 km ports can you configure?

If you have a distance of 50 km at 8 Gbps then,  $484 / (206 - 8) = 2$  ports

The numbers used are: 484, which equals the total number of unreserved buffer credits, 206, which equals buffer credits needed for 50 km @ 8 Gbps (calculated previously), and 8, which equals number of reserved buffer credits already allocated to that port. The floor of the resulting number is taken because fractions of a port are not allowed.

If you have a distance of 50 km at 1 Gbps then,  $484 / (31 - 8) = 21$  ports

**Allocating buffer credits based on average-size frames**

In cases where the frame size is average, for example 1024 bytes, you must allocate twice the buffer credits or give twice the distance in the long-distance LS configuration mode. Refer to [“Fibre Channel gigabit values reference definition”](#) on page 457 to get an approximation of the calculated number of buffer credits.

1. Use the following formula to calculate value for the *desired\_distance* needed for Fabric OS to determine the number of BB credits to allocate:

$$\text{desired\_distance} = \text{roundup} [(\text{real\_estimated\_distance} * 2112) / \text{average\_payload\_size}]$$

Where *average\_payload\_size* = 1024 bytes

This example uses 100 km for the real estimated distance.

$$\text{desired\_distance} = \text{roundup} [(100 * 2112) / 1024] = 207$$

When configuring the LS mode with the **portCfgLongDistance** command, enter a *desired\_distance* value of 207 for an actual 100 km link connected to an 8 Gbps E\_Port. This causes Fabric OS to allocate the correct number of BB credits.

2. Determine the speed you will use for the long-distance connection. This example uses 8 Gbps.
3. Look up the *data\_rate* value for the speed of the connection. See [“Fibre Channel gigabit values reference definition”](#) on page 457 to determine the *data\_rate* value.

For 8 Gbps, the *data\_rate* is 8.5

- Use the following formula to calculate the number of buffer-to-buffer credits to allocate:

$$BB \text{ credits} = \text{roundup} [ \text{desired\_distance} * (\text{data\_rate} / 2.125) ]$$

Using the values for *desired\_distance* and *data\_rate* from [step 1](#) and [step 3](#), the value for BB credits is calculated as follows:

$$BB \text{ credits} = \text{roundup} [(207 * 8.5) / 2.125] = 828$$

---

**NOTE**

This formula does not work with LD mode because LD mode checks the distance and limits the estimated distance to the real value of 100 km. LS mode allows for the necessary *desired\_distance* based on the data size entered, regardless of the distance.

---

If buffer credit recovery is enabled, Fabric OS supports a BB\_SC\_N range of 1 to 15; therefore, it is impossible for the *desired\_distance* to be more than the number of BB credits available in the pool as determined by the calculations above. The BB credit recovery supported distance is well within the range of all possible connections. An estimated distance of 32,768 is considerably higher than the available BB credits and only lower values of *desired\_distance* are permitted by Fabric OS.

## Allocating buffer credits for F\_Ports

The default configured F\_Port buffer credit is fixed at eight buffers. You can use the **portCfgFPortBuffers** command to configure a given port with the specified number of buffers. Note that in the sample commands provided in the following procedure, 12 buffers are configured for an F\_Port.

- Connect to the switch and log in using an account assigned to the admin role.
- Enter the **portCfgFPortBuffers** command.

```
switch:admin> portcfgfportbuffers --enable 2/44 12
```

To disable the port buffer configuration and return to the default buffer allocation:

```
switch:admin> portcfgfportbuffers --disable 2/44
```

---

**NOTE**

The configured number of buffers for the given port is stored in the configuration database and is persistent across reboots. The F\_Port buffer feature does not support EX\_Port, Port Mirroring, Long-Distance, L\_Port, Fast Write, QoS, and Trunk Area enabled ports.

---

## Displaying the remaining buffers in a port group

- Connect to the switch and log in using an account assigned to the admin role.
- Enter the **portBufferShow** command.

```
switch:admin> portbuffershow 17
```

User Port	Port Type	Lx Mode	Max/Resv Buffers	Buffer Usage	Needed Buffers	Link Distance	Remaining Buffers
16		-	-	0	-	-	
17	E	L1	-	54	54	50km	
18		-	-	0	-	-	
19		-	-	0	-	-	54

## Buffer credits for each switch model

Table 79 shows the total ports in a switch or blade, number of user ports in a port group, and the unreserved buffer credits available per port group. The number in the **Unreserved buffers** column is the number with QoS enabled. This number is higher if QoS is not enabled.

**TABLE 79** Buffer credits

Switch/blade model	Total FC ports (per switch/blade)	User port group size	Unreserved buffers (per port group) with QoS enabled
300	24	24	484
5100	40	40	1692
5300	80	16	292
5410	12	12	580
5424	24	24	484
5450	26	26	468
5480	24	24	484
6505	24	24	7424
6510	48	48	6752
7800	16	16	408
8000	*** Extended Fabrics is not supported on this switch ***		
VA-40FC	40	40	1692
Brocade Encryption Switch	32	16	1392
FC8-16	16	16	1292/ 508
FC8-32	32	16	1292/ 508
FC8-32E	32	16	5188
FC8-48	48	24	1228/ 716
FC8-48E	48	24	4484
FC8-64	*** Extended Fabrics is not supported on this blade ***		
FC16-32	32	16	5188
FC16-48	48	24	4484
FR4-18i	16	8	377
FS8-18	16	8	1604
FX8-24	12	12	1060

For the FC8-x port blades, the first number in the Unreserved buffers column designates the number of unreserved buffers per port group without buffer optimized mode; the second number designates the unreserved buffers with buffer optimized mode enabled on the slot. Use the **bufOpMode** command to display or change the buffer optimized mode.

## Maximum configurable distances for Extended Fabrics

Table 80 shows the maximum supported extended distances (in kilometers) that can be configured for one port on a specific switch or blade at different speeds.

**TABLE 80** Configurable distances for Extended Fabrics

Maximum distances (km) that can be configured assuming 2112 Byte Frame Size					
Switch/blade model	2 Gbps	4 Gbps	8 Gbps	10 Gbps	16 Gbps
300	486	243	121	N/A	N/A
5100	1694	847	423	N/A	N/A
5300	294	147	73	N/A	N/A
5410	582	291	145.5	N/A	N/A
5424	486	243	121.5	N/A	N/A
5450	470	235	117.5	N/A	N/A
5480	486	243	121.5	N/A	N/A
6505	7904	3952	1976	1580	988
6510	7712	3856	1928	1542	964
7800	410	205	102	N/A	N/A
8000	*** Extended Fabrics is not supported on this switch ***				
VA-40FC	1694	847	423	N/A	N/A
Brocade Encryption Switch	1392	696	348	N/A	N/A
FC8-16	1294	647	323	N/A	N/A
FC8-32	1294	647	323	N/A	N/A
FC8-32E	5508	2754	1377	1101	688
FC8-48	1230	615	307	N/A	N/A
FC8-48E	4964	2482	1241	992	620
FC8-64	*** Extended Fabrics is not supported on this blade ***				
FC16-32	5508	2754	1377	1101	688
FC16-48	4964	2482	1241	992	620
FC10-6	See the Note at the end of this table for information about this blade.				
FR4-18i	250	100	N/A	N/A	N/A
FS8-18	1604	802	401	N/A	N/A
FX8-24	1062	531	265	N/A	N/A

### NOTE

The 10 Gbps FC10-6 blade has two port groups of three ports each. For extended ISLs, all buffers available to a group are used to support one port at up to 100 km.

### NOTE

QoS requires an additional 20 buffer credits per active port so maximum supported distances may be lower.

To get an estimated maximum equally distributed distance for  $n$  number of ports at a particular ("X") speed, divide the 1-port maximum distance of the switch at X speed by  $n$ . For example, for three ports running at 2 Gbps on a 300 switch, the maximum equally distributed distance is calculated as  $486 / 3 = 162$  km.

## Buffer credit recovery

Buffer credit recovery does not require configuration. This feature allows links to recover after R\_RDYs are lost when the credit recovery logic is enabled. The buffer credit recovery feature also maintains performance. If a credit is lost, a recover attempt is initiated. During link reset, the frame and credit loss counters are reset without performance degradation.

This feature is only supported on E\_Ports that are configured for long distance and are connected between the following switch or blade models:

- Brocade 300, 5100, 5300, 5410, 5424, 5450, 5480, 6505, 6510, VA-40FC
- FC8-16, FC8-32, FC8-32E, FC8-48, FC8-48E, FC16-32, FC16-48

If a long-distance E\_Port from one of these supported switches or blades is connected to any other switch or blade type, the buffer credit recovery feature is disabled.

VE\_Ports and VEX\_Ports do not support the **portCfgFportBuffers** or **portCfgLongDistance** commands. The buffer credit recovery feature is enabled for the following flow control modes: Normal, Virtual Channel (VC), and Extended VC modes.

An FC\_Port that supports BB\_Credit recovery maintains the following BB\_Credit recovery values:

- BB\_SC\_N is the log2 of BB\_Credit recovery modules.
- BB\_RDY\_N counts the number of R\_RDY primitives received modulo  $2BB\_SC\_N$ .
- BB\_FRM\_N counts the number of frames received modulo  $2BB\_SC\_N$ .



# Using FC-FC Routing to Connect Fabrics

---

## In this chapter

- FC-FC routing overview . . . . . 465
- Fibre Channel routing concepts . . . . . 468
- Setting up FC-FC routing . . . . . 475
- Backbone fabric IDs . . . . . 477
- FCIP tunnel configuration . . . . . 478
- Inter-fabric link configuration . . . . . 478
- FC router port cost configuration . . . . . 482
- EX\_Port frame trunking configuration . . . . . 484
- LSAN zone configuration . . . . . 485
- Proxy PID configuration . . . . . 498
- Fabric parameter considerations . . . . . 498
- Inter-fabric broadcast frames . . . . . 499
- Resource monitoring . . . . . 500
- FC-FC routing and Virtual Fabrics . . . . . 501
- Upgrade and downgrade considerations for FC-FC routing . . . . . 504
- Displaying the range of output ports connected to xlate domains . . . . . 505

## FC-FC routing overview

The FC-FC routing service provides Fibre Channel routing between two or more fabrics without merging those fabrics. For example, using FC-FC routing, you can share tape drives across multiple fabrics without the administrative problems, such as change management, network management, scalability, reliability, availability, and serviceability, that might result from merging the fabrics.

Note the different routing terminologies:

- *FC routing* is only in a single fabric (Layer 2 routing). This type of routing is discussed in [Chapter 4, “Routing Traffic”](#).
- *FC-FC routing* is routing between two fabrics (Layer 3 routing) and is discussed in this chapter.

FC-FC routing supports connectivity between the following types of fabrics:

- Fabric OS and Fabric OS
- Fabric OS and Brocade Network OS
- Fabric OS and M-EOS

For more information about M-EOS connectivity, refer to [Appendix A, “Interoperation of Fabric OS and M-EOS Fabrics Using FC Router”](#).

A Fibre Channel router (FC router) is a switch running the FC-FC routing service. The FC-FC routing service can be simultaneously used as an FC router and as a SAN extension over wide area networks (WANs) using FCIP.

You can set up QoS traffic prioritization over FC routers. Refer to [“QoS: SID/DID traffic prioritization”](#) on page 419 for information about QoS and instructions for setting traffic prioritization over an FC router.

### License requirements for FC-FC routing

The Integrated Routing license is required for FC-FC routing between Fabric OS fabrics and between Fabric OS and M-EOS fabrics.

---

#### NOTE

The Integrated Routing license is *not* required for connectivity between Fabric OS and Brocade Network OS fabrics or between Brocade Network OS fabrics connected by an FC router.

---

The Integrated Routing license allows 8-Gbps and 16-Gbps FC ports to be configured as EX\_Ports (or VEX\_Ports) supporting FC-FC routing.

Enabling the Integrated Routing license and capability does *not* require a switch reboot.

---

#### NOTE

Brocade recommends that all FC routers in a backbone fabric either have the Integrated Routing license or not. It is not recommended to mix licensed and unlicensed FC routers in the backbone fabric.

---

### Supported platforms for FC-FC routing

FC-FC routing is supported on the following platforms:

- Brocade DCX and DCX 8510 Backbone families:
  - 8-Gbps port blades (FC8-16, FC8-32, FC8-32E, FC8-48, FC8-48E, FC8-64)
  - 16-Gbps port blades (FC16-32, FC16-48)
  - FX8-24 DCX Extension Blade
  - FR4-18i Router Blade (Brocade DCX Backbone family only, and only VEX\_Ports)
- Brocade 5100 switch
- Brocade 5300 switch
- Brocade 6510 switch
- Brocade VA-40FC switch
- Brocade 7800 Extension Switch
- Brocade Encryption Switch

For the Brocade Backbone families, note the following restrictions:

- EX\_Ports and VEX\_Ports are supported only on the FX8-24 DCX Extension Blade, and the 8-Gbps and 16-Gbps *port* blades. Ports on the *core* blade cannot be configured as EX\_Ports.



- VEX\_Ports are supported on the FR4-18i Router Blade, but EX\_Ports are not supported. The FR4-18i blade is not supported in the same chassis as the FX8-24 blade.
- The Backbones have a limit of 128 EX\_Ports for each chassis.

Refer to the *Network OS Administrator's Guide* for supported Network OS platforms.

## Supported configurations for FC-FC routing

FC-FC routing supports the following configurations:

- FC router connected to a Fabric OS nonsecured edge fabric.
- FC router connected to a Fabric OS secured edge fabric.
- FC router connected to a Brocade Network OS edge fabric (Network OS v2.1.1 or later).
- FC router connected to an M-EOS Open Mode edge fabric.
- FC router connected to an M-EOS Fabric Mode edge fabric.
- FC router interoperating with legacy FC routers (Brocade 7500 switch or FR4-18i blade).

In configurations with two backbone fabrics connected to the same edge fabric, routing is not supported between edge fabrics that are not directly attached to the same backbone fabric. Routing over multiple backbone fabrics is a multi-hop topology and is not allowed.

In an edge fabric that contains a mix of administrative domain (AD)-capable switches and switches that are not aware of AD, the FC router must be connected directly to an AD-capable switch. For more information, refer to [“Use of Admin Domains with LSAN zones and FC-FC routing”](#) on page 485.

VEX edge to VEX edge device sharing is not supported.

## Unsupported configurations for Network OS connectivity

Note the following configuration limitations for Network OS connectivity:

- All of the platforms listed in [“Supported platforms for FC-FC routing”](#) on page 466 support FC-FC routing to a Brocade Network OS fabric, except for the following:
  - Brocade Encryption Switch
  - FR4-18i Router Blade
- VEX\_Ports do not support Network OS connectivity.
- FCoE devices connected to a Brocade 8000 switch or FCOE10-24 blade cannot communicate with FCoE devices in the Network OS fabric.
- If Admin Domains are enabled, connectivity between the Fabric OS fabric and a Brocade Network OS fabric is not supported.
- Connectivity between a Brocade Network OS fabric and an M-EOS fabric is not supported.

## Fibre Channel routing concepts

Fibre Channel routing introduces the following concepts:

- Fibre Channel router (FC router)

A switch running the FC-FC routing service. Refer to “[Supported platforms for FC-FC routing](#)” on page 466 for a list of platforms that can be FC routers.

- EX\_Port and VEX\_Port

An EX\_Port and VEX\_Port function similarly to an E\_Port and VE\_Port respectively, but terminate at the switch and do not propagate fabric services or routing topology information from one edge fabric to another. Refer to the *Fibre Channel over IP Administrator’s Guide* for details about VE\_Ports.

- Edge fabric

An edge fabric is a Fibre Channel fabric with targets and initiators connected through the supported platforms by using an EX\_Port or VEX\_Port.

- Backbone fabric

A backbone fabric is an intermediate network that connects one or more edge fabrics. In a SAN, the backbone fabric consists of at least one FC router and possibly a number of Fabric OS-based Fibre Channel switches (refer to [Figure 74](#) on page 471).

- Inter-fabric link (IFL)

The link between an E\_Port and EX\_Port, or VE\_Port and VEX\_Port, is called an *inter-fabric link* (IFL). You can configure multiple IFLs from an FC router to an edge fabric.

[Figure 72](#) shows a metaSAN consisting of three edge fabrics connected through a Brocade DCX with inter-fabric links.

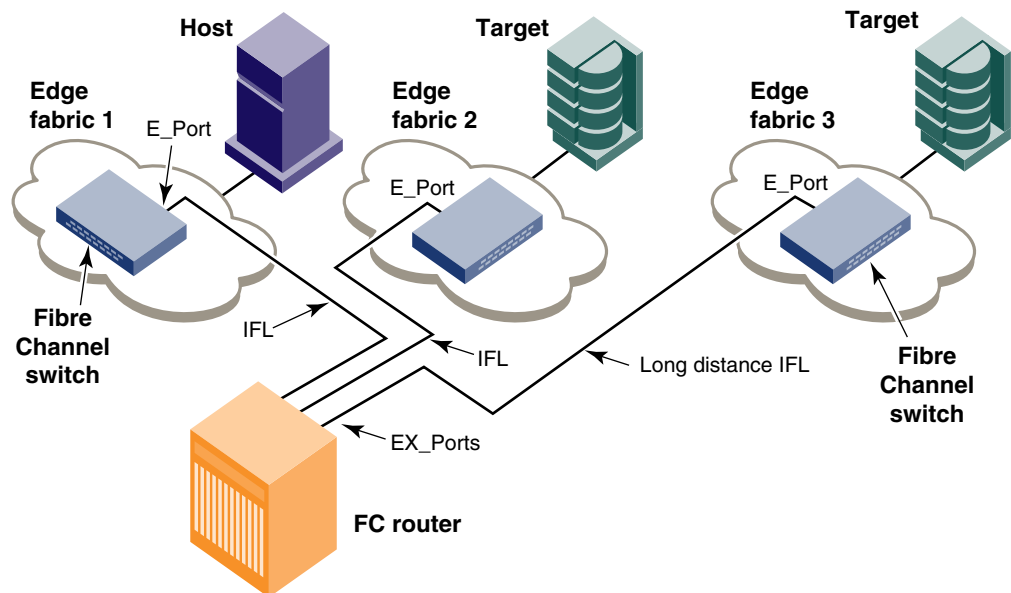

FIGURE 72 A metaSAN with inter-fabric links

- Logical SANs (LSANs)

An LSAN is defined by zones in two or more edge or backbone fabrics that contain the same devices. You can create LSANs that span fabrics. These LSANs enable Fibre Channel zones to cross physical SAN boundaries without merging the fabrics while maintaining the access controls of zones.

An LSAN device can be a *physical device*, meaning that it physically exists in the fabric, or it can be a *proxy device*.

Figure 73 shows a metaSAN with a backbone consisting of one FC router connecting hosts in edge fabrics 1 and 3 with storage in edge fabric 2 and the backbone fabric through the use of LSANs. Three LSAN zones allow device sharing between the backbone fabric and edge fabric 1, between edge fabric 1 and edge fabric 2, and between edge fabric 2 and edge fabric 3.

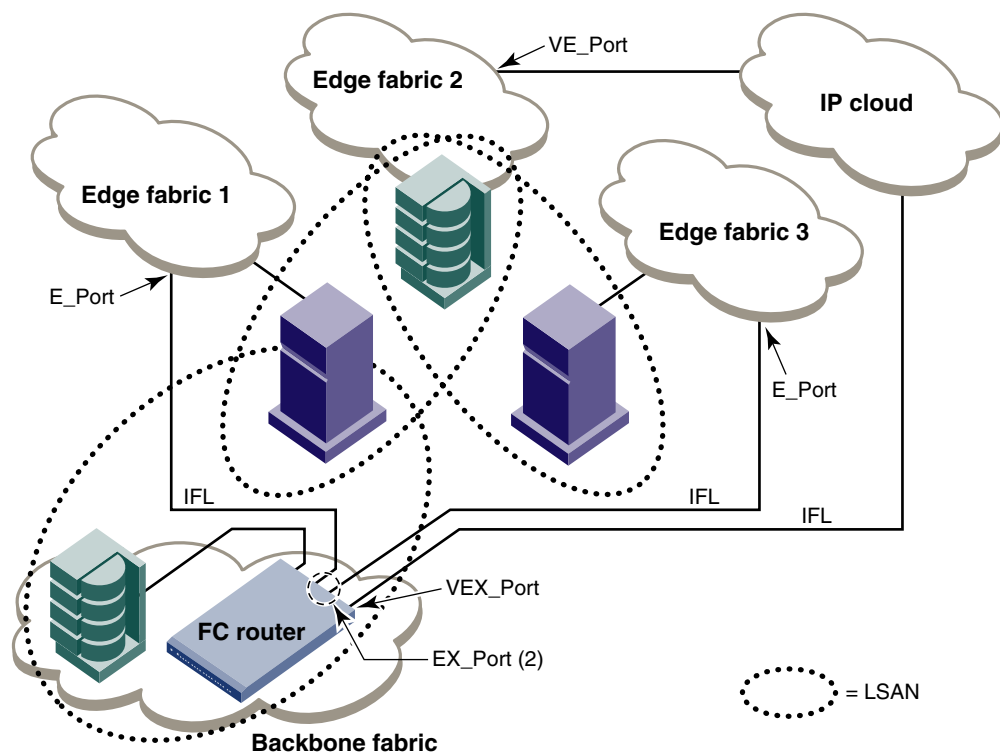

FIGURE 73 A metaSAN with edge-to-edge and backbone fabrics and LSAN zones

- Proxy device

A proxy device is a virtual device imported into a fabric by a Fibre Channel router, and represents a real device on another fabric. It has a name server entry and is assigned a valid port ID. When a proxy device is created in a fabric, the real Fibre Channel device is considered to be imported into this fabric. The presence of a proxy device is required for inter-fabric device communication. Refer to “Proxy devices” on page 471 for additional information about proxy devices.

- Proxy PID

A proxy PID is the port ID (PID) of the proxy device. The proxy device appears to the fabric as a real Fibre Channel device, has a name server entry, and is assigned a valid port ID. The port ID is relevant only on the fabric in which the proxy device has been created.

- Fabric ID (FID)

Every EX\_Port and VEX\_Port uses the fabric ID (FID) to identify the fabric at the opposite end of the inter-fabric link. The FID for every edge fabric must be unique from the perspective of each backbone fabric.

- If multiple EX\_Ports (or multiple VEX\_Ports) are attached to the same edge fabric, they must be configured with the same FID.
- If EX\_Ports and VEX\_Ports are attached to different edge fabrics, they must be configured with a unique FID for each edge fabric.

If two different backbone fabrics are connected to the same edge fabric, the backbone fabric IDs must be different, but the edge fabric IDs must be the same. If you configure the same fabric ID for two backbone fabrics that are connected to the same edge fabric, a RASLog message displays a warning about fabric ID overlap.

---

**NOTE**

Backbone fabrics that share connections to the same edge fabrics must have unique backbone fabric IDs.

---

- MetaSAN

A metaSAN is the collection of all SANs interconnected with Fibre Channel routers.

A simple metaSAN can be constructed using an FC router to connect two or more separate fabrics. Additional FC routers can be used to increase the available bandwidth between fabrics and to provide redundancy.

[Figure 74](#) shows a metaSAN consisting of a host in Edge SAN 1 connected to storage in Edge SAN 2 through a backbone fabric connecting two FC routers.

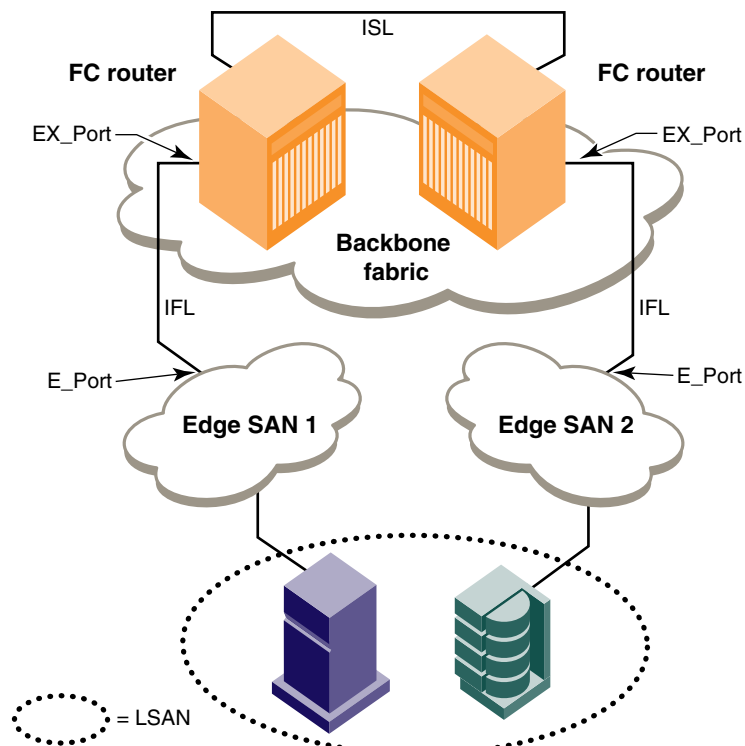

**FIGURE 74** Edge SANs connected through a backbone fabric

- Phantom domains

A phantom domain is a domain emulated by the Fibre Channel router. The FC router can emulate two types of phantom domains: front phantom domains and translate phantom domains. For detailed information about phantom domains, refer to [“Phantom domains”](#) on page 473.

## Proxy devices

An FC router achieves inter-fabric device connectivity by creating proxy devices (hosts and targets) in attached fabrics that represent real devices in other fabrics. For example, a host in Fabric 1 can communicate with a target in Fabric 2 as follows:

- A proxy target in Fabric 1 represents the real target in Fabric 2.
- Likewise, a proxy host in Fabric 2 represents the real host in Fabric 1.

The host discovers and sends Fibre Channel frames to the proxy target. The FC router receives these frames, translates them appropriately, and then delivers them to the destination fabric for delivery to the target.

The target responds by sending frames to the proxy host. Hosts and targets are exported from the edge SAN to which they are attached and, correspondingly, imported into the edge SAN reached through Fibre Channel routing. [Figure 75](#) illustrates this concept.

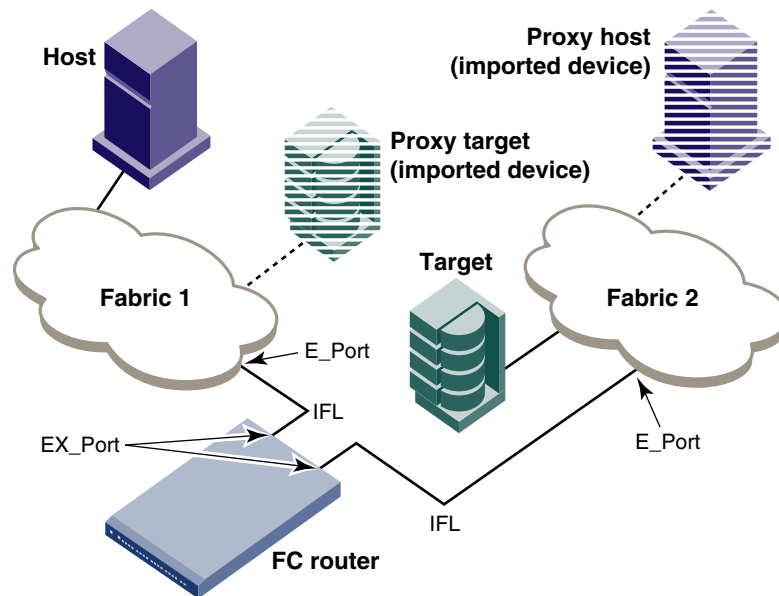

FIGURE 75 MetaSAN with imported devices

## FC-FC routing topologies

The FC-FC routing service provides two types of routing:

- Edge-to-edge

Occurs when devices in one edge fabric communicate with devices in another edge fabric through one or more FC routers.

- Backbone-to-edge

Occurs when FC routers connect to a common fabric—known as a *backbone fabric*—through E\_Ports. A backbone fabric can be used as a transport fabric that interconnects edge fabrics. FC routers also enable hosts and targets in edge fabrics to communicate with devices in the backbone fabric, known as *backbone-to-edge routing*. From the perspective of the edge fabric, the backbone fabric is like any other edge fabric. For the edge fabric and backbone fabric devices to communicate, the shared devices must be presented to each other's native fabric.

To do so, at least one translate phantom domain is created in the backbone fabric. This translate phantom domain represents the entire edge fabric. The shared physical devices in the edge have corresponding proxy devices on the translate phantom domain.

Each edge fabric has one and only one translate phantom domain to the backbone fabric. The backbone fabric device communicates with the proxy devices whenever it needs to contact the shared physical devices in the edge. The FC-FC routing service receives the frames from the backbone switches destined to the proxy devices, and redirects the frames to the actual physical devices. When connected to edge fabrics, the translate phantom domain can never be the principal switch of the backbone fabric. Front domains are not created; rather, only translate phantom domains are created in the backbone fabric.

Devices are exported from the backbone fabric to one or more edge fabrics using LSANs. Refer to [“LSAN zone configuration”](#) on page 485 for more information.

## Phantom domains

A phantom domain is a domain created by the Fibre Channel router. The FC router creates two types of phantom domains: front phantom domains and translate phantom domains.

A *front phantom domain*, or *front domain*, is a domain that is projected from the FC router to the edge fabric. There is one front phantom domain from each FC router to an edge fabric, regardless of the number of EX\_Ports connected from that router to the edge fabric. Another FC router connected to the same edge fabric projects a different front phantom domain.

A *translate phantom domain*, also referred to as *translate domain* or *xlate domain*, is a router virtual domain that represents an entire fabric. The EX\_Ports present xlate domains in edge fabrics as being topologically behind the front domains; if the xlate domain is in a backbone fabric, then it is topologically present behind the FC router because there is no front domain in a backbone fabric.

If an FC router is attached to an edge fabric using an EX\_Port, it creates xlate domains in the fabric corresponding to the imported edge fabrics with active LSANs defined. If you import devices into the backbone fabric, then an xlate domain is created in the backbone device in addition to the one in the edge fabric.

Figure 76 shows a sample physical topology. This figure shows four FC routers in a backbone fabric and four edge fabrics connected to the FC routers.

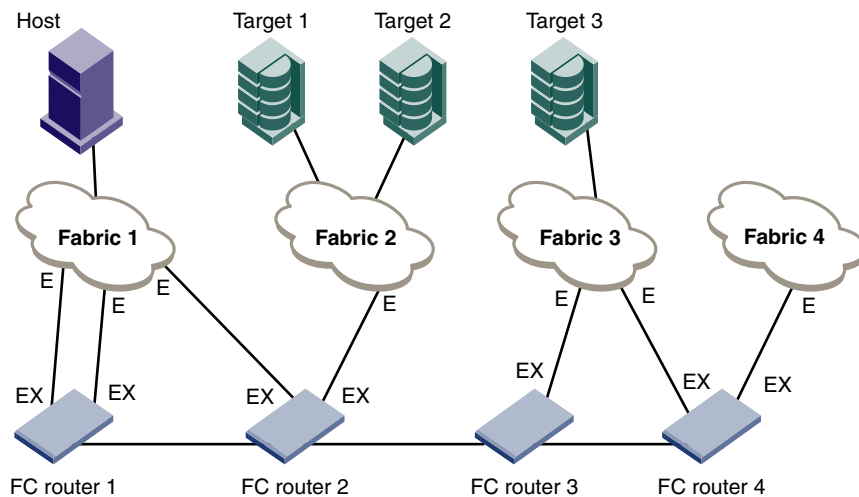

**FIGURE 76** Sample topology (physical topology)

Figure 77 shows a phantom topology for the physical topology shown in Figure 76. In this figure, the dashed lines and shapes represent the phantom topology from the perspective of Fabric 1. Fabrics 2 and 3 also see phantom topologies, but they are not shown in this example. In this figure, note the following:

- Front domain 1 and Front domain 2 are front domains for EX\_Ports connecting to Fabric 1. There is one front domain for each FC router that is connected to Fabric 1.
- Xlate domain 1 and Xlate domain 2 represent Fabrics 2 and 3, respectively. No xlate domain is created for Fabric 4 because there are no LSAN devices in Fabric 4.
- Target 1', Target 2', and Target 3' are proxy devices for Target 1, Target 2, and Target 3, respectively.

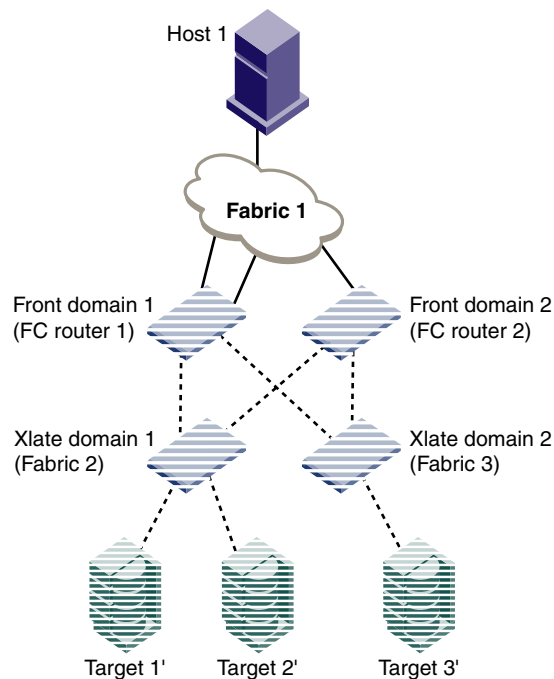

**FIGURE 77** EX\_Port phantom switch topology

All EX\_Ports or VEX\_Ports connected to an edge fabric use the same xlate domain ID for an imported edge fabric; this value persists across switch reboots and fabric reconfigurations.

If you lose connectivity to the edge fabric because of link failures or the IFL being disabled, xlate domains remain visible. This prevents unnecessary fabric disruptions caused by xlate domains repeatedly going offline and online due to corresponding IFL failures. To remove the xlate domain from the backbone, refer to [“Identifying and deleting stale xlate domains.”](#)

The combination of front domains and xlate domains allows routing around path failures, including path failures through the routers. The multiple paths to an xlate domain provide additional bandwidth and redundancy.

There are some differences in how the xlate domain is presented in the backbone fabric. The backbone xlate domains are topologically connected to FC routers and participate in FC-FC routing protocol in the backbone fabric. Front domains are not needed in the backbone fabric. As in the case of an xlate domain in an edge fabric, backbone fabric xlate domains provide additional bandwidth and redundancy by being able to present themselves as connected to single or multiple FC routers with each FC router capable of connecting multiple IFLs to edge fabrics.

Use the `fcrXlateConfig` command to display or assign a preferred domain ID to a translate domain or, in some scenarios, to prevent the creation of an unnecessary xlate domain. Refer to the *Fabric OS Command Reference* for more details about this command.

### *Identifying and deleting stale xlate domains*

If a remote edge fabric goes unreachable, the xlate domains created in other edge fabrics for this remote edge fabric are retained and not removed unless there is any disruption in the local edge fabric.

You can use the `fcrXlateConfig` command to identify and remove these stale xlate domains without disrupting the fabric.



1. Connect to the FC router and log in using an account with admin permissions.
2. Enter the `forXlateConfig --show` command to identify any stale xlate domains.
3. Enter the `forXlateConfig --del` command to delete the stale xlate domains.

#### Example

```
sw0:root> forxlateconfig --show stalexd
Imported FID      Stale XD      Owner Domain
-----
      012          002          007 ( this FCR )
sw0:root> forxlateconfig --del stalexd 12 2
Xlate domain 2 is deleted
```

## Setting up FC-FC routing

To set up FC-FC routing, perform the following tasks in the order listed.

1. Verify that you have the proper setup for FC-FC routing. (Refer to [“Verifying the setup for FC-FC routing”](#) on page 475.)
2. Assign backbone fabric IDs. (Refer to [“Backbone fabric IDs”](#) on page 477.)
3. Configure FCIP tunnels if you are connecting Fibre Channel SANs over IP-based networks. (Refer to [“FCIP tunnel configuration”](#) on page 478.)
4. Configure IFLs for edge and backbone fabric connection. (Refer to [“Inter-fabric link configuration”](#) on page 478.)
5. Modify port cost for EX\_Ports, if you want to change from the default settings. (Refer to [“FC router port cost configuration”](#) on page 482.)
6. Configure trunking on EX\_Ports that are connected to the same edge fabric. (Refer to [“EX\\_Port frame trunking configuration”](#) on page 484.)
7. Configure LSAN zones to enable communication between devices in different fabrics. (Refer to [“LSAN zone configuration”](#) on page 485.)

Refer to [Chapter 3, “Performing Advanced Configuration Tasks,”](#) for more details about configuration options for Brocade Backbones.

## Verifying the setup for FC-FC routing

Before configuring a fabric to connect to another fabric, you must perform the following verification checks on the FC router.

1. Log in to the switch or Backbone as admin and enter the `version` command. Verify that Fabric OS v7.0.1 is installed on the FC router as shown in the following example.

```
switch:admin> version
Kernel:      2.6.14.2
Fabric OS:   v7.0.1
Made on:     Fri Nov 18 01:15:34 2011
Flash:       Mon Nov 21 20:53:48 2011
BootProm:    1.0.9
```

- If you are configuring a Backbone, enter the **slotShow** command to verify that either the FR4-18i or FX8-24 blade is present or an 8-Gbps or 16-Gbps port blade is present. The following example shows slots 1, 2, 3, 9, 10, and 12 with 8-Gbps port blades enabled.

```
switch:admin> slotshow -m
Slot  Blade Type      ID      Model Name      Status
-----
  1     SW BLADE      37      FC8-16          ENABLED
  2     SW BLADE      37      FC8-16          ENABLED
  3     SW BLADE      37      FC8-16          ENABLED
  4     SW BLADE      39      FC10-6          ENABLED
  5     CORE BLADE    52      CORE8           ENABLED
  6     CP BLADE      50      CP8             ENABLED
  7     CP BLADE      50      CP8             ENABLED
  8     CORE BLADE    52      CORE8           ENABLED
  9     SW BLADE      37      FC8-16          ENABLED
 10     SW BLADE      55      FC8-32          ENABLED
 11     UNKNOWN
 12     SW BLADE      51      FC8-48          ENABLED
```

Refer to [Chapter 3, “Performing Advanced Configuration Tasks,”](#) for a list of blades and their corresponding IDs.

- Enter the **licenseShow** command to verify that the Integrated Routing license is installed.

```
switch:admin> licenseshow
S9bddb9SQbTAceeC:
    Fabric license
bzbzRcbcSc0c0SY:
    Remote Fabric license
RyeSzRScycazft0G:
    Integrated Routing license
```

If you are connecting to a Fabric OS or M-EOS fabric and the Integrated Routing license is not installed, you must install it, as described in [Chapter 18, “Administering Licensing”](#). The Integrated Routing license is not required if you are connecting to a Brocade Network OS fabric.

- Verify that the Fabric-Wide Consistency Policy is not in “strict” mode by issuing the **fdccfg --showall** command. When it is in strict mode, ACL cannot support Fibre Channel routing in the fabric.

```
switch:admin> fdccfg --showall
Local Switch Configuration for all Databases:-
DATABASE - Accept/Reject
-----
SCC - accept
DCC - accept
PWD - accept
Fabric-Wide Consistency Policy :- "SCC:S;DCC"
```

If the Fabric-Wide Consistency Policy has the letter “S” in it in the edge fabric or the backbone fabric, do not connect the edge fabric to the FC router. The letter “S” (shown in the preceding sample output) indicates the policy is strict. The fabric-wide policy must be tolerant before you can connect fabrics to the FC router. Refer to [Chapter 7, “Configuring Security Policies”](#) for information about configuring the fabric-wide consistency policy.

- For 8-Gbps platforms, delete fabric mode Top Talker monitors, if they are configured. Refer to [“Deleting all fabric mode Top Talker monitors”](#) on page 415 for instructions.

FC-FC routing and fabric mode Top Talker monitors are not concurrently supported on 8-Gbps platforms.

FC-FC routing and fabric mode Top Talker monitors are concurrently supported only on the Brocade 6510 and on the Brocade DCX Backbone family with only 16-Gbps-capable ports.

## Backbone fabric IDs

If your configuration has only one backbone fabric, then you do not need to assign a backbone fabric ID because the backbone fabric ID in this situation defaults to a value of 128. The default backbone fabric ID is 1 if Virtual Fabrics is disabled.

All switches in a backbone fabric must have the same backbone fabric ID. You can configure the backbone fabric ID using the **fcrConfigure** command. The backbone fabric ID must be unique from the perspective of every attached edge fabric. Fabric ID changes made on a switch are not propagated to other switches in the backbone fabric. Rather, the backbone fabric administrator is responsible for making sure that all switches in the backbone have the same fabric ID. Because fabric IDs are used heavily by the routing protocol between the Fibre Channel routers, using the wrong fabric ID can affect both edge-to-edge and backbone-to-edge routing.

In addition to ensuring that the backbone fabric IDs are the same within the same backbone, you must make sure that when two different backbones are connected to the same edge fabric, the backbone fabric IDs are different, but the edge fabric ID should be the same. Configuration of two backbones with the same backbone fabric ID that are connected to the same edge is invalid. In this configuration, a RASLog message displays a warning about fabric ID overlap. When two backbone fabrics are *not* connected to the same edge, they can have the same backbone fabric ID.

---

### ATTENTION

In a multi-switch backbone fabric, modification of the FID within the backbone fabric will cause disruption to local traffic.

---

## Assigning backbone fabric IDs

1. Log in to the switch or Backbone.
2. Enter the **switchDisable** command if EX\_Ports are online.
3. Enter the **fosConfig --disable fcr** command to disable the FC-FC routing service.  
The default state for the FCR is disabled.
4. Enter the **fcrConfigure** command. At the prompt, enter the fabric ID, or press **Enter** to keep the current fabric ID, which is displayed in brackets.
5. Verify the backbone fabric ID is different from that set for edge fabrics.  
Multiple FC routers attached to the same backbone fabric must have the same backbone fabric ID.
6. Enter the **fosConfig --enable fcr** command.
7. Enter the **switchEnable** command.

### Example

```
switch:admin> switchdisable
switch:admin> fosconfig --disable fcr
```

```
FC Router service is disabled

switch:admin> fcrconfigure
FC Router parameter set. <cr> to skip a parameter
Please make sure new Backbone Fabric ID does not conflict with any configured
EX-Port's Fabric ID
Backbone fabric ID: (1-128) [128]

switch:admin> fosconfig --enable fcr
FC Router service is enabled

switch:admin> switchenable
```

## FCIP tunnel configuration

The optional Fibre Channel over IP (FCIP) Tunneling Service enables you to use “tunnels” to connect instances of Fibre Channel SANs over IP-based networks to transport all Fibre Channel ISL and IFL traffic. FCIP is a prerequisite for configuring VEX\_Ports; if you are only using FC\_Ports, then there is no need to configure FCIP tunnels.

If using FCIP in your FC-FC routing configuration, you must first configure FCIP tunnels. Once a tunnel is created, it defaults to a disabled state. Then configure the VE\_Port or VEX\_Port. After the appropriate ports are configured, enable the tunnel.

---

### NOTE

FCIP tunnel configuration is applicable only to Fabric OS fabrics and does not apply to Brocade Network OS or M-EOS fabrics.

---

Refer to the *Fibre Channel over IP Administrator's Guide* for instructions on how to configure FCIP tunnels.

## Inter-fabric link configuration

Before configuring an inter-fabric link (IFL), be aware that you cannot configure both IFLs (EX\_Ports, VEX\_Ports) and ISLs (E\_Ports) from a backbone fabric to the same edge fabric.

Configuring an inter-fabric link involves disabling ports and cabling them to other fabrics, configuring those ports for their intended uses, and then enabling the ports.

To configure a 16-Gbps IFL, both the EX\_Port and the connecting E\_Port must be 16-Gbps ports.

---

### ATTENTION

To ensure that fabrics remain isolated, disable the port prior to inserting the cable. If you are configuring an EX\_Port, disable the port prior to making the connection.

---

## Configuring an IFL for both edge and backbone connections

1. On the FC router, disable the port that you are configuring as an EX\_Port (the one connected to the Fabric OS switch) by issuing the **portDisable** command.

```
switch:admin> portdisable 7/10
```

You can verify that the port has been disabled by issuing the **portShow** command for the port.

2. Configure each port that connects to an edge fabric as an EX\_Port or VEX\_Port. Note the following:
  - **portCfgVEXPort** works only on VE\_Ports.
  - **portCfgEXPort** (only on the FC ports on the FC router) commands work only on ports that are capable of FC-FC routing.

Use the **portCfgEXPort** or **portCfgVEXPort** command to:

- Enable or disable EX\_Port or VEX\_Port mode.
- Set the fabric ID (avoid using fabric IDs 1 and 128, which are the default IDs for backbone connections).
- Configure an EX\_Port to connect to a Brocade Network OS fabric (**portCfgEXPort** only).

The following example configures an EX\_Port and assigns a Fabric ID of 30 to port 10.

```
switch:admin> portcfgexport 7/10 -a 1 -f 30
switch:admin> portcfgexport 7/10
Port 7/10 info
Admin: enabled
State: NOT OK
Pid format: Not Applicable
Operate mode: Brocade Native
Edge Fabric ID: 30
Preferred Domain ID: 160
Front WWN: 50:06:06:9e:20:38:6e:1e
Fabric Parameters: Auto Negotiate
R_A_TOV: Not Applicable
E_D_TOV: Not Applicable
Authentication Type: None
DH Group: N/A
Hash Algorithm: N/A
Edge fabric's primary wwn: N/A
Edge fabric's version stamp: N/A
```

This port can now connect to another switch.

The following example configures an EX\_Port for connecting to a Brocade Network OS fabric. The **-m 5** option indicates Network OS connectivity.

```
switch:admin> portcfgexport 1/5 -a 1 -f 15 -m 5
switch:admin> portcfgexport 1/5
Port 1/5 info
Admin: enabled
State: NOT OK
Pid format: Not Applicable
Operate mode: Brocade NOS
Edge Fabric ID: 15
(output truncated)
```

For related FC-FC routing commands, refer to **fcrEdgeShow**, **fcrXlateConfig**, **fcrConfigure**, and **fcrProxyConfig** in the *Fabric OS Command Reference*.

A Fibre Channel router can interconnect multiple fabrics. EX\_Ports or VEX\_Ports attached to more than one edge fabric must configure a different fabric ID for each edge fabric.

3. (Optional) Configure FC router port cost if you want to change the default values. For information about using FC router port cost operations, refer to [“FC router port cost configuration”](#) on page 482.

4. (Optional) Set up ISL or EX\_Port trunking. For information on trunking setup, refer to [“Configuring EX\\_Port trunking”](#) on page 442.
5. Enter the **portEnable** command to enable the ports that you disabled in [step 1](#).

```
switch:admin> portenable 7/10
```

6. Physically attach ISLs from the Fibre Channel router to the edge fabric.
7. Enter the **portCfgShow** command to view ports that are persistently disabled.

FC ports on the Brocade 7800 switches and FX8-24 blades are configured as persistently disabled by default, to avoid inadvertent fabric merges when installing a new FC router.

```
switch:admin> portcfgshow 7/10
Area Number:          74
Speed Level:          AUTO
Trunk Port            OFF
Long Distance         OFF
VC Link Init          OFF
Locked L_Port         OFF
Locked G_Port         OFF
Disabled E_Port       OFF
ISL R_RDY Mode        OFF
RSCN Suppressed       OFF
Persistent Disable    OFF
NPIV capability       ON
EX Port               ON
Mirror Port           ON
FC Fastwrite          ON
```

8. After identifying such ports, enter the **portCfgPersistentEnable** command to enable the port, and then the **portCfgShow** command to verify the port is enabled.

```
switch:admin> portcfgpersistentenable 7/10
```

```
switch:admin> portcfgshow 7/10
Area Number:          74
Speed Level:          AUTO
Trunk Port            OFF
Long Distance         OFF
VC Link Init          OFF
Locked L_Port         OFF
Locked G_Port         OFF
Disabled E_Port       OFF
ISL R_RDY Mode        OFF
RSCN Suppressed       OFF
Persistent Disable    OFF
NPIV capability       ON
EX Port               ON
Mirror Port           ON
FC Fastwrite          ON
```

9. Enter either the **portCfgEXPort** or **portShow** command to verify that each port is configured correctly.

```
switch:admin> portcfgexport 7/10
```

```
Port 7/10 info
Admin: enabled
```

```

State: NOT OK
Pid format: Not Applicable
Operate mode: Brocade Native
Edge Fabric ID: 30
Preferred Domain ID: 160
Front WWN: 50:06:06:9e:20:38:6e:1e
Fabric Parameters: Auto Negotiate
R_A_TOV: Not Applicable
E_D_TOV: Not Applicable
Authentication Type: None
DH Group: N/A
Hash Algorithm: N/A
Edge fabric's primary wwn: N/A
Edge fabric's version stamp: N/A

```

```
switch:admin_06> portshow 7/10
```

```
portName:
portHealth: OFFLINE
```

```
Authentication: None
```

```

EX_Port Mode: Enabled
Fabric ID: 30
Front Phantom: state = Not OK Pref Dom ID: 160
Fabric params: R_A_TOV: 0 E_D_TOV: 0 PID fmt: auto

```

```

Authentication Type: None
Hash Algorithm: N/A
DH Group: N/A
Edge fabric's primary wwn: N/A
Edge fabric's version stamp: N/A

```

```

portDisableReason: None
portCFlags: 0x1
portFlags: 0x1 PRESENT U_PORT EX_PORT
portType: 10.0
portState: 2 Offline
portPhys: 2 No_Module
portScn: 0
port generation number: 0
portId: 014a00
portIfId: 4372080f
portWwn: 20:4a:00:60:69:e2:03:86
portWwn of device(s) connected:

```

```

Distance: normal
portSpeed: N4Gbps

```

```

LE domain: 0
FC Fastwrite: ON
Interrupts: 0 Link_failure: 0 Frjt : 0
Unknown: 0 Loss_of_sync: 0 Fbsy : 0
Lli: 0 Loss_of_sig: 2
Proc_rqrd: 0 Protocol_err: 0
Timed_out: 0 Invalid_word: 0
Rx_flushed: 0 Invalid_crc: 0
Tx_unavail: 0 Delim_err: 0
Free_buffer: 0 Address_err: 0

```

```

Overrun:          0          Lr_in:           0
Suspended:       0          Lr_out:          0
Parity_err:      0          Ols_in:          0
2_parity_err:   0          Ols_out:         0
CMI_bus_err:    0

```

Port part of other ADs: No

10. Enter the **switchShow** command to verify the EX\_Port (or VEX\_Port), edge fabric ID, and name of the edge fabric switch (containing the E\_Port or VE\_Port) are correct.
11. Enter the **fcrFabricShow** command to view any edge fabric switch names and ensure links are working as expected.

---

#### NOTE

The **fcrFabricShow** command displays the static IPv6 addresses for each FC router and each edge fabric switch connected to the EX\_Ports.

---

```

switch:admin> fcrfabricshow
FCR WWN: 10:00:00:05:1e:13:59:00, Dom ID: 2, Info: 10.32.156.52
1080::8:800:200C:1234/64,
"fcr_5300"
EX_Port FID Neighbor Switch Info (WWN, enet IP, name)
-----
7 10 10:00:00:05:1e:34:11:e5 10.32.156.33 "5300" 1080::8:8FF:FE0C:417A/64
4 116 10:00:00:05:1e:37:00:44 10.32.156.34 "5300"
FCR WWN: 10:00:00:05:1e:12:e0:00, Dom ID: 100, Info:10.32.156.50
1080::8:60F:FE0C:456A/64
"fcr_5300"
EX_Port FID Neighbor Switch Info (WWN, enet IP, name)
-----
4 95 10:00:00:05:1e:37:00:45 10.32.156.31 "5300"
FCR WWN: 10:00:00:05:1e:12:e0:00, Dom ID: 100, Info: 10.32.156.50,
"fcr_Brocade 5300"
EX_Port FID Neighbor Switch Info (WWN, enet IP, name)
-----
4 95 10:00:00:05:1e:37:00:45 10.32.156.31 "Brocade 5300"
5 95 10:00:00:05:1e:37:00:45 10.32.156.31 "Brocade 5300"
6 95 10:00:00:05:1e:37:00:45 10.32.156.31 "Brocade 5300"

```

## FC router port cost configuration

The FC router port cost is set automatically. This section provides information about the router port cost and describes how you can modify the cost for a port if you want to change the default value.

FC routers optimize the usage of the router port links by directing traffic to the link with the smallest router port cost. The FC router port cost is similar to the link cost setting available on E\_Ports, which allows you to customize traffic flow. The router port link cost values are either 1000 or 10,000. The router module chooses the router port path based on the lowest cost for each FID connection. If multiple paths exist where one path costs less than the others, then the lowest cost path is used. If exchange-based routing has not been disabled and multiple paths exist with the same lowest cost, there will be load sharing over these paths.

The FC router port cost feature optimizes the usage of the router port links by directing the traffic to a link with a smaller cost.



Every IFL has a default cost. The default router port cost values are:

- 1000 for a legacy (v5.1 or XPath FCR) IFL
- 1000 for an EX\_Port IFL
- 10,000 for a VEX\_Port IFL

The FC router port cost settings are 0, 1000, or 10,000. If the cost is set to 0, the default cost will be used for that IFL. The FC router port cost is persistent and is saved in the existing port configuration file.

FC router port cost is passed to other routers in the same backbone. Link costs from the front domain to the translate (xlate) domain remain at 10,000. You can use the **IsDbShow** command from the edge fabric to display these link costs.

## Port cost considerations

The router port cost has the following considerations:

- Router port sets are defined as follows:
  - 0–7 and FCIP Tunnel 16–23
  - 8–15 and FCIP Tunnel 24–31
- The router port cost does not help distinguish one IFL (or EX\_ and VEX\_Port link) from another, if all the IFLs are connected to the same port set. Therefore, if you connect IFL1 and IFL2 to the same edge fabric in port set 0–7 and then configure them to different router port costs, traffic is still balanced across all the IFLs in the same port set.
- Use proper SAN design guidelines to connect the IFLs to different port sets for effective router port cost use. For example, if both a low-speed IFL and a high-speed IFL are going to the same edge fabric, connect the lower router cost IFL to a separate port group (for example, ports 0–7) than the higher router cost IFL (for example, ports 8–15). For VEX\_Ports, you would use ports in the range of 16–23 or 24–31.

You can connect multiple EX\_Ports or VEX\_Ports to the same edge fabric. The EX\_Ports can all be on the same FC router, or they can be on multiple routers. Multiple EX\_Ports create multiple paths for frame routing. Multiple paths can be used in two different, but compatible, ways:

- Failing over from one path to another.
- Using multiple paths in parallel to increase effective data transmission rates.

EX\_Ports and VEX\_Ports, when connected, are assigned different router port costs and traffic will flow only through the EX\_Ports. Routing failover is automatic, but it can result in frames arriving out of order when frames take different routes. The FC router can force in-order delivery, although frame delivery is delayed immediately after the path failover.

Source EX\_Ports can balance loads across multiple destination EX\_Ports attached to the same edge fabric using exchange IDs from the routed frames as keys to distribute the traffic.

## Setting router port cost for an EX\_Port

The router port cost value for an EX\_Port is set automatically when the EX\_Port is created. However, you can modify the cost for that port. You can configure the EX\_Port or VEX\_Port with values of either 1000 or 10,000. If you want to differentiate between two EX\_Port links with different speeds, you can assign 1000 to one link and 10,000 to the other link.

For details about the use of any of the following commands, refer to the *Fabric OS Command Reference*.

1. Enter the **portDisable** command to disable any port on which you want to set the router port cost.

```
switch:admin> portdisable 7/10
```

2. Enable EX\_Port or VEX\_Port mode with the **portCfgEXPort** or **portCfgVEXPort** command.

```
switch:admin> portcfgexport 7/10 -a 1
```

3. Enter the **fcRouterPortCost** command to display the router port cost for each EX\_Port.

```
switch:admin> fcrouterportcost
Port                Cost
-----
7/3                 1000
7/4                 1000
7/9                 1000
7/10                1000
7/13                1000
10/0                1000
```

You can also use the **fcRouteShow** command to display the router port cost.

To display the router port cost for a single EX\_Port, enter the **fcRouterPortCost** command with a port and slot number.

```
switch:admin> fcrouterportcost 7/10
Port                Cost
-----
7/10                1000
```

4. Enter the appropriate form of the **fcRouterPortCost** command based on the task you want to perform:

- To set the router port cost for a single EX\_Port, enter the command with a port and slot number and a specific cost:

```
switch:admin> fcrouterportcost 7/10 10000
```

- To set the cost of the EX\_Port back to the default, enter a cost value of 0:

```
switch:admin> fcrouterportcost 7/10 0
```

5. Enter the **portEnable** command to enable the ports that you disabled in [step 1](#).

```
switch:admin> portenable 7/10
```

## EX\_Port frame trunking configuration

You can configure EX\_Ports to use frame-based trunking just as you do regular E\_Ports. EX\_Port frame trunking support is designed to provide the best utilization and balance of frames transmitted on each link between the FC router and the edge fabric. You should trunk all ports connected to the same edge fabrics.

The FC router front domain has a higher node WWN—derived from the FC router—than that of the edge fabric. Therefore, the FC router front domain initiates the trunking protocol on the EX\_Port.

After initiation, the first port from the trunk group that comes online is designated as the master port. The other ports that come online on the trunk group are considered the slave ports. Adding or removing a slave port does not cause frame drop; however, removing a slave port causes the loss of frames in transit.

The restrictions for EX\_Port frame trunking are the same as for E\_Ports—all the ports must be adjacent to each other using the clearly marked groups on the front of the product.

---

**ATTENTION**

This feature should be enabled only if the entire configuration is running Fabric OS v5.2.0 or later.

---

If router port cost is used with EX\_Port trunking, the master port and slave ports share the router port cost of the master port.

For information about setting up E\_Port trunking on an edge fabric, refer to [Chapter 22, “Managing Trunking Connections”](#).

## LSAN zone configuration

An LSAN consists of zones in two or more edge or backbone fabrics that contain the same devices. LSANs provide selective device connectivity between fabrics without forcing you to merge those fabrics. FC routers provide multiple mechanisms to manage inter-fabric device connectivity through extensions to existing switch management interfaces. You can define and manage LSANs using Brocade Advanced Zoning.

---

**NOTE**

For performance reasons, Brocade recommends that you do not configure LSANs for device sharing between Fabric OS fabrics until after you activate the Integrated Routing license.

---

### Use of Admin Domains with LSAN zones and FC-FC routing

You can create LSAN zones as a physical fabric administrator or as an individual Admin Domain (AD) administrator. The LSAN zone can be part of the root zone database or the AD zone database. FCR harvests the LSAN zones from all administrative domains. If both edge fabrics have the matching LSAN zones and both devices are online, FCR triggers a device import. To support legacy applications, WWNs are reported based on the Admin Domain context. As a result, you must not use the network address authority (NAA) field in the WWN to detect an FC router. LSAN zone enforcement in the local fabric occurs only if the Admin Domain member list contains both of the devices (local and imported device) specified in the LSAN zone.

For more information, refer to [Chapter 17, “Managing Administrative Domains”](#).

### Zone definition and naming

Zones are defined locally on a switch or Backbone. Names and memberships, with the exception of hosts and targets exported from one fabric to another, do not need to be coordinated with other fabrics. For example, in [Figure 74](#) on page 471, when the zones for Edge SAN 1 are defined, you do not need to consider the zones in Edge SAN 2, and vice versa.

Zones that contain hosts and targets that are shared between the two fabrics must be explicitly coordinated. To share devices between any two fabrics, you must create an LSAN zone in both fabrics containing the port WWNs of the devices to be shared. Although an LSAN is managed using the same tools as any other zone on the edge fabric, two behaviors distinguish an LSAN from a conventional zone:

- A required naming convention. The name of an LSAN begins with the prefix “LSAN\_”. The LSAN name is not case-sensitive; for example, *lsan\_* is equivalent to *LSAN\_*, *Lsan\_*, and so on.
- Members must be identified by their port WWN because port IDs are not necessarily unique across fabrics. The names of the zones need not be explicitly the same, and membership lists of the zones need not be in the same order.

---

#### NOTE

The “LSAN\_” prefix must appear at the beginning of the zone name. LSAN zones may not be combined with QoS zones. Refer to “[QoS zones](#)” on page 424 for more information about the naming convention for QoS zones.

---

To enable device sharing across multiple fabrics, you must create LSAN zones on the edge fabrics (and optionally on the backbone fabric as well), using normal zoning operations to create zones with names that begin with the special prefix “LSAN\_”, and adding host and target port WWNs from both local and remote fabrics to each local zone as desired. Zones on the backbone and on multiple edge fabrics that share a common set of devices will be recognized as constituting a single multi-fabric LSAN zone, and the devices that they have in common will be able to communicate with each other across fabric boundaries.

## LSAN zones and fabric-to-fabric communications

Zoning is enforced by all involved fabrics; any communication from one fabric to another must be allowed by the zoning setup on both fabrics. If the SANs are under separate administrative control, then separate administrators maintain access control.

## Controlling device communication with the LSAN

The following procedure illustrates how LSANs control which devices can communicate with each other. The procedure shows the creation of two LSANs (called *lsan\_zone\_fabric75* and *lsan\_zone\_fabric2*), which involve the following devices and connections:

- Switch1 and the host in fabric75.
- Switch2, Target A, and Target B in fabric2.
- Switch1 is connected to the FC router using an EX\_Port or VEX\_Port.
- Switch2 is connected to the FC router using another EX\_Port or VEX\_Port.
- Host has WWN 10:00:00:00:c9:2b:c9:0c (connected to switch1).
- Target A has WWN 50:05:07:61:00:5b:62:ed (connected to switch2).
- Target B has WWN 50:05:07:61:00:49:20:b4 (connected to switch2).

1. Log in as admin and connect to switch1.
2. Enter the **nsShow** command to list the WWN of the host (10:00:00:00:c9:2b:c9:0c).

---

#### NOTE

The **nsShow** output displays both the port WWN and node WWN; the port WWN must be used for LSANs.

---

```
switch:admin> nsshow
{
  Type Pid      COS      PortName      NodeName
  TTL(sec)
  N   060f00;  2,3;   10:00:00:00:c9:2b:c9:0c;  20:00:00:00:c9:2b:c9:0c; na
    FC4s: FCP
    NodeSymb: [35] "Emulex LP9002 FV3.91A3 DV5-5.20A6 "
    Fabric Port Name: 20:0f:00:05:1e:37:00:44
    Permanent Port Name: 10:00:00:00:c9:2b:c9:0c
  The Local Name Server has 1 entry }
```

3. Enter the **zoneCreate** command to create the LSAN *lsan\_zone\_fabric75*, which includes the host.

```
switch:admin> zonecreate "lsan_zone_fabric75", "10:00:00:00:c9:2b:c9:0c"
```

4. Enter the **zoneAdd** command to add Target A to the LSAN.

```
FID75Domain5:admin> zoneadd "lsan_zone_fabric75", "50:05:07:61:00:5b:62:ed"
```

5. Enter the **cfgAdd** or **cfgCreate** and **cfgEnable** commands to add and enable the LSAN configuration.

```
switch:admin> cfgadd "zone_cfg", "lsan_zone_fabric75"
switch:admin> cfgenable "zone_cfg"
You are about to enable a new zoning configuration.
This action will replace the old zoning configuration with the
current configuration selected.
Do you want to enable 'zone_cfg' configuration (yes, y, no, n): [no] y
zone config "zone_cfg" is in effect
Updating flash ...
```

6. Log in as admin to fabric2.
7. Enter the **nsShow** command to list Target A (50:05:07:61:00:5b:62:ed) and Target B (50:05:07:61:00:49:20:b4).

```
switch:admin> nsshow
{
  Type Pid      COS      PortName      NodeName      TTL(sec)
  NL   0508e8;  3;      50:05:07:61:00:5b:62:ed;  50:05:07:61:00:1b:62:ed; na
    FC4s: FCP [IBM      DNEF-309170      F90F]
    Fabric Port Name: 20:08:00:05:1e:34:11:e5
    Permanent Port Name: 50:05:07:61:00:5b:62:ed
  NL   0508ef;  3;      50:05:07:61:00:49:20:b4;  50:05:07:61:00:09:20:b4; na
    FC4s: FCP [IBM      DNEF-309170      F90F]
    Fabric Port Name: 20:08:00:05:1e:34:11:e5
    Permanent Port Name: 50:05:07:61:00:49:20:b4
  The Local Name Server has 2 entries }
```

8. Enter the **zoneCreate** command to create the LSAN *lsan\_zone\_fabric2*, which includes the host (10:00:00:00:c9:2b:6a:2c), Target A, and Target B.

```
switch:admin> zonecreate "lsan_zone_fabric2",
"10:00:00:00:c9:2b:c9:0c;50:05:07:61:00:5b:62:ed;50:05:07:61:00:49:20:b4"
```

9. Enter the **cfgShow** command to verify that the zones are correct.

```
switch:admin> cfgshow
Defined configuration:
```

```
zone: lsan_zone_fabric2
      10:00:00:00:c9:2b:c9:0c; 50:05:07:61:00:5b:62:ed;
      50:05:07:61:00:49:20:b4
```

```
Effective configuration:
no configuration in effect
```

- Enter the **cfgAdd** and **cfgEnable** commands to create and enable the LSAN configuration.

```
switch:admin> cfgadd "zone_cfg", "lsan_zone_fabric2"
switch:admin> cfgenable "zone_cfg"
You are about to enable a new zoning configuration.
This action will replace the old zoning configuration with the
current configuration selected.
Do you want to enable 'zone_cfg' configuration (yes, y, no, n): [no] y
zone config "zone_cfg" is in effect
Updating flash ...
```

- Log in as an admin and connect to the FC router.

- Enter the following commands to display information about the LSANs:

- lsanZoneShow -s** shows the LSAN.

```
switch:admin> lsanzoneshow -s
Fabric ID: 2 Zone Name: lsan_zone_fabric2
      10:00:00:00:c9:2b:c9:0c Imported
      50:05:07:61:00:5b:62:ed EXIST
      50:05:07:61:00:49:20:b4 EXIST
Fabric ID: 75 Zone Name: lsan_zone_fabric75
      10:00:00:00:c9:2b:c9:0c EXIST
      50:05:07:61:00:5b:62:ed Imported
```

- fcrPhyDevShow** shows the physical devices in the LSAN.

```
switch:admin> fcrphydevshow
      Device           WWN           Physical
      Exists
      in Fabric
-----
      75 10:00:00:00:c9:2b:c9:0c c70000
      2  50:05:07:61:00:49:20:b4 0100ef
      2  50:05:07:61:00:5b:62:ed 0100e8
Total devices displayed: 3
```

- fcrProxyDevShow** shows the proxy devices in the LSAN.

```
switch:admin> fcrproxydevshow
      Proxy           WWN           Proxy           Device           Physical           State
      Created
      in Fabric
-----
      75  50:05:07:61:00:5b:62:ed 01f001           2           0100e8           Imported
      2  10:00:00:00:c9:2b:c9:0c 02f000           75           c70000           Imported
Total devices displayed: 2
```

On the FC router, the host and Target A are imported, because both are defined by *lsan\_zone\_fabric2* and *lsan\_zone\_fabric75*. However, Target B is defined by *lsan\_zone\_fabric2* and is not imported because *lsan\_zone\_fabric75* does not allow it.

When a PLOGI, PDISC, or ADISC arrives at the FC router, the SID and DID of the frame are checked. If they are LSAN-zoned at both SID and DID edge fabrics, the frame is forwarded to the DID. If they are not zoned, only the PLOGI is dropped; for the remaining frames zoning enforcement takes place in the edge fabrics.

## Configuring backbone fabrics for interconnectivity

If you want devices in backbone fabrics to communicate with devices in edge fabrics, set up the LSANs as described in the section [“Controlling device communication with the LSAN”](#) on page 486. However, instead of configuring the LSAN in the second edge fabric, configure the LSAN in the backbone fabric.

## Setting the maximum LSAN count

You can set the maximum number of LSAN zones, or LSAN count, that can be configured on the edge fabrics. By default, the maximum LSAN count is set to 3000. You can increase the maximum LSAN count to 5000 without disabling the switch.

The maximum number of LSAN devices supported is 10,000 (this includes both physical and proxy devices). If you have 3000 LSAN zones but have not exceeded the 10,000 device limit, you can increase the LSAN count to 5000.

All FC routers in the same backbone fabric should have the same maximum LSAN count defined, to prevent the FC routers from running into indefinite state. Asymmetric LSAN configurations due to different maximum LSAN counts could lead to different devices being imported on different FC routers.

1. Enter the **fcrlsancount** command with no parameters to display the current LSAN limit.

```
switch:admin> fcrlsancount
LSAN Zone Limit 3000
```

2. Enter the **fcrlsancount** command and specify the new LSAN zone limit.

```
switch:admin> fcrlsancount 5000
LSAN Zone Limit 5000
```

For information on how to display the maximum allowed and currently used LSAN zones and devices, refer to [“Resource monitoring”](#) on page 500.

---

### NOTE

Because the maximum number of LSANs is configured for each switch, if there is a different maximum LSAN count on the switches throughout the metaSAN, then the device import/export will not be identical on the FC routers. You should enter the same maximum LSAN count for all the FC routers in the same backbone that support this feature. Verify the configured maximum limit against the LSANs configured using the **fcrResourceShow** command.

---

## HA and downgrade considerations for LSAN zones

Be aware of how LSAN zones impact high availability and firmware downgrades:

- The LSAN zone matrix is synchronized to the standby CP.
- On a dual CP switch, both CPs must have Fabric OS v5.3.0 or later to enable the feature.
- If the feature is enabled on the active CP, introducing a CP with an earlier version of Fabric OS as a standby will cause HA synchronization to fail.
- If the feature is enabled, before downgrading to an earlier Fabric OS version, you will be asked to go back to the default mode.
- This feature does not have any impact on current HA functionality. LSANs will be synchronized as usual after the limit is increased and new LSANs are created.

## LSAN zone policies using LSAN tagging

You can create tags for LSAN zones to give them a special meaning.

LSAN zones are zones with names that start with the “lsan\_” prefix. You can specify a tag to append to this prefix that causes the LSAN zone to be treated differently.

You can specify two types of tags:

- Enforce tag – Specifies which LSANs are to be enforced in an FC router.
- Speed tag – Specifies which LSANs are to be imported or exported faster than other LSANs.

The LSAN tags are persistently saved and support **configupload** and **configdownload**.

### *Enforce tag*

The Enforce tag reduces the resources used in an FC router by limiting the number of LSAN zones that will be enforced in that FC router.

Use the Enforce tag to achieve better scalability in the FC router. This is useful when multiple FC routers are connected to the same edge fabric. Without the Enforce tag, all FC routers import all LSAN zones, even those that are not needed.

Normally, the FC router automatically accepts all zones with names that start with “lsan\_”. You can specify an Enforce tag to indicate that a particular FC router should only accept zones that start with the prefix “lsan\_tag”. For example, if you specify an Enforce tag of “abc”, the FC router accepts only those LSAN zones that start with “lsan\_abc” and does not import or export any other LSAN zones.

The Enforce tag can be up to eight characters long and can contain only letters and numbers. The Enforce tag is not case-sensitive; for example, the tag “abc” is equivalent to “ABC” and “Abc”.

If you specify “abc”, “xyz”, and “fab1” as Enforce tags, then the FC router accepts only those LSAN zones with names that start with any of the following:

```
lsan_abc
lsan_xyz
lsan_fab1
```

In this example, the following LSAN zones would all be accepted:

```
lsan_abc
lsan_xyz123456
LSAN_FAB1_abc
```

You can specify up to eight Enforce tags on an FC router.

### *Speed tag*

During target discovery, the FC router process of presenting proxy devices and setting up paths to the proxy devices may cause some sensitive hosts to time out or fail. The Speed tag allows you to speed up the discovery process by importing the devices into the remote edge fabrics when the devices come online, regardless of the state of the host. This helps sensitive hosts to quickly discover the devices without timing out.

You set the Speed tag on the FC router, and then configure the LSANs in the target edge fabrics with the tag.



For example, in [Figure 78](#) on page 491, assume that the host, H1, needs fast access to target devices D1 and D2. You could set up the Speed tag as follows:

1. In FC router 1 and FC router 2, configure the Speed tag as “super”.

2. In Edge fabric 2, configure two LSANs:

```
lsan_f2_f1 (H1, D1)
```

```
lsan_f2_f3 (H1, D2)
```

The LSAN in the host fabric does not need the tag.

3. In Edge fabric 1, configure the following LSAN:

```
lsan_super_f1_f2 (H1, D1)
```

4. In Edge fabric 3, configure the following LSAN:

```
lsan_super_f3_f2 (H1, D2)
```

5. Toggle either the host or target to trigger the fast import process.

The “super” tag is needed only in the LSANs of the target fabrics.

The target proxies D1 and D2 are always present in the host fabric (Edge fabric 2), even if the host is brought down. A target proxy is removed from the host fabric when the target device is offline.

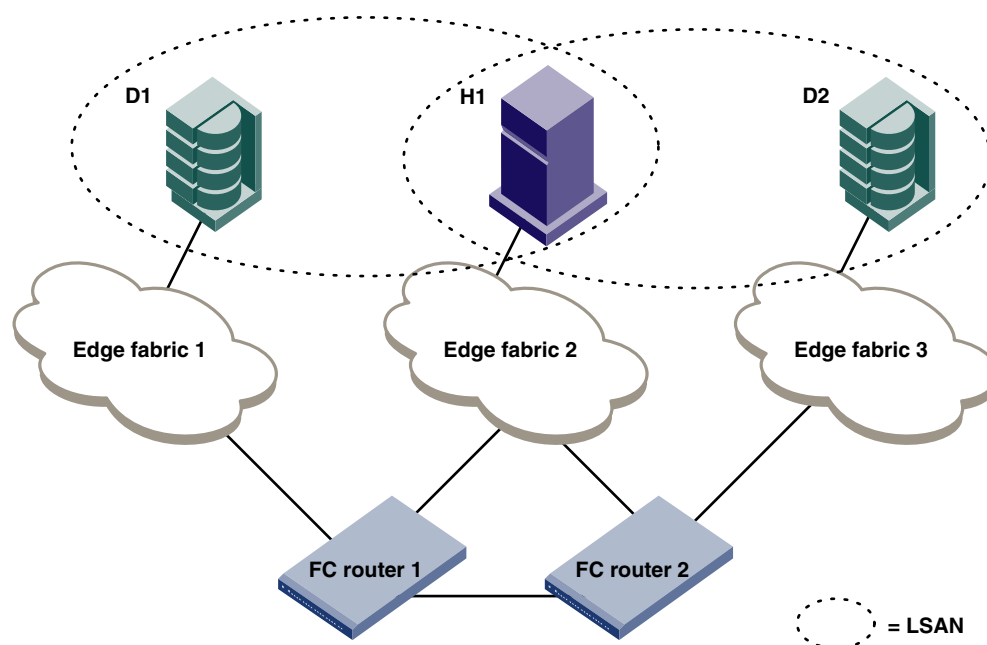

FIGURE 78 Example of setting up Speed LSAN tag

### *Rules for LSAN tagging*

Note the following rules for configuring LSAN tags:

- You configure the tags on the FC router, and not on the edge switches. If Virtual Fabrics is enabled, you configure the tags on the base switch on which the EX\_Ports and VEX\_Ports are located. You then must ensure that the LSAN zones in the edge fabrics incorporate the tags correctly.

- The LSAN tags are configured per FC router, not per fabric. If the backbone fabric has multiple FC routers, it is recommended that you configure the LSAN tags on all of the FC routers.
- The FC router must be disabled before you configure the Enforce tag. Configuring the Speed tag does not require that the FC router be disabled; however, after configuring the Speed tag, you must toggle the host or target port to trigger the fast import process.
- The tag is from 1 through 8 alphanumeric characters.
- You can configure only one Speed tag on an FC router, and up to eight Enforce tags on an FC router. The maximum number of tags (Enforce and Speed) on an FC router is eight.
- Up to 500 Speed LSAN tags are supported.

### *Configuring an Enforce LSAN tag*

1. Log in to the FC router as admin.
2. Enter the following command to disable the FC router:

```
switchdisable
```

3. Enter the following command to create an Enforce LSAN tag:

```
fcrlsan --add -enforce tagname
```

The *tagname* variable is the name of the LSAN tag you want to create.

4. Enter the following command to enable the FC router:

```
switchenable
```

5. Change the names of the LSAN zones in the edge fabrics to incorporate the tag in the names.

#### **Example**

```
sw0:admin> switchdisable
sw0:admin> fcrlsan --add -enforce enftag1
LSAN tag set successfully
sw0:admin> switchenable
```

### *Configuring a Speed LSAN tag*

1. Log in to the FC router as admin.
2. Enter the following command to create a Speed LSAN tag:

```
fcrlsan --add -speed tagname
```

The *tagname* variable is the name of the LSAN tag you want to create.

3. Change the names of the LSAN zones in the edge fabrics to incorporate the tag in the names.
4. Toggle the host or target port to trigger the fast import process.

#### **Example**

```
sw0:admin> fcrlsan --add -speed fasttag2
LSAN tag set successfully
```

## *Removing an LSAN tag*

Use the following procedure to remove an LSAN tag. This procedure does not remove the LSAN zone; it deactivates the tag so that LSAN zones with this tag in the name now behave as regular LSAN zones.

You must disable the switch before removing an Enforce LSAN tag. You do not need to disable the switch to remove a Speed LSAN tag.

1. Log in to the FC router as admin.
2. Enter the **fcrlsan --remove** command to remove an existing LSAN tag.

If you remove an Enforce LSAN tag, you must disable the switch first.

### **Example of removing an Enforce LSAN tag**

```
sw0:admin> switchdisable
sw0:admin> fcrlsan --remove -enforce enftag1
LSAN tag removed successfully
sw0:admin> switchenable
```

### **Example of removing a Speed LSAN tag**

```
sw0:admin> fcrlsan --remove -speed fasttag2
LSAN tag removed successfully
```

## *Displaying the LSAN tag configuration*

1. Log in to the FC router as admin.
2. Enter the **fcrlsan --show** command.

### **Example**

```
sw0:admin> fcrlsan --show -enforce

Total LSAN tags : 1
  ENFORCE : enftag1
sw0:admin> fcrlsan --show -speed

Total SPEED tags : 1
  SPEED : fasttag2
sw0:admin> fcrlsan --show -all

Total LSAN tags : 2
  ENFORCE : enftag1
  SPEED   : fasttag2
```

## **LSAN zone binding**

LSAN zone binding is an optional, advanced feature that increases the scalability envelope for very large metaSANs.

---

### **NOTE**

LSAN zone binding is supported only on FC routers with Fabric OS v5.3.0 and later. The FC router matrix feature is supported only on FC routers with Fabric OS v6.1.0 and later.

---

Without LSAN zone binding, every FC router in the backbone fabric maintains the entire LSAN zone and device state database. The size of this database limits the number of FC routers and devices you can have.

With LSAN zone binding, each FC router in the backbone fabric stores only the LSAN zone entries of the remote edge fabrics that can access its local edge fabrics. The LSAN zone limit supported in the backbone fabric is not limited by the capability of one FC router. In addition, due to the lower LSAN count, the CPU consumption by the FC router is lower. If you configure the metaSAN such that the backbone fabric has two groups of FC routers and there is no LSAN zone sharing and device access between the two groups, the number of FC routers and devices supported in the backbone fabric can be higher.

Figure 79 on page 494 shows a sample metaSAN with four FC routers in the backbone fabric. Without LSAN zone binding, each FC router in the backbone fabric would store information about LSAN zones 1, 2, 3, and 4.

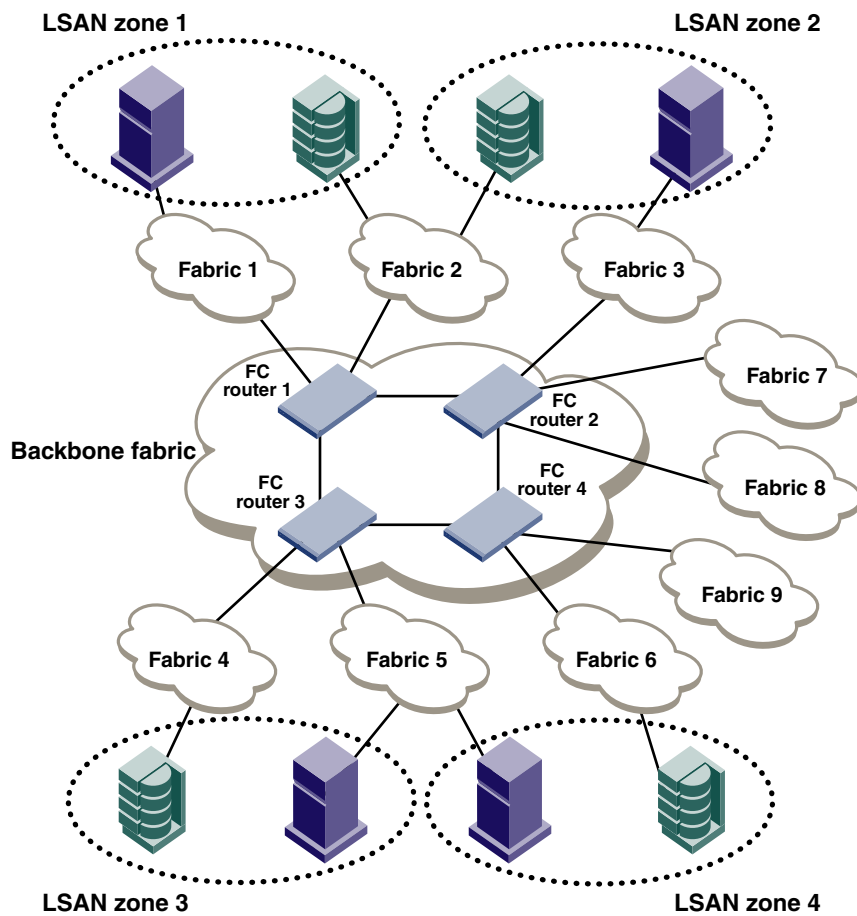

FIGURE 79 LSAN zone binding

After you set up LSAN zone binding, each FC router stores information about only those LSAN zones that access its local edge fabrics. Table 81 shows what LSAN information is stored in each FC router before and after LSAN zone binding is in effect.

**TABLE 81** LSAN information stored in FC routers, with and without LSAN zone binding

Without LSAN zone binding				With LSAN zone binding			
FC router 1	FC router 2	FC router 3	FC router 4	FC router 1	FC router 2	FC router 3	FC router 4
LSAN 1	LSAN 1	LSAN 1	LSAN 1	LSAN 1	LSAN 2	LSAN 3	LSAN 4
LSAN 2	LSAN 2	LSAN 2	LSAN 2	LSAN 2		LSAN 4	
LSAN 3	LSAN 3	LSAN 3	LSAN 3				
LSAN 4	LSAN 4	LSAN 4	LSAN 4				

### *LSAN zone binding considerations*

- Without LSAN zone binding, the maximum number of LSAN devices is 10,000.
- With LSAN zone binding, the metaSAN can import more than 10,000 devices and the backbone fabric can support more FC routers.
- With LSAN zone binding, CPU consumption by an FC router is lower.

### *How LSAN zone binding works*

LSAN zone binding uses an *FC router matrix*, which specifies pairs of FC routers in the backbone fabric that can access each other, and an *LSAN fabric matrix*, which specifies pairs of edge fabrics that can access each other.

You set up LSAN zone binding using the `fcrLsanMatrix` command. This command has two options: `-fcr` and `-lsan`. The `-fcr` option is for creating and updating the FC router matrix, and the `-lsan` option is used for creating and updating the LSAN fabric matrix.

#### **NOTE**

**Best practice:** Use this feature in a backbone fabric in which all FC routers are running Fabric OS v6.1.0 or later.

When you set up LSAN zone binding on the local FC router (running Fabric OS v6.1.0 or later), the resultant matrix database is automatically distributed to all of the Fabric OS v6.1.0 or later FC routers in the backbone fabric. You do not need to set up LSAN zone binding on the other FC routers unless those FC routers are running Fabric OS versions earlier than v6.1.0.

If a new FC router joins the backbone fabric, the matrix database is automatically distributed to that FC router unless it has a different LSAN fabric matrix or FC router matrix or both defined already.

Note the following for FC routers running a Fabric OS version earlier than 6.1.0:

- The matrix database is not automatically distributed from this FC router to other FC routers.
- You must manually configure the LSAN fabric matrix on these FC routers to match the other FC routers in the backbone fabric.

If you have a dual backbone configuration, where two backbone fabrics share edge fabrics, the LSAN fabric matrix and FC router matrix settings for the shared edge fabrics must be the same on both backbone fabrics. The matrix databases are *not* automatically propagated from one backbone fabric to another, so you must ensure that both backbone fabrics have the same matrix settings.

#### **NOTE**

You can use LSAN zone binding along with LSAN tagging to achieve better scalability and performance. Refer to [“LSAN zone policies using LSAN tagging”](#) on page 490 for information about using the Enforce LSAN tag.

### *FC router matrix definition*

Depending on the structure of the backbone fabric, you can specify pairs of FC routers that can access each other. For the metaSAN shown in [Figure 79](#), the following FC routers can access each other:

- FC router 1 and FC router 2
- FC router 3 and FC router 4

Because there is no device sharing between the two groups of FC routers, you can use the **fcrLsanMatrix** command with the **-fcr** option to create the corresponding FC router matrix:

```
fcrLsanMatrix --add -fcr wwn1 wwn2
fcrLsanMatrix --add -fcr wwn3 wwn4
```

The variables *wwn1*, *wwn2*, *wwn3*, and *wwn4* are the WWNs of the four FC routers.

Now edge fabrics 1, 2, 3, 7, and 8 can access each other, and edge fabrics 4, 5, 6, and 9 can access each other; however, edge fabrics in one group cannot access edge fabrics in the other group. The edge fabrics can still communicate with the backbone fabric.

### *LSAN fabric matrix definition*

With LSAN zone binding, you can specify pairs of fabrics that can access each other. Using the metaSAN shown in [Figure 79](#) as an example, the following edge fabrics can access each other:

- Fabric 1 and Fabric 2
- Fabric 2 and Fabric 3
- Fabric 4 and Fabric 5
- Fabric 5 and Fabric 6

You can use the **fcrLsanMatrix** command with the **-lsan** option to create the corresponding LSAN fabric matrix:

```
fcrLsanMatrix --add -lsan 1 2
fcrLsanMatrix --add -lsan 2 3
fcrLsanMatrix --add -lsan 4 5
fcrLsanMatrix --add -lsan 5 6
```

Fabrics that are not specified are part of the default binding and can access other edge fabrics that are not specified. Thus, fabrics 7, 8, and 9 can access each other, but cannot access fabrics 1 through 6.

---

**ATTENTION**

The **fcrLsanMatrix --add -lsan 0 0** command will erase the entire LSAN fabric matrix settings in the cache.

---

The FC router matrix and the LSAN fabric matrix are used together to determine which fabrics can access each other, with the LSAN fabric matrix providing more specific binding.

### *Setting up LSAN zone binding*

1. Log in to the FC router as admin.
2. Enter the following command to add a pair of FC routers that can access each other:

```
FCR:Admin> fcrlsanmatrix --add -fcr wwn1 wwn2
```

The variables *wwn1* and *wwn2* are the WWNs of the FC routers.

3. Enter the following command to add a pair of edge fabrics that can access each other:

```
FCR:Admin> fcrlsanmatrix --add -lsan fid1 fid2
```

The variables *fid1* and *fid2* are the fabric IDs of the edge fabrics.

4. Enter the following command to apply the changes persistently:

```
FCR:Admin> fcrlsanmatrix --apply -all
```

#### **Example**

```
FCR:Admin> fcrlsanmatrix --add -fcr 10:00:00:60:69:c3:12:b2
10:00:00:60:69:c3:12:b3
FCR:Admin> fcrlsanmatrix --add -lsan 4 5
FCR:Admin> fcrlsanmatrix --add -lsan 4 7
FCR:Admin> fcrlsanmatrix --add -lsan 10 19
FCR:Admin> fcrlsanmatrix --apply -all
```

### *Viewing the LSAN zone binding matrixes*

1. Log in to the FC router as admin.
2. Enter the following command to view the FC router matrix:

```
fcrlsanmatrix --fabricview -fcr
```

3. Enter the following command to view the LSAN fabric matrix:

```
fcrlsanmatrix --fabricview -lsan
```

#### **Example**

```
FCR:Admin> fcrlsanmatrix --fabricview -fcr

SAVED FCR PAIRS
=====
FCR                                FCR
-----
10:00:00:60:69:c3:12:b2 (2)      10:00:00:60:69:c3:12:b3 (unknown)

FCR:Admin> fcrlsanmatrix --fabricview -lsan
LSAN MATRIX is activated

Fabric ID      Fabric ID
-----
4              5
4              7
10            19
```

## Proxy PID configuration

When an FC router is first configured, the PIDs for the proxy devices are automatically assigned. Proxy PIDs (as well as phantom domain IDs) persist across reboots.

The most common situation in which you would set a proxy PID is when you replace a switch. If you replace the switch and want to continue using the old PID assignments, you can configure it to do so; this value remains in the system even if the blade is replaced. To minimize disruption to the edge fabrics, set the proxy PIDs to the same values used with the old hardware.

The **fcProxyConfig** command displays or sets the persistent configuration of proxy devices. Used with the **-s slot** option, it can also influence the assignment of the xlate domain port number (which is used to determine the Area\_ID field of the PID) and the Port\_ID field. Like the PIDs in a fabric, a proxy PID must be unique. If the *slot* argument results in a duplicate PID, it will be ignored. Proxy PIDs are automatically assigned to devices imported into a fabric, starting at f001. For Proxy IDs projected to an M-EOS edge fabric in McDATA fabric mode, use valid ALPAs (lower 8 bits).

Use the **fcXlateConfig** command to display or assign a preferred domain ID to a translate domain.

## Fabric parameter considerations

By default, EX\_Ports and VEX\_Ports detect, autonegotiate, and configure the fabric parameters without user intervention.

You can optionally configure these parameters manually.

- To change the fabric parameters on a switch in the edge fabric, use the **configure** command.  
Note that to access all of the fabric parameters controlled by this command, you must disable the switch using the **switchDisable** command. If executed on an enabled switch, only a subset of attributes is configurable.
- To change the fabric parameters of an EX\_Port on the FC router, use the **portCfgEXPort** command.
- To change the fabric parameters of a VEX\_Port, use the **portCfgVEXPort** command.

The backbone fabric PID mode and the edge fabric PID mode do not need to match, but the PID mode for the EX\_Port or VEX\_Port and the edge fabric to which it is attached must match. You can statically set the PID mode for the fabric by using the **-p** option with the **portCfgEXPort** command. Use the **-t** option to disable the negotiate fabric parameter feature; otherwise, the PID mode is autonegotiated. The various edge fabrics may have different PID modes.

Fabric parameter settings, namely, E\_D\_TOV (error-detect timeout value), R\_A\_TOV (resource-allocation timeout value), and PID format, must be the same on EX\_Ports or VEX\_Ports and on the fabrics to which they are connected. You can set the PID format on an EX\_Port when you configure an inter-fabric link.

The default values for E\_D\_TOV and R\_A\_TOV for an EX\_Port or VEX\_Port must match those values on other Fabric OS switches. You do not need to adjust these parameters for an EX\_Port or VEX\_Port unless you have adjusted them for the edge fabric.

The default values for R\_A\_TOV and E\_D\_TOV are the recommended values for all but very large fabrics (ones requiring four or more hops) or high-latency fabrics (such as ones using long-distance FCIP links).



## Inter-fabric broadcast frames

The FC router can receive and forward broadcast frames between edge fabrics and between the backbone fabric and edge fabrics. Many target devices and HBAs cannot handle broadcast frames. In this case, you can set up broadcast zones to control which devices receive broadcast frames. (Refer to “[Broadcast zones](#)” on page 244 for information about setting up broadcast zones.)

By default, broadcast frames are *not* forwarded from the FC router to the edge fabrics.

---

### NOTE

Broadcast frame forwarding is not supported in an FCR fabric with a Brocade 8000. By default, broadcast frame forwarding is disabled on an FC router. If your edge fabric includes a Brocade 8000, do not enable broadcast frame forwarding on the FC router, because this can degrade FCR performance when there is excessive broadcast traffic.

---

## Displaying the current broadcast configuration

1. Log in to the FC router as admin.
2. Enter the following command:

```
fcr:admin> fcrbcastconfig --show
```

This command displays only the FIDs that have the broadcast frame option enabled. The FIDs that are not listed have the broadcast frame option disabled.

## Enabling broadcast frame forwarding

1. Log in to the FC router as admin.
2. Enter the following command:

```
fcr:admin> fcrbcastconfig --enable -f fabricID
```

The *fabricID* variable is the FID of the edge or backbone fabric on which you want to enable broadcast frame forwarding. Broadcast frame forwarding is enabled by default.

## Disabling broadcast frame forwarding

1. Log in to the FC router as admin.
2. Enter the following command:

```
fcr:admin> fcrbcastconfig --disable -f fabricID
```

The *fabricID* variable is the FID of the edge or backbone fabric on which you want to disable broadcast frame forwarding.

## Resource monitoring

It is possible to exhaust resources, such as proxy PIDs. Whenever a resource is exhausted, Fabric OS generates an error message. The messages are described in the *Fabric OS Message Reference*.

You can monitor FC router resources using the **fcrResourceShow** command. The **fcrResourceShow** command shows FCR resource limits and usage and includes the following:

- **LSAN zones and LSAN devices** — The information shows the maximum versus the currently used zones and device database entries. Each proxy or physical device constitutes an entry. If LSAN zones are defined in two edge fabrics, they are counted as two and not one. One device imported into multiple edge fabrics counts multiple times.

The default maximum number of LSAN zones is 3000. Refer to [“Setting the maximum LSAN count”](#) on page 489 for information on changing this limit.

- **Proxy Device Slots** — The physical and proxy devices use the 10,000 device slots.

The information shows the maximum pool size for translate phantom node and port WWNs and shows the number of translate node and port WWNs from this pool.

- Phantom Node WWNs
- Phantom Port WWNs
- Max proxy devices
- Max NR\_Ports

The following example shows the use of the **fcrResourceShow** command to display physical port (EX\_Port) resources.

```
switch:admin> fcrresourceshow
Daemon Limits:

```

	Max Allowed	Currently Used
LSAN Zones:	3000	28
LSAN Devices:	10000	51
Proxy Device Slots:	10000	20

	WWN Pool Size	Allocated
Phantom Node WWN:	8192	5413
Phantom Port WWN:	32768	16121

```
Port Limits:
Max proxy devices: 2000
Max NR_Ports: 1000

Currently Used(column 1: proxy, column 2: NR_Ports):
0 | 0 34
1 | 3 34
4 | 0 0
5 | 0 0
6 | 0 0
7 | 0 0
8 | 6 34
9 | 6 34
10 | 6 34
11 | 6 34
```

12	6	34
13	6	34
14	6	34
15	6	34
16	8	34
17	8	34
18	8	34
19	8	34
20	8	34
21	8	34
22	8	34
23	8	34

## FC-FC routing and Virtual Fabrics

If Virtual Fabrics is not enabled, FC-FC routing behavior is unchanged. If Virtual Fabrics is enabled, then in the FC-FC routing context, a base switch is like a backbone switch and a base fabric is like a backbone fabric.

If Virtual Fabrics is enabled, the following rules apply:

- EX\_Ports and VEX\_Ports can be configured only on the base switch.

When you enable Virtual Fabrics, the chassis is automatically rebooted. When the switch comes up, only one default logical switch is present, with the default fabric ID (FID) of 128. All previously configured EX\_Ports and VEX\_Ports are persistently disabled with the reason “ExPort in non base switch”. You must explicitly create a base switch, move the EX\_Ports and VEX\_Ports to the base switch, and then enable the ports.

If you move existing EX\_Ports or VEX\_Ports to any logical switch other than the base switch, these ports are automatically disabled.

If you want to change an EX\_Port or VEX\_Port on the logical switch to be a non-EX\_Port or VEX\_Port, you must use the **portCfgDefault** command. You cannot use the **portCfgExPort** command because that command is allowed only on the base switch.

- EX\_Ports can connect to a logical switch that is in the same chassis or a different chassis. However, the FID of the EX\_Port must be set to a different value than the FID of the logical switch to which it connects.
- EX\_Ports and VEX\_Ports – those in FC routers and those in a base switch – cannot connect to any edge fabric with logical switches configured to use XISLs.

If you connect an EX\_Port or VEX\_Port to an edge fabric, you must ensure that there are no logical switches with XISL use enabled in that edge fabric. If any logical switch in the edge fabric allows XISL use, then the EX\_Port or VEX\_Port is disabled. Refer to [“Configuring a logical switch to use XISLs”](#) on page 234 for instructions on disallowing XISL use.

Because XISL use is disallowed, dedicated links must be configured to route traffic across switches in the same logical fabric, as shown in [Figure 23](#) on page 217.

---

### ATTENTION

If you connect an EX\_Port or VEX\_Port from an FC router running Fabric OS v6.1.x or earlier to a logical switch that allows XISL use, the EX\_Port or VEX\_Port is *not* disabled; however, this configuration is not supported.

---

- Backbone-to-edge routing is not supported in the base switch. Refer to “[Backbone-to-edge routing with Virtual Fabrics](#)” on page 503 for information about how to configure legacy FC routers to allow backbone-to-edge routing with Virtual Fabrics.
- All FCR commands can be executed only in the base switch context.
- The **fcrConfigure** command is not allowed when Virtual Fabrics is enabled. Instead, use the **lsCfg** command to configure the FID.
- Although the Brocade 6510 supports up to four logical switches, if you are using FC-FC routing, the Brocade 6510 can have a maximum of only three logical switches.

## Logical switch configuration for FC routing

Figure 80 shows an example of two chassis partitioned into logical switches. This configuration allows the device in Fabric 128 to communicate with the device in Fabric 15 without merging the fabrics. Note the following:

- The base switch in Physical chassis 1 serves as an FC router and contains EX\_Ports that connect to logical switches in the two edge fabrics, Fabric 128 and Fabric 15.
- The other logical switches in Fabric 128 and Fabric 15 must be connected with physical ISLs, and do not use the XISL connection in the base fabric.
- The logical switches in Fabric 1 are configured to allow XISL use. You cannot connect an EX\_Port to these logical switches, so the device in Fabric 1 cannot communicate with the other two devices.

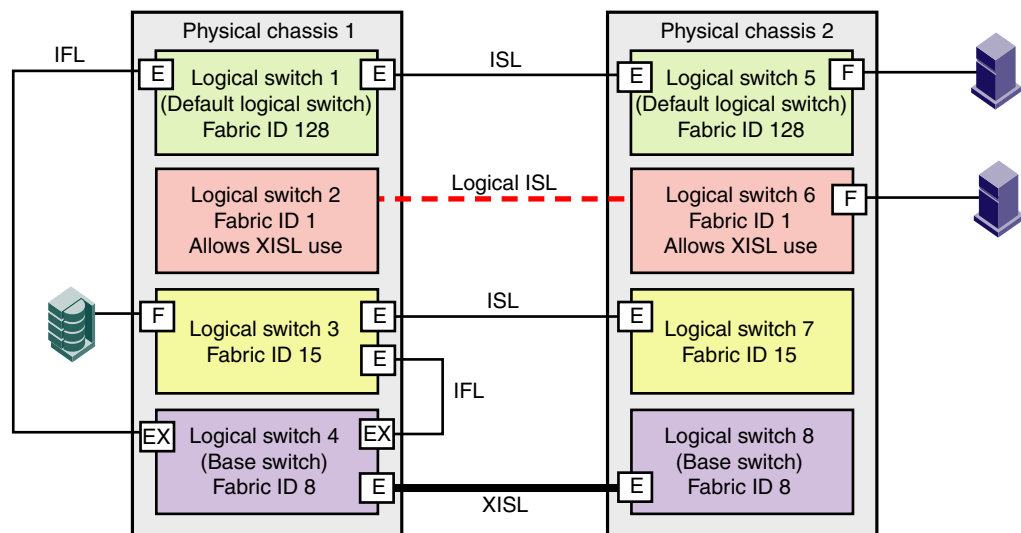

FIGURE 80 EX\_Ports in a base switch

Figure 81 shows a logical representation of the physical chassis and devices in Figure 80. As shown in Figure 81, Fabric 128 and Fabric 15 are edge fabrics connected to a backbone fabric. Fabric 1 is not connected to the backbone, so the device in Fabric 1 cannot communicate with any of the devices in the other fabrics.

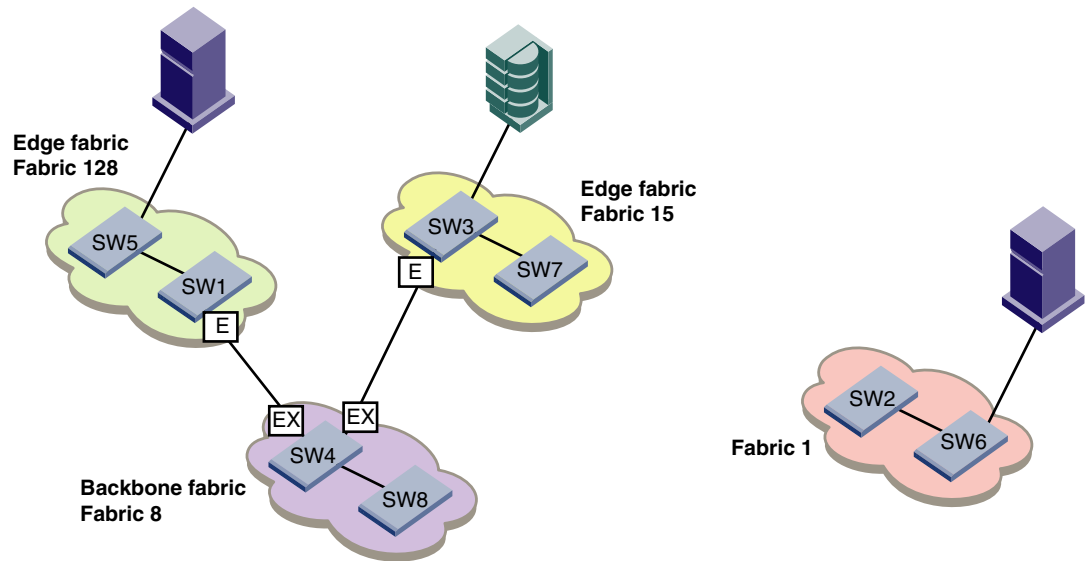

FIGURE 81 Logical representation of EX\_Ports in a base switch

## Backbone-to-edge routing with Virtual Fabrics

Backbone-to-edge routing is not supported in the base switch, unless you use a legacy FC router. A *legacy FC router* is an FC router configured on a Brocade 7500 switch or an FR4-18i blade.

Base switches can participate in a backbone fabric with legacy FC routers. You cannot connect devices to the base switch because the base switch does not allow F\_Ports. You can, however, connect devices to the legacy FC router, thus enabling backbone-to-edge routing.

If you connect a legacy FC router to a base switch, you must set the backbone FID of the FC router to be the same as that of the base switch.

In [Figure 80](#), no devices can be connected to the backbone fabric (Fabric 8) because base switches cannot have F\_Ports. [Figure 82](#) shows an FC router in legacy mode connected to a base switch. This FC router *can* have devices connected to it, and so you can have backbone-to-edge routing through this FC router. In this figure, Host A in the backbone fabric can communicate with device B in the edge fabric with FID 20; Host A cannot communicate with device C, however, because the base switches do not support backbone-to-edge routing.

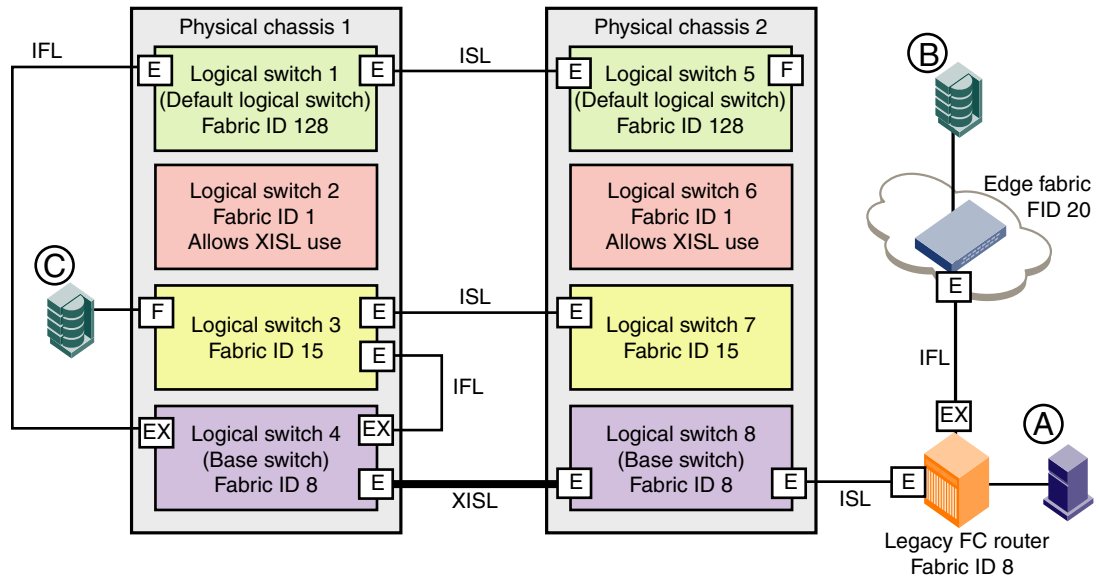

FIGURE 82 Backbone-to-edge routing across base switch using FC router in legacy mode

# Upgrade and downgrade considerations for FC-FC routing

When you upgrade to Fabric OS v7.0.0 or later, EX\_Ports remain functional and you can continue to perform all FC router operations on the switch.

**NOTE**  
 If EX\_Ports are present on the FR4-18i blade, upgrade to Fabric OS v7.0.0 or later is prevented. EX\_Ports are not supported on the FR4-18i blade in Fabric OS v7.0.0 or later. VEX\_Ports continue to be supported on this blade, however.

Brocade recommends that you save your FC-FC routing configuration (using the `configUpload` command) before performing any downgrades.

For further instructions on downgrading, refer to [Chapter 9, "Installing and Maintaining Firmware"](#).

## How replacing port blades affects EX\_Port configuration

If you replace an FR4-18i blade with an 8-Gbps port blade or FX8-24 blade, the EX\_Port configuration remains the same for the first 16 ports on the 8-Gbps port blade (and for the first 12 FC ports on the FX8-24 blade). For all other ports on the blade, the EX\_Port configuration is cleared. No ports are persistently disabled.

If you replace an 8-Gbps port blade or FX8-24 blade with an FR4-18i blade, the EX\_Port configuration remains the same for all ports on the FR4-18i blade. All ports are persistently disabled.

If you replace an 8-Gbps port blade with an FX8-24 blade, the EX\_Port configuration remains the same for the first 12 FC ports on the FX8-24 blade.

If you replace an 8-Gbps port blade or FX8-24 blade with another 8-Gbps port blade, the EX\_Port configuration remains the same.

## Displaying the range of output ports connected to xlate domains

The edge fabric detects only one front domain from an FC router connected through multiple output ports. The output port of the front domain is not fixed to 0; the values can be in a range from 129 through 255. The range of the output ports connected to the xlate domain is from 1 through 128. This range enables the front domain to connect to 127 remote xlate domains.

1. Log in to a switch in the edge fabric.
2. Enter the **lsDbShow** command on the edge fabric.

In the **lsDbShow** output, ports in the range from 129 through 255 are the output ports on the front domain.

The following example shows the range of output ports.

```
linkCnt = 2,    flags = 0x0
LinkId = 53, out port = 1, rem port = 35, cost = 500, costCnt = 0, type = 1
LinkId = 57, out port = 129, rem port = 18, cost = 500, costCnt = 0, type = 1
```

The following example also shows the use of the **lsDbShow** display on the edge fabric. The front domain, domain 3, has two links representing two EX\_Port connections with output ports 129 and 132.

```
Domain = 3, Link State Database Entry pointer = 0x100bbcc0
.....
linkCnt = 4,    flags = 0x0
LinkId = 199, out port = 129, rem port = 2, cost = 10000, costCnt = 0, type = 1
LinkId = 199, out port = 132, rem port = 3, cost = 10000, costCnt = 0, type = 1
LinkId = 2, out port = 1, rem port = 2, cost = 10000, costCnt = 0, type = 1
LinkId = 1, out port = 32, rem port = 2, cost = 10000, costCnt = 0, type = 1
```

## 24 Displaying the range of output ports connected to xlate domains



# Interoperation of Fabric OS and M-EOS Fabrics Using FC Router

---

## In this appendix

- [Interoperability overview](#) . . . . . 507
- [Establishing interoperability](#) . . . . . 509
- [Fabric configurations for interconnectivity](#). . . . . 510

## Interoperability overview

This appendix explains how to set up your Fabric OS SAN and M-EOS SAN to route traffic through FC router. Unlike with earlier releases of Fabric OS, you cannot mix Fabric OS v7.0.0 and later switches with M-EOS switches in the same L2 fabric. In Fabric OS v7.0.0 and later releases, the only way you can interoperate between Fabric OS and M-EOS fabrics is through an FC router, which must connect to the M-EOS fabric through an EX\_Port.

When connected by an FC router, the M-EOS firmware can operate in McDATA Open Mode (interopMode 3) or McDATA Fabric Mode (interopMode 2), but the Fabric OS switches can only operate in interopMode 0—the Brocade Native mode.

---

### NOTE

In Fabric OS v7.0.0 and later releases, Fabric OS switches cannot operate in interopmode2 or interopmode3.

---

Fabric OS provides the ability to configure any EX\_Port to connect to an M-EOS fabric by using an E\_Port without disrupting the existing services. All EX\_Port functions, such as fabric isolation and device sharing, remain the same as when connecting to a Fabric OS fabric.

---

### NOTE

M-EOS fabrics are supported only as edge fabrics and are not supported as backbone fabrics.

---

The Fibre Channel routing feature for M-EOS interoperability is not a licensed feature.

## Release Compatibility

[Table 82](#) on page 508 outlines which releases of Fabric OS remain compatible with which releases of M-EOS, when connected by FC router.

## A Interoperability overview

**TABLE 82 Fabric OS and M-EOSc interoperability compatibility matrix<sup>1</sup>**

Fabric OS	Versions of M-EOSc						v9.8	v9.9
	v6.2.0	v7.1.3x	v8.0	v9.2.0	v9.6.2	v9.7		
v5.1.0 <sup>2</sup>	Yes	No	No	No	No	No		
v5.2.0	No	Yes	Yes	No	No	No		
v5.3.0	No	No	Yes	Yes	No	No		
v6.0.0	No	No	No	No	Yes	No		
v6.1.0	No	No	No	No	Yes	Yes		
v6.1.1								
v6.1.1_enc								
v6.2.0							Yes	Yes
v6.3.0							Yes	Yes
v6.4.0							Yes	Yes
v7.0.0 and later <sup>3</sup>							Yes	Yes

1. Both Open and McDATA Fabric modes are supported.
2. Fabric OS v5.1.0 and M-EOSc v4.1.1, v5.1.2, 6.2.0 interoperate using FC routing with SilkWorm AP7420 *only*. Fabric OS and M-EOSc v7.1.3 interoperate using FC routing with the SilkWorm AP7420, or the FR4-18i blade. Fabric OS and M-EOSc v8.0.0 and v9.2.0 interoperate using FC routing with the FR4-18i blade.
3. In Fabric OS v7.0.0 and later, interoperation with M-EOS can be done only using FC Router with the M-EOS fabric connected through an EX\_Port.

[Table 83](#) outlines which releases of Fabric OS remain compatible with which releases of M-EOSn.

**TABLE 83 Fabric OS and M-EOSn interoperability compatibility matrix<sup>1</sup>**

Fabric OS	Versions of M-EOSn (McDATA Mi10K)			
	v9.2.0	v9.6.2	v9.8.0	v9.9.0
v5.3.0	Yes	No	No	No
v6.0.0	No	Yes	No	No
v6.1.0	No	Yes	No	No
v6.1.1		Yes	No	No
v6.1.1_enc		Yes	No	No
v6.2.0	No	Yes	Yes	Yes
v6.3.0	No	Yes	Yes	Yes
v6.4.0	No	Yes	Yes	Yes
v7.0.0 and later <sup>2</sup>	No	Yes	Yes	Yes

1. Both Open and McDATA Fabric modes are supported.
2. In Fabric OS v7.0.0 and later, interoperation with M-EOS can be done only using FC Router with the M-EOS fabric connected through an EX\_Port.

## Features of Connected SANs

Connected SANs provide additional features not possible with segregated SANs. Some of these features are listed below:

- Island consolidation—Uses the Fabric OS v6.0 or later FC router to connect isolated M-EOS and Fabric OS fabrics to share devices.
- Backup consolidation—Consolidates backup solutions across Fabric OS and M-EOS fabrics.
- Manageable large-scale storage network—Uses the Fabric OS v6.0 or later FC router to localize traffic while connecting devices in the metaSAN. This provides a large number of fabrics with a large number of devices.
- Sharing across an FCIP link—Shares devices between Fabric OS and M-EOS fabrics over a campus Ethernet or over long-distance IP links beyond 1000 km.
- Sharing across a long-distance FC link—Shares devices between Fabric OS fabrics over long-distance FC links as far as 300 km.
- LUN sharing—Uses your high-end RAID array connected to an M-series switch to share targets with a Fabric OS fabric; just connect one M-series switch port to an FC router EX\_Port and the one EX\_Port to the Fabric OS edge fabric.
- LSAN zone database binding—Increases FC router scalability to support more FC routers in the backbone and support more devices in the metaSAN.

Connectivity limitations of a metaSAN containing Fabric OS and M-EOS fabrics are limited only by the scalability of each individual fabric. For the latest scalability information, refer to the MyBrocade website at [www.brocade.com](http://www.brocade.com). Refer to the M-EOS fabric documentation for scalability considerations.

## Establishing interoperability

The mechanism for establishing interoperability between the FC router and the M-EOS fabric varies depending on whether the connected M-series switch is a McDATA Mi10K (M-EOSn) switch, or some other M-series (M-EOSc) switch.

When an EX\_Port is connected to an M-EOS edge fabric, the front domain ID must be within a range the edge M-EOS switch can understand. Valid values are:

- McDATA Fabric mode: 1 – 31 (interopMode 2)
- McDATA Open mode: 97 – 127 (interopMode 3)
- McDATA Open mode: 1 – 239 (M-EOSn switch only in McDATA open mode (interopMode 3) only.)

The default front domain ID assigned to the EX\_Port remains at 160 when it is created. However, when the EX\_Port is connected to the M-EOSn switch, a daemon sends a request domain ID (RDI) command that must be within the valid range M-EOS understands.

When an RDI command is sent to an M-EOSn switch with a valid domain ID defined by standards and is not within the range an M-EOSn switch understands, the RDI request is rejected. This behavior of the M-EOSn switch is different from that of M-EOSc switches.

For M-EOSc switches, if you set a front domain ID that is not within the valid range for M-EOS, then in Fibre Channel routing, a daemon internally requests a valid M-EOS domain ID. Unless you change the front domain ID, there is no impact.

When configuring an EX\_Port, you have the option to request a front domain with the **portCfgEXPort -d** command. If you request a front domain that is not within the valid range for M-EOSc, then the Fibre Channel router will internally request a valid M-EOSc domain ID.

For M-EOSc switches, after the port is properly configured and connected, running **switchShow** on the FC router displays the M-EOSc switch that is connected. On the M-EOSc switch, the **show fabric topology** command displays the front domain in WWN format (for example, 10:00:00:05:1e:7e:a9:f6). If the LSAN is configured and proxy devices are created, the proxy device appears in the name server of the edge fabric, and the translate (xlate) domain appears in the edge fabric. For M-EOSn switches, the **fc show fabric 1** command displays the front domain in WWN format, like in EOSc. The same is true for the xlate domain, but the vendor will display as *Unknown*.

## Fabric configurations for interconnectivity

To connect a Fabric OS fabric with an M-EOS fabric using an FC router, you must configure the switch on both fabrics as well as the router, as described in the following sections.

---

### NOTE

Trunking is not supported on EX\_Ports connected to the M-EOS fabric.

---

## Connectivity modes

You can connect to M-EOS fabrics in both McDATA Open mode or McDATA Fabric mode using Fibre Channel Routing as discussed in [Chapter 24, “Using FC-FC Routing to Connect Fabrics”](#). If the mode is not configured correctly, the port is disabled because of incompatibility.

To allow interconnectivity with M-EOS SANs, use the **-m** option of the **portCfgEXPort** command to indicate the connectivity mode. [Table 84](#) lists the valid parameters to use with the **-m** option to set the connectivity mode.

**TABLE 84** Values of portCfgEXPort -m option

Value	Description	Use
0	Brocade Native	Default mode.
1	McDATA Open Mode 1	When the neighboring M-EOS switch is running in open mode.
2	McDATA Fabric Mode (native mode)	When the neighboring M-EOS switch is running in native mode.

You can display the current operational mode of the EX\_Port by issuing the **portCfgEXPort** command with the port number as the only parameter.

The following command sequence is an example to connect port 5 to an M-EOS fabric in McDATA Fabric Mode:

```
switch:admin> portdisable 5
switch:admin> portcfgexport 5 -m 2
switch:admin> portenable 5
```

See [“Inter-fabric link configuration”](#) on page 478 and the *Fabric OS Command Reference* for details about the **portCfgEXPort** command.

## Configuring the FC router

When configuring a fabric on which Fabric OS is installed to connect to a Native McDATA fabric, you must configure the FC router in advance. The following procedure shows how to connect an EX\_Port of an FC router to a Native McDATA fabric configured in Fabric mode.

---

### NOTE

For additional information on configuring the FC router, refer to [Chapter 24, “Using FC-FC Routing to Connect Fabrics”](#).

---

1. To verify the Native McDATA firmware version, use the M-EOSc **show system** command.
2. To display the front domain on the M-EOS fabric, use the M-EOS **showfabric topology** command.
3. Using the **Fabric OS firmwareShow** command, make sure that the version of Fabric installed on the FC router is compatible with the M-EOS firmware version retrieved in step 2 (see [Table 82](#) on page 508 or [Table 83](#) on page 508).

```
B7800_170:admin> firmwareshow
Appl      Primary/Secondary Versions
-----
FOS       v7.0.0
          v7.0.0
```

4. On the FC router, use the **portDisable** command to disable the EX\_Port that you will use to connect to the M-EOS switch.
5. Enter the **portCfgEXPort** command to configure the port as an EX\_Port with a unique FID within the McDATA Fabric Mode.

This port can now connect to an M-EOS switch in McDATA Fabric mode or McDATA Open mode.

The following example sets port 10/13 to admin-enabled, assigns a Fabric ID of 37, and sets the M-EOS connection to McDATA Fabric Mode.

```
switch:admin_06> portcfgexport 10/13 -a 1 -f 37 -m 2
```

6. Enable the port by issuing the **portEnable** command.

```
switch:admin_06> portenable 10/13
```

If the port was persistently disabled, use the following command to enable the port:

```
switch:admin_06> portcfgpersistentenable 10/13
```

7. Physically attach the IFLs from the FC router to the switches in the edge fabrics.
  - Connect IFL1 and verify EX\_Port connectivity. Repeat for all Fabric OS fabric IFLs.
  - Connect IFL (n) for the M-EOS fabric and verify EX\_Port connectivity. Repeat for all M-EOS fabric IFLs.
8. Log in to the FC router and enter the **switchShow** command to display the M-EOS switch that is connected to the FC router EX\_Port. You can now physically attach your ISLs from the FC router to other switches in the backbone fabric.

ISLs apply only to Fabric OS switches that are not connected as an edge fabric (IFLs). When an M-EOS switch is present, it is assumed that you are creating an edge fabric.

9. Capture a SAN profile of the M-EOS and Fabric OS SANs, identifying the number of devices in each SAN.

By projecting the total number of devices and switches expected in each fabric when the LSANs are active, you can quickly determine the status of the SAN by issuing the commands **nsAllShow** and **fabricShow** on the Fabric OS fabric. The **nsAllShow** displays the global name server information and **fabricShow** displays the fabric membership information. The following examples illustrate the use of these commands.

An arrow (>) next to the switch symbolic name indicates the principal switch.

```
switch:admin_06> fabricshow
Switch ID      Worldwide Name      Enet IP Addr      FC IP Addr      Name
-----
64: fffc40 10:00:00:60:69:00:06:56 192.168.64.59    192.168.65.59    "sw5"
65: fffc41 10:00:00:60:69:00:02:0b 192.168.64.180  192.168.65.180  >"sw180"
66: fffc42 10:00:00:60:69:00:05:91 192.168.64.60   192.168.65.60   "sw60"
67: fffc43 10:00:00:60:69:10:60:1f 192.168.64.187  0.0.0.0          "sw187"
```

```
The Fabric has 4 switches
```

You can use Brocade Network Advisor to gather similar information for the M-EOS fabric. See the *Brocade Network Advisor User Manual* for information about using this management application.

When you have configured the FC router to connect to a fabric, you must create LSAN zones for the SAN. After you set up LSAN zoning, issue the **cfgShow** command to verify that the zoning is correct.

## Configuring LSAN zones in the M-EOS fabric

To ensure connectivity with devices in the Fabric OS fabric, you must set up LSAN zones in each edge fabric.

An LSAN is defined by a zone in an edge fabric. When zoning an LSAN containing multiple fabrics with switches that are not running Fabric OS, you must use port WWN. Because port IDs are not necessarily unique across fabrics, you cannot use the *domain,port* method of identification.

If the LSAN is configured and the proxy devices are created, the proxy device will show in the name server of the edge fabric and the xlate domain will show in the fabric of the edge fabric. For more details about LSAN zoning, see “[LSAN zone configuration](#)” on page 485.

The FC router can support up to 2048 zones when connected to an M-EOS v9.9 switch.

---

### NOTE

For more explanation on any of the steps in the following procedure, refer to the *Zoning User Manual* online at <http://www.brocade.com/data-center-best-practices/resource-center>. Go to the Data Center Best Practices-Resource Center section and follow the instructions for accessing documentation.

---

1. Log in to Brocade Network Advisor.
2. Create a new LSAN zone. The name of the zone must use the LSAN\_xxxx naming convention.
3. Add devices that are connected to the Fabric OS fabric. Use the device WWN when adding devices.
4. Add the newly created zone to the currently active zone set.
5. Activate the updated zone set.

## Correcting errors if LSAN devices appear in only one of the fabrics

If the LSAN devices appear in only one of the fabrics in a multiple-fabric SAN, use the following procedure to correct the problem.

1. Log in to each fabric and verify that all of the devices are physically logged in.
2. Verify that the devices are properly configured in the LSAN zone in both edge fabrics.
3. Enter the **fabricShow** command on the Fabric OS fabric.
4. Use Brocade Network Advisor to verify the M-EOS fabric, including the front and xlate domains.
5. Return to the FC router command line and issue the **fcrProxyDevShow** command to verify that the devices are configured and have been exported.

```
switch:admin> fcrproxydevshow
```

Proxy Created in Fabric	WWN	Proxy PID	Device Exists in Fabric	Physical PID	State
10	20:00:00:01:73:00:59:dd	05f001	12	610902	Imported
10	21:00:00:e0:8b:04:80:76	02f002	11	340713	Imported
10	50:06:01:68:40:04:d3:95	02f001	11	660713	Imported
11	10:00:00:00:c9:2d:3d:5c	020001	10	011500	Imported

6. Connect to the switch and configure the connection to capture console output.
7. Enter the **supportShow** (or **supportSave** if available) command, and save the output.
8. Try the following if the fabric does not appear:
  - a. Disable the EX\_Port on the connected fabric.
  - b. Enter the **portLogClear** command for the port.
  - c. Enable the port on the FC router.
  - d. Enter the **portLogDump** command for the port, capturing the output.

Use the **portLogDump** tool to troubleshoot the problem, using the command output.

If an EX\_Port connecting an FC router and an edge fabric is disabled due to an error, the error causing that port's most recent disabled state appears in the **switchShow** command output. This error appears until that port comes back online, even after the cables have been detached from the port.

To remove the error listing in the **switchShow** output, reboot the FC router. An example of the type of error displayed is 'Incompatible port mode'.

## Completing the configuration

Once you prepare the M-EOS switch and the FC router, complete the configuration by performing the following steps:

1. Physically connect the EX\_Port that you configured for the Fabric OS switch to the FC router.
2. Log in to the Fabric OS switch making sure you have admin permissions.

## A Fabric configurations for interconnectivity

3. Physically connect the configured FC router EX\_Port to the M-EOS switch, and issue the **switchShow** command on the Brocade FC router.

New domains should be visible for each IFL (front domain) that connects the Fabric OS switch to the FC router and one domain for the xlate domain.

4. Start Brocade Network Advisor and select the fabric for the M-EOS switch.
5. View the fabric topology.

New domains should be visible for each FC router connected to the M-EOS switch. Multiple connections from the same FC router appear as only a single domain. New domains also appear for every xlate domain that was created to import a remote device.

In Brocade Network Advisor, the M-EOS switch should appear green. Tab to **Zone** and verify that the zone set configuration is correct: a blue icon beside each entry indicates that the devices are logged in to the fabric.

6. Log in to the Fabric OS edge fabric switch and enter the **nsAllShow** or the **nsCamShow** command.

```
edgeswitch:admin> nsallshow
{
010e00 020000 03f001 04f002
4 Nx_Ports in the Fabric }

edgeswitch:admin> nscamshow
nscam show for remote switches:
Switch entry for 1
state rev owner
known v520 0xffffc02
Device list: count 1
Type Pid COS PortName NodeName
N 010e00; 3;10:00:00:00:00:01:00:00;10:00:00:00:00:00:01:00;
Fabric Port Name: 20:0e:00:60:69:e2:18:b6
Permanent Port Name: 10:00:00:00:00:01:00:00
Port Index: 14
Share Area: No
Device Shared in Other AD: No

Switch entry for 3
state rev owner
known v410 0xffffc02
Device list: count 1
Type Pid COS PortName NodeName
N 03f001; 2,3;10:00:00:00:c9:44:54:04;20:00:00:00:c9:44:54:04;
FC4s: FCP
NodeSymb: [36] "Emulex LP9002 FV3.92A2 DV5-5.10A10 "
Fabric Port Name: 50:00:51:e3:70:9a:3d:e8
Permanent Port Name: 10:00:00:00:c9:44:54:04
Port Index: na
Share Area: No
Device Shared in Other AD: No

Switch entry for 4
state rev owner
known v410 0xffffc02
Device list: count 1
Type Pid COS PortName NodeName
N 04f002; 3;10:00:00:00:00:03:00:00;10:00:00:00:00:00:03:00;
Fabric Port Name: 50:06:06:91:23:45:6a:13
```



```
Permanent Port Name: 10:00:00:00:00:03:00:00
Port Index: na
Share Area: No
Device Shared in Other AD: No
```

All of the devices from both LSANs should appear in the output. If the devices do not appear in the output, issue the **cfgShow** command to verify your zone configuration. Use the **cfgActvShow** command to display the zone configuration currently in effect.

The following example illustrates the use of **cfgActvShow**.

```
switch:admin> cfgactvshow
Effective configuration:
  cfg:test
  zone:lsan_san
10:00:00:00:00:03:00:00
10:00:00:00:00:01:00:00
  zone:lsan_test
50:06:01:60:38:e0:0b:a4
10:00:00:00:c9:44:54:04
```

7. Log into the FC router and run the **lsanZoneShow -s** command to verify that the designated FIDs and devices are shared among LSANs.

# A Fabric configurations for interconnectivity

## Port Indexing

---

This appendix shows how to use the **switchShow** command to determine the mapping among the port index, slot/port numbers, and the 24-bit port ID (PID) on any Brocade Backbone. Enter the **switchShow** command without parameters to show the port index mapping for the entire platform. Enter the **switchShow -slot** command for port mapping information for the ports on the blade in a specific slot. Include the **--qsfp** option to list also the QSFP number, for slots that contain core blades.

### Example of port index mapping on a CR16-4 blade in a DCX 8510-4 Backbone

This example shows the output of the **switchShow** command for a CR16-4 core blade in slot 3 of a Brocade DCX 8510-4 Backbone. The leftmost column shows the unique port index. The second and third columns show the corresponding physical slot and port numbers, respectively. The corresponding QSFP number for the port is also shown. For a core blade, no PID exists in the Address column.

```
switch:FID128:admin> switchshow -slot 3 -qsfp
switchName: switch name
switchType: 121.3
switchState: Online
switchMode: Native
switchRole: Subordinate
switchDomain: 75
switchId: fffc4b
switchWwn: 10:00:00:05:1e:4f:eb:00
zoning: ON (zoning name)
switchBeacon: OFF
FC Router: OFF
Allow XISL Use: OFF
LS Attributes: [FID: 128, Base Switch: No, Default Switch: Yes, Address Mode
0]
Index  Slot  Port  QSFP  Address  Media  Speed  State  Proto
=====
256    3     0     0     -----  id     16G    No_SigDet  FC
257    3     1     0     -----  id     16G    No_SigDet  FC
258    3     2     0     -----  id     16G    No_SigDet  FC
259    3     3     0     -----  id     16G    No_SigDet  FC
260    3     4     1     -----  --     16G    No_Module  FC
261    3     5     1     -----  --     16G    No_Module  FC
262    3     6     1     -----  --     16G    No_Module  FC
263    3     7     1     -----  --     16G    No_Module  FC
264    3     8     2     -----  --     16G    No_Module  FC
265    3     9     2     -----  --     16G    No_Module  FC
266    3    10     2     -----  --     16G    No_Module  FC
267    3    11     2     -----  --     16G    No_Module  FC
268    3    12     3     -----  --     16G    No_Module  FC
269    3    13     3     -----  --     16G    No_Module  FC
270    3    14     3     -----  --     16G    No_Module  FC
271    3    15     3     -----  --     16G    No_Module  FC
736    3    16     4     -----  --     16G    No_Module  FC
737    3    17     4     -----  --     16G    No_Module  FC
738    3    18     4     -----  --     16G    No_Module  FC
```

## B Port Indexing

```

739 3 19 4 ----- -- 16G No_Module FC
740 3 20 5 ----- -- 16G No_Module FC
741 3 21 5 ----- -- 16G No_Module FC
742 3 22 5 ----- -- 16G No_Module FC
743 3 23 5 ----- -- 16G No_Module FC
744 3 24 6 ----- -- 16G No_Module FC
745 3 25 6 ----- -- 16G No_Module FC
746 3 26 6 ----- -- 16G No_Module FC
747 3 27 6 ----- -- 16G No_Module FC
748 3 28 7 ----- id 16G Online FC E-Port
10:00:00:05:1e:39:e4:5a trunkmaster name (Trunk master)
749 3 29 7 ----- id 16G Online FC E-Port
10:00:00:05:1e:39:e4:5a trunkmaster name (Trunk master)
750 3 30 7 ----- id 16G Online FC E-Port
10:00:00:05:1e:39:e4:5a trunkmaster name (Trunk master)
751 3 31 7 ----- id 16G Online FC E-Port
10:00:00:05:1e:39:e4:5a trunkmaster name (Trunk master)

```

### Example of port index mapping on an FC16-32 blade of a Brocade DCX 8510-8 Backbone

This example shows the truncated output of the **switchShow** command for an FC16-32 port blade in slot 1 of a Brocade DCX 8510-8 Backbone. The Address column shows the PID.

```

switch:FID128:admin> switchshow -slot 1
switchName: DCX8510_8

(output truncated)

LS Attributes: [FID: 128, Base Switch: No, Default Switch: Yes, Address Mode
0]
Index Slot Port Address Media Speed State Proto
=====
0 1 0 500000 -- N16 No_Module FC
1 1 1 500100 -- N16 No_Module FC
2 1 2 500200 -- N16 No_Module FC
(output truncated)

```

### Example of port index mapping on an FC8-64 blade on a Brocade DCX Backbone.

This example shows the truncated **switchShow** output for an FC8-64 port blade on the Brocade DCX Backbone. The assignment of port index numbers to PIDs will vary depending on blade type, platform type, and slot number.

```

DCX:admin> switchshow
Index Slot Port Address Media Speed State
=====
0 1 0 0a0040 -- N8 No_Module
1 1 1 0a0140 -- N8 No_Module
2 1 2 0a0240 -- N8 No_Module
(output truncated)
768 1 48 0a00c0 -- N8 No_Module
769 1 49 0a01c0 -- N8 No_Module
770 1 50 0a02c0 -- N8 No_Module
(output truncated)
784 1 62 0a0ec0 -- N8 No_Module
783 1 63 0a0fc0 -- N8 No_Module
16 2 0 0a1040 -- N8 No_Module
17 2 1 0a1140 -- N8 No_Module
(output truncated)

```

**Example of port indexing on an FC8-64 blade on a Brocade DCX-4S Backbone.**

The Brocade DCX-4S does not need a mapping of ports on port blades because it is a one-to-one mapping. The order is sequential starting at slot 1 port 0 all the way through slot 8 port 255 for the FC8-64 blade. For core blades, the port index mapping for the blade in slot 3 begins with port index 256, and port index mapping for the core blade in slot 6 begins with port index 736. There are no shared areas on the Brocade DCX-4S.

The following example **switchShow** output is from a Brocade DCX-4S. It shows the index and PID addressing. The output has been truncated.

```
DCX-4S:admin> switchshow
Index Slot Port Address Media Speed State
=====
  0   1   0   0a0000  --   N8   No_Module
  1   1   1   0a0100  --   N8   No_Module
  2   1   2   0a0200  --   N8   No_Module
(output truncated)
 48   1  48   0a3000  --   N8   No_Module
 49   1  49   0a3100  --   N8   No_Module
 50   1  50   0a3200  --   N8   No_Module
(output truncated)
 62   1  62   0a3e00  --   N8   No_Module
 63   1  63   0a3f00  --   N8   No_Module
 64   2   0   0a4000  --   N8   No_Module
(output truncated)
```

**Example of port indexing on an FX8-24 blade on a DCX 8510-8 Backbone**

This example shows the truncated **switchShow** output for an FX8-24 application blade on the Brocade DCX 8510-8 Backbone. The assignment of port index numbers to PIDs will vary depending on blade type, platform type, and slot number.

```
switch:FID128:admin> switchshow -slot 10
switchName: my8510-8

(output truncated)

Slot   Blade Type   ID     Model Name   Status
-----
 10    AP BLADE     75     FX8-24      ENABLED

Index  Slot  Port  Address  Media  Speed  State  Proto
=====
 80    10   0     505000   id     4G     No_Light  FC
 81    10   1     505100   --     4G     No_Module  FC
 82    10   2     505200   id     4G     Mod_Inv   FC "Speed Mismatch /
Incompatible SFP"
 83    10   3     505300   --     4G     No_Module  FC
 84    10   4     505400   --     4G     No_Module  FC
(output truncated)
 95    10   15    505f00   --     --     Offline   VE
 208   10   16    50d000   --     --     Offline   VE
 209   10   17    50d100   --     4G     Offline   VE
(output truncated)
```

## B Port Indexing

### Example of port indexing on an FS8-18 blade on a DCX 8510-8 Backbone

This example shows the truncated **switchShow** output for an FS8-18 encryption blade on the Brocade DCX 8510-8 Backbone. The assignment of port index numbers to PIDs will vary depending on blade type, platform type, and slot number.

```
switch:FID128:admin> switchshow -slot 2  
switchName: myswitch
```

(output truncated)

Slot	Blade Type	ID	Model Name	Status
2	AP BLADE	43	FS8-18	ENABLED

Index	Slot	Port	Address	Media	Speed	State	Proto
16	2	0	501000	--	N8	No_Module	FC
17	2	1	501100	--	N8	No_Module	FC
18	2	2	501200	--	N8	No_Module	FC
19	2	3	501300	--	N8	No_Module	FC
20	2	4	501400	--	N8	No_Module	FC

(output truncated)

31	2	15	501f00	id	N4	No_Light	FC
----	---	----	--------	----	----	----------	----

# FIPS Support

---

## In this appendix

- [FIPS overview](#) ..... 521
- [Zeroization functions](#) ..... 521
- [FIPS mode configuration](#) ..... 523
- [Preparing the switch for FIPS](#) ..... 527

## FIPS overview

Federal information processing standards (FIPS) specify the security standards to be satisfied by a cryptographic module utilized in Fabric OS v6.0.0 and later to protect sensitive information in the switch. As part of FIPS 140-2 level 2, compliance passwords, shared secrets, and the private keys used in SSL, TLS, and system login need to be cleared out or *zeroized*. Before enabling FIPS compliance mode, a power-on self test (POST) is executed when the switch is powered on to check for the consistency of the algorithms implemented in the switch. Known-answer tests (KATs) are used to exercise various features of the algorithm and their results are displayed on the console for your reference. Conditional tests are performed whenever an RSA key pair is generated. These tests verify the randomness of the deterministic random number generator (DRNG) and non-deterministic random number generator (non-DRNG). They also verify the consistency of RSA keys with regard to signing and verification and encryption and decryption.

---

### ATTENTION

FIPS mode, when enabled, is a chassis-wide setting that affects all logical switches. Once enabled, FIPS mode cannot be disabled.

---

## Zeroization functions

Explicit zeroization can be done at the discretion of the security administrator. These functions clear the passwords and the shared secrets. [Table 85](#) lists the various keys used in the system that will be zeroized in a FIPS-compliant Fabric OS module.

**TABLE 85** Zeroization behavior

Keys	Zeroization CLI	Description
DH private keys	No command required	Keys will be zeroized within code before they are released from memory.
FCAP private key	<code>secCertUtil delete --fcapall -nowarn</code>	The <code>secCertUtil delete --fcapall</code> command removes all FCAP certificates and FCAP private keys.

**TABLE 85** Zeroization behavior (Continued)

Keys	Zeroization CLI	Description
FCSP Challenge Handshake Authentication Protocol (CHAP) Secret	secAuthSecret --remove <i>value</i>   --all	The <b>secAuthSecret --remove <i>value</i></b> command is used to remove the specified keys from the database. When the <b>secAuthSecret</b> command is used with the <b>--remove --all</b> option, then the entire key database is deleted.
Passwords	passwdDefault fipscfg --zeroize	The <b>passwdDefault</b> command removes user-defined accounts in addition to default passwords for the root, admin, and user default accounts. However, only the root account has permissions for this command. Users with securityadmin and admin permissions must use <b>fipscfg --zeroize</b> , which, in addition to removing user accounts and resetting passwords, also does the complete zeroization of the system.
RADIUS secret	aaaConfig --remove	The <b>aaaConfig --remove</b> command zeroizes the secret and deletes a configured server.
RNG seed key	No command required	/dev/urandom is used as the initial source of seed for RNG. The RNG seed key is zeroized on every random number generation.
SFTP session keys	No command required	Automatically zeroized on session termination.
SSH RSA private key	sshUtil delprivkey	Key-based SSH authentication is not used for SSH sessions.
SSH RSA public key	sshUtil delpubkeys	Key-based SSH authentication is not used for SSH sessions.
SSH session key	No command required	This key is generated for each SSH session that is established with the host. It automatically zeroizes on session termination.
Third-party keys	secCertUtil delete -fcapall	Used to zeroize third-party keys.
TLS authentication key	No command required	Automatically zeroized on session termination.
TLS pre-master secret	No command required	Automatically zeroized on session termination.
TLS private keys	secCertUtil delkey -all	The <b>secCertUtil delkey -all</b> command is used to zeroize these keys.
TLS session key	No command required	Automatically zeroized on session termination.

## Power-on self tests

A power-on self test (POST) is invoked by powering on the switch in FIPS mode and does not require any operator intervention. If any KATs fail, the switch goes into a FIPS Error state, which reboots the system to start the test again. If the switch continues to fail the FIPS POST, you will need to return your switch to your switch service provider for repair. Refer to the *Fabric OS Troubleshooting and Diagnostics Guide* for information about preparing a case for your service provider.

## Conditional tests

These tests are for the random number generators and are executed to verify the randomness of the random number generator. The conditional tests are executed each time prior to using the random number provided by the random number generator.



The results of the POST and conditional tests are recorded in the system log or are output to the local console. This action includes logging both passing and failing results. Refer to the *Fabric OS Troubleshooting and Diagnostics Guide* for instructions on how to recover if your system cannot get out of the conditional test mode.

## FIPS mode configuration

By default, the switch comes up in non-FIPS mode. You can run the `fipsCfg --enable fips` command to enable FIPS mode, but you must configure the switch first. Self-test mode must be enabled before FIPS mode can be enabled. A set of prerequisites (as shown in [Table 86](#)) must be satisfied for the system to enter FIPS mode. To be FIPS-compliant, the switch must be rebooted. For Backbones, either reboot both CPs, or power the chassis down and then up again. KATs are run on the reboot. If the KATs are successful, the switch enters FIPS mode. If the KATs fail, then the switch reboots until the KATs succeed. If the switch cannot enter FIPS mode and continues to reboot, you must return the switch to your switch service provider. For information about how to prepare a service provider case, refer to the *Fabric OS Troubleshooting and Diagnostics Guide*.

When the switch successfully reboots in FIPS mode, only FIPS-compliant algorithms are run.

[Table 86](#) lists Fabric OS features and their behaviors in FIPS and non-FIPS mode.

**TABLE 86** FIPS mode restrictions

Features	FIPS mode	Non-FIPS mode
Configupload/ download/ supportsave/ firmwaredownload	SCP/SFTP only	FTP and SCP/SFTP
DH-CHAP/FCAP hashing algorithms	SHA-1	MD5 and SHA-1
HTTP/HTTPS access	HTTPS only	HTTP and HTTPS
HTTPS algorithms	TLS/AES128 cipher suite	TLS AES 128 cipher suite
IPsec	Disabled	No restrictions
LDAP CA	CA certificate must be available.	CA certificate is optional.
Radius auth protocols	PEAP-MSCHAPv2	CHAP, PAP, PEAP-MSCHAPv2
Root account	Disabled	Enabled
Signed firmware	Mandatory firmware signature validation	Optional firmware signature validation
SNMP	Read-only operations	Read and write operations
SSH algorithms	HMAC-SHA1 (MAC) 3DES-CBC, AES128-CBC, AES192-CBC, AES256-CBC (cipher suites)	No restrictions
SSH public keys	RSA 1024 bit keys and RSA 2048 bit keys	RSA 1024 bit keys, RSA 2048 bit keys, and DSA 1024 bit keys
Telnet/SSH access	Only SSH	Telnet and SSH

## LDAP in FIPS mode

You can configure your Microsoft Active Directory server to use the Lightweight Directory Access Protocol (LDAP) while in FIPS mode. There is no option provided on the switch to configure TLS ciphers for LDAP in FIPS mode. However, the LDAP client checks if FIPS mode is set on the switch and uses the FIPS-compliant TLS ciphers for LDAP. If the FIPS mode is not set and the Microsoft Active Directory server is configured for FIPS ciphers, it uses FIPS-compliant ciphers.

[Table 87](#) lists the differences between FIPS and non-FIPS modes of operation.

**TABLE 87 FIPS and non-FIPS modes of operation**

FIPS mode	non-FIPS mode
The CA that issued the Microsoft Active Directory server certificate must be installed on the switch.	There is no mandatory CA certificate installation on the switch.
Configure FIPS-compliant TLS ciphers [TDES-168, SHA1 and RSA-1024] on the Microsoft Active Directory server. The host needs a reboot for the changes to take effect.	On the Microsoft Active Directory server, there is no configuration of the FIPS-compliant TLS ciphers.
The switch uses FIPS-compliant ciphers regardless of the Microsoft Active Directory server configuration. If the Microsoft Active Directory server is not configured for FIPS ciphers, authentication will still succeed.	The Microsoft Active Directory server certificate is validated if the CA certificate is found on the switch.
The Microsoft Active Directory server certificate is validated by the LDAP client. If the CA certificate is not present on the switch then user authentication will fail.	If the Microsoft Active Directory server is configured for FIPS ciphers and the switch is in non-FIPS mode, then user authentication will succeed.

### *Setting up LDAP for FIPS mode*

1. Log in to the switch using an account with admin or securityadmin permissions, or an account with OM permissions for the RADIUS and switchconfiguration RBAC classes of commands.
2. Enter the **dnsConfig** command to configure the DNS on the switch.

#### **Example of setting the DNS**

```
switch:admin> dnsconfig

Enter option
1 Display Domain Name Service (DNS) configuration
2 Set DNS configuration
3 Remove DNS configuration
4 Quit
Select an item: (1..4) [4] 2

Enter Domain Name: [] domain.com
Enter Name Server IP address in dot notation: [] 123.123.123.123
Enter Name Server IP address in dot notation: [] 123.123.123.124
DNS parameters saved successfully

Enter option
1 Display Domain Name Service (DNS) configuration
2 Set DNS configuration
3 Remove DNS configuration
4 Quit
Select an item: (1..4) [4] 4
```

Specify the DNS IP address using either IPv4 or IPv6. This address is needed for the switch to resolve the domain name to the IP address because LDAP initiates a TCP session to connect to your Microsoft Active Directory server. A Fully Qualified Domain Name (FQDN) is needed to validate the server identity as mentioned in the common name of the server certificate.

3. Set the switch authentication mode and add your LDAP server by using the commands shown in the following example. Provide the Fully Qualified Domain Name (FQDN) of the Microsoft Active Directory server for the host name parameter while configuring LDAP.

**Example of setting up LDAP for FIPS mode**

```
switch:admin> aaaconfig --add GEOFF5.ADLLDAP.LOCAL -conf ldap -d adldap.local
-p 389 -t 3
switch:admin> aaaconfig --authspec "ldap;local"
switch:admin> aaaconfig -show
RADIUS CONFIGURATIONS
=====
RADIUS configuration does not exist.

LDAP CONFIGURATIONS
=====

Position           : 1
Server             : GEOFF5.ADLLDAP.LOCAL
Port               : 389
Domain             : adldap.local
Timeout(s)        : 3

Primary AAA Service: LDAP
Secondary AAA Service: Switch database
```

4. Set up LDAP according to the instructions in [“LDAP configuration and Microsoft Active Directory”](#) on page 109, and then perform the following additional Microsoft Active Directory settings
  - a. To support FIPS-compliant TLS cipher suites on the Microsoft Active Directory server, allow the SCHANNEL settings listed in [Table 88](#).

**TABLE 88** Active Directory keys to modify

Key	Sub-key
Ciphers	3DES
Hashes	SHA1
Key exchange algorithm	PKCS
Protocols	TLSv1.0

- b. Enable the FIPS algorithm policy on the Microsoft Active Directory.

## LDAP certificates for FIPS mode

To utilize the LDAP services for FIPS between the switch and the host, you must generate a certificate signing request (CSR) on the Active Directory server and import and export the CA certificates. To support server certificate validation, it is essential to have the CA certificate installed on the switch and Microsoft Active Directory server. Use the **secCertUtil** command to import the CA certificate to the switch. This command will prompt for the remote IP and login credentials to retrieve the CA certificate. The CA certificate should be in any of the standard certificate formats, “.cer”, “.crt,” or “.pem”.

LDAP CA certificate file names should not contain spaces when using the **secCertUtil** command to import and export the certificate.

### *Importing an LDAP switch certificate*

This procedure imports the LDAP CA certificate from the remote host to the switch.

1. Connect to the switch and log in using an account with admin permissions, or an account with OM permissions for the PKI RBAC class of commands.
2. Enter the **secCertUtil import -ldapcert** command.

#### **Example of importing an LDAP certificate**

```
switch:admin> seccertutil import -ldapcert
Select protocol [ftp or scp]: scp
Enter IP address: 192.168.38.206
Enter remote directory: /users/aUser/certs
Enter certificate name (must have ".crt" or ".cer" ".pem" suffix):
LDAPTestCa.cer
Enter Login Name: aUser
Password: <hidden>
Success: imported certificate [LDAPTestCa.cer].
```

### *Exporting an LDAP switch certificate*

This procedure exports the LDAP CA certificate from the switch to the remote host.

1. Connect to the switch and log in using an account with admin permissions, or an account with OM permissions for the PKI RBAC class of commands.
2. Enter the **secCertUtil export -ldapcert** command.

#### **Example of exporting an LDAP CA certificate**

```
switch:admin> seccertutil export -ldapcert
Select protocol [ftp or scp]: scp
Enter IP address: 192.168.38.206
Enter remote directory: /users/aUser/certs
Enter Login Name: aUser
Enter LDAP certificate name (must have ".pem" suffix): swLdapca.pem
Password: <hidden>
Success: exported LDAP certificate
```

### *Deleting an LDAP switch certificate*

This procedure deletes the LDAP CA certificate from the switch.

1. Connect to the switch and log in using an account with admin permissions, or an account with OM permissions for the PKI RBAC class of commands.
2. Enter the **secCertUtil show -ldapcacert** command to determine the name of the LDAP certificate file.
3. Enter the **secCertUtil delete -ldapcacert file\_name** command, where *file\_name* is the name of the LDAP certificate on the switch.

#### **Example of deleting an LDAP CA certificate**

```
switch:admin> seccertutil delete -ldapcacert swLdapca.pem
WARNING!!!

About to delete certificate: swLdapca.pem
ARE YOU SURE (yes, y, no, n): [no] y
Deleted LDAP certificate successfully
```

## Preparing the switch for FIPS

It is important to prepare the switch for the following restrictions that exist in FIPS mode:

- The root account and all root-only functions are not available.
- HTTP, Telnet, RPC, and SNMP need to be disabled. Once these ports are blocked, you cannot use them to read or write data from and to the switch.
- The **configDownload** and **firmwareDownload** commands using an FTP server are blocked.

See [Table 87](#) on page 524 for a complete list of restrictions between FIPS and non-FIPS modes.

---

#### **ATTENTION**

You need the securityadmin and admin permissions to enable FIPS mode.

---

### **Overview of steps**

- Remove legacy OpenSSH DSA keys.
- *Optional:* Configure the RADIUS server or the LDAP server.
- *Optional:* Configure any authentication protocols.
- *For LDAP only:* Install an SSL certificate on the Microsoft Active Directory server and a CA certificate on the switch for using LDAP authentication.
- Ensure no filter policy rule permits access from Telnet, HTTP, or RPC.
- Create separate IP filter policies for IPv4 and IPv6 and block access to Telnet (TCP port 23), HTTP (TCP port 80), or RPC (TCP and UDP ports 897 and 898).
- Undefined ports are blocked implicitly in FIPS mode.
- Set the SNMP security level to off.
- Disable the Boot PROM access.
- Configure the switch for signed firmware.

- Disable in-flight encryption.
- Disable IPsec for Ethernet and IPsec for FCIP.
- Disable in-band management.
- Disable root access.
- Enable the KATs and the conditional tests.
- Enable FIPS.

### Enabling FIPS mode

1. Log in to the switch using an account with securityadmin permissions.
2. Enter the **sshutil delpubkeys** and **sshutil delprivkey** commands to remove legacy OpenSSH DSA keys.

These keys, which were previously the default, do migrate to Fabric OS v7.0.0 but are no longer supported in FIPS mode. You must remove them to remain FIPS compliant.

---

#### NOTE

Support for RSA keys is retained. You can implement RSA keys using the **sshutil** command.

---

3. *Optional:* Select the appropriate authentication method based on your needs:
  - If the switch is set for RADIUS, enter the **aaaConfig --change** or **aaaConfig --remove** command to modify each server to use only PEAP-MS-CHAPv2 as the authentication protocol.

The RADIUS server must also be configured to use only PEAP-MS-CHAPv2. Note that among the Windows RADIUS servers supported, only Windows 2000- and Windows 2003-based RADIUS servers may be used in a FIPS-compliant configuration.
  - If the switch is set for LDAP, refer to the instructions in [“Setting up LDAP for FIPS mode”](#) on page 524.
4. *Optional:* Set the authentication protocols.
  - a. Enter the **authUtil --set -h sha1** command to set the hash type for MD5, which is used in the DHCHAP and FCAP authentication protocols.
  - b. Enter the **authUtil --set -g n** command (where *n* represents the DH group) to set the DH group to 1, 2, 3, or 4.
5. Install the LDAP CA certificate on the switch and Microsoft Active Directory server. Refer to [“LDAP certificates for FIPS mode”](#) on page 526.
6. Enter the **ipFilter --show** command and verify that no active IP filter policy permits access to telnet, HTTP, or RPC ports, even if a higher priority policy explicitly denies such access. If an active IP policy does permit any of these ports, you must modify or deactivate the policy. Create separate policies for ipv4 and ipv6, and block access on Telnet, HTTP, and RPC ports.
  - a. Enter the **ipFilter** command to create IP Filter policies for IPv4 and IPv6. Refer to [“Creating an IP Filter policy”](#) on page 153.
  - b. Add rules to each IP Filter policy, see [“Adding a rule to an IP Filter policy”](#) on page 159. You can use the following modifications to the rule to block access to telnet, HTTP, and RPC ports:

```
ipfilter --addrule policyname -rule rule_number -sip source_IP -dp
dest_port -proto protocol -act deny
```

- The **-sip** option can be given as *any*.
  - The **-dp** option for the port numbers for Telnet, HTTP, and RPC are 23, 80, and 898, respectively.
  - The **-proto** option should be set to `tcp`.
- c. Activate each IP Filter policy. Refer to “Activating an IP Filter policy” on page 154.
  - d. Save each IP Filter policy. Refer to “Saving an IP Filter policy” on page 154.

#### Example

```
ipfilter --create http_block_v4 -type ipv4
ipfilter --addrule http_block_v4 -rule 1 -sip any -dp 80 -proto tcp -act deny
ipfilter --activate http_block_v4
```

7. Use the **snmpConfig --set seclevel** command to turn on SNMP security. When prompted to Select SNMP SET Security Level, enter **3**, for no access.

#### Example

```
switch:FID128:admin> snmpconfig --set seclevel
Select SNMP GET Security Level
(0 = No security, 1 = Authentication only, 2 = Authentication and Privacy, 3 =
No Access): (0..3) [0]
Select SNMP SET Security Level
(0 = No security, 1 = Authentication only, 2 = Authentication and Privacy, 3 =
No Access): (0..3) [0] 3
```

8. Enter the **fipsCfg --disable bootprom** command to block access to the boot PROM.

---

#### NOTE

This command can be entered only from the root account. It must be entered before disabling the root account.

---

9. Enter the **configure** command and respond to the following prompts to enable signed firmware:
  - System services: No
  - cfgload attributes: Yes
  - Enforce secure config Upload/Download: Press **Enter** to accept the default
  - Enforce firmware signature validation: Yes

#### Example

```
switch:admin> configure
Not all options will be available on an enabled switch.
To disable the switch, use the "switchDisable" command.
Configure...
System services (yes, y, no, n): [no]
...
cfgload attributes (yes, y, no, n): [no] yes
Enforce secure config Upload/Download (yes, y, no, n): [no]
Enforce firmware signature validation (yes, y, no, n): [no] yes
```

10. Enter the **userConfig --change root -e no** command to block access to the root account.

By disabling the root account, RADIUS and LDAP users with root permissions are also blocked in FIPS mode.

11. Enter the **portCfgEncrypt --disable** command to disable in-flight encryption. You must first disable the port.

### Example

```
myswitch:root> portdisable 0
myswitch:root> portcfgencrypt --disable 0
myswitch:root> portenable 0
```

12. Enter the **ipSecConfig --disable** command to disable Ethernet IPsec.
13. Disable IPsec for FCIP connections. The procedure depends on the type of extension blade used.  
  
For FX8-24 extension blades, enter the **portCfg fciptunnel [slot/]port modify -ipsec 0** command.  
  
For FR4-18i router blades, follow these steps:
  - a. Enter the **portCfg fciptunnel [slot/]port delete tunnel\_id** command to delete the FCIP tunnel.
  - b. Enter the **policy --delete ipsec** command to delete the associated IPsec policy.
  - c. Enter the **policy --delete ike** command to delete the associated IKE policy.
14. Enter the **portCfg --mgmtif delete** command to disable in band management.
15. Enter the **fipsCfg --enable selftests** command to enable KAT and conditional tests on the switch.
16. Enter the **fipsCfg --verify fips** command to verify the switch is FIPS-ready.
17. Enter the **fipsCfg --enable fips** command.
18. Reboot the switch. If a Backbone, reboot both CPs.

## Zeroizing for FIPS

1. Log in to the switch using an account with admin or securityadmin permissions, or a user account with OM permissions for the FIPSCfg RBAC class of commands.
2. Enter the **fipsCfg --zeroize** command.
3. Reboot the switch.

## Displaying FIPS configuration

1. Log in to the switch using an account with admin or securityadmin permissions, or a user account with the 0 permission for the FCIPCfg RBAC class of commands.
2. Enter the **fipsCfg --showall** command.



# Hexadecimal Conversion

---

## Hexadecimal overview

Hexadecimal, also known as hex, is a numeral system with a base of 16, usually written using unique symbols 0–9 and A–F, or a–f. Its primary purpose is to represent the binary code that computers interpret in a format easier for humans to remember. It acts as a form of shorthand, in which one hexadecimal digit takes the place of four binary bits. For example, the decimal numeral 79, with the binary representation of 01001111, is 4F (or 4f) in hexadecimal where 4 = 0100, and F = 1111.

Hexadecimal numbers can have either an *Ox* prefix or an *h* suffix. The address 0xFFFFFA is the same address as FFFFFAh. This type of address with 6 digits representing 3 bytes, is called a hex triplet. Fibre Channel uses hexadecimal notation in hex triplets to specify well-known addresses and port IDs.

### Example conversion of the hexadecimal triplet 0x616000

Notice the PID (610600 - bolded) in the **nsShow** output is in hexadecimal.

```
switch:admin> nsshow
{
  Type Pid      COS      PortName      NodeName      TTL(sec)
  N      610600;  2,3;10:00:00:00:c9:29:b3:84;20:00:00:00:c9:29:b3:84; na
  FC4s: FCP
  NodeSymb: [36] "Emulex LP9002 FV3.90A7 DV5-5.10A10 "
  Fabric Port Name: 20:08:00:05:1e:01:23:e0
  Permanent Port Name: 10:00:00:00:c9:29:b3:84
  Port Index: 6
  Share Area: No
  Device Shared in Other AD: No
  Redirect: No
  The Local Name Server has 1 entry }
```

1. Separate the 6 digits into triplets by inserting a space after every 2 digits: 61 06 00
  2. Convert each hexadecimal value to a decimal representation:
    - 61 = Domain ID = 97
    - 06 = Area (port number) = 06
    - 00 = Port (ALPA) = 0 (not used in this instance, but is used in loop, shared areas in PID assignments on blades, NPIV, and Access Gateway devices)
- Result: hexadecimal triplet 610600 = decimal triplet 97,06,00

## D Hexadecimal overview

**TABLE 89** Decimal to hexadecimal conversion table

Decimal	01	02	03	04	05	06	07	08	09	10
Hex	01	02	03	04	05	06	07	08	09	0a
Decimal	11	12	13	14	15	16	17	18	19	20
Hex	0b	0c	0d	0e	0f	10	11	12	13	14
Decimal	21	22	23	24	25	26	27	28	29	30
Hex	15	16	17	18	19	1a	1b	1c	1d	1e
Decimal	31	32	33	34	35	36	37	38	39	40
Hex	1f	20	21	22	23	24	25	26	27	28
Decimal	41	42	43	44	45	46	47	48	49	50
Hex	29	2a	2b	2c	2d	2e	2f	30	31	32
Decimal	51	52	53	54	55	56	57	58	59	60
Hex	33	34	35	36	37	38	39	3a	3b	3c
Decimal	61	62	63	64	65	66	67	68	69	70
Hex	3d	3e	3f	40	41	42	43	44	45	46
Decimal	71	72	73	74	75	76	77	78	79	80
Hex	47	48	49	4a	4b	4c	4d	4e	4f	50
Decimal	81	82	83	84	85	86	87	88	89	90
Hex	51	52	53	54	55	56	57	58	59	5a
Decimal	91	92	93	94	95	96	97	98	99	100
Hex	5b	5c	5d	5e	5f	60	61	62	63	64
Decimal	101	102	103	104	105	106	107	108	109	110
Hex	65	66	67	68	69	6a	6b	6c	6d	6e
Decimal	111	112	113	114	115	116	117	118	119	120
Hex	6f	70	71	72	73	74	75	76	77	78
Decimal	121	122	123	124	125	126	127	128	129	130
Hex	79	7a	7b	7c	7d	7e	7f	80	81	82
Decimal	131	132	133	134	135	136	137	138	139	140
Hex	83	84	85	86	87	88	89	8a	8b	8c
Decimal	141	142	143	144	145	146	147	148	149	150
Hex	8d	8e	8f	90	91	92	93	94	95	96
Decimal	151	152	153	154	155	156	157	158	159	160
Hex	97	98	99	9a	9b	9c	9d	9e	9f	a0
Decimal	161	162	163	164	165	166	167	168	169	170
Hex	a1	a2	a3	a4	a5	a6	a7	a8	a9	aa
Decimal	171	172	173	174	175	176	177	178	179	180
Hex	ab	ac	ad	ae	af	b0	b1	b2	b3	b4

**TABLE 89** Decimal to hexadecimal conversion table (Continued)

Decimal	181	182	183	184	185	186	187	188	189	190
Hex	b5	b6	b7	b8	b9	ba	bb	bc	bd	be
Decimal	191	192	193	194	195	196	197	198	199	200
Hex	bf	c0	c1	c2	c3	c4	c5	c6	c7	c8
Decimal	201	202	203	204	205	206	207	208	209	210
Hex	c9	ca	cb	cc	cd	ce	cf	d0	d1	d2
Decimal	211	212	213	214	215	216	217	218	219	220
Hex	d3	d4	d5	d6	d7	d8	d9	da	db	dc
Decimal	221	222	223	224	225	226	227	228	229	230
Hex	dd	de	df	e0	e1	e2	e3	e4	e5	e6
Decimal	231	232	233	234	235	236	237	238	239	240
Hex	e7	e8	e9	ea	eb	ec	ed	ef	ee	f0
Decimal	241	242	243	244	245	246	247	248	249	250
Hex	f1	f2	f3	f4	f5	f6	f7	f8	f9	fa
Decimal	251	252	253	254	255					
Hex	fb	fc	fd	fe	ff					

## D Hexadecimal overview

# Index

---

## A

AAA service requests, 97

access

browser support, 120

changing account parameters, 87

CP blade, 103

creating accounts, 86

deleting accounts, 87

IP address changes, 17

log in fails, 17

NTP, 28

password, changing, 19

remote access policies, 106

secure, HTTPS, 120

secure, SSL, 120

SNMP ACL, 125

accessing switches and fabrics, 129

account ID, 18

accounts

changing parameters, 87

creating, 86

deleting, 87

displaying information, 86

lockout policy, 91

lockout policy, duration, 92

lockout policy, threshold, 92

managing passwords, 88

password rules, 87

user-defined, 85

activating

Admin Domains, 350

POD, 387

ports on demand, 385

TI zones, 289

ADO, 340

AD255, 341

Adaptive Networking, 417

adding

a new switch or fabric to a zone, 263

Admin Domain members, 351

alias members, 247

end-to-end monitors, 401

members to a zone configuration, 255

ports to logical switches, 230

switches to a zone, 263

zone members, 250

addressing mode

10-bit, 36

256-area, 37

core PID, 36

fixed, 36, 324

## Admin Domains

- about, 337
  - access levels, 339
  - activating, 350
  - ADO, 340
  - AD255, 341
  - adding members, 351
  - ADList, 102
  - assigning users to, 348
  - configupload, download, 364
  - configuration, displaying, 359
  - creating, 347
  - deactivating, 351
  - defined AD configuration, 346
  - deleting, 353, 354
  - effective AD configuration, 346
  - homeAD, 102, 342
  - implementing, 346
  - interaction with Fabric OS features, 361
  - logging in to, 342
  - LSAN zones, 363
  - member types, 343
  - numbering, 337
  - physical fabric administrator, 339
  - removing from user accounts, 350
  - removing members, 352
  - renaming, 352
  - requirements, 339
  - switch WWN, 344
  - switching context, 360
  - system-defined, 340
  - transaction model, 346
  - user-defined, 340
  - using, 358
  - validating members, 358
  - zone database, 362
- alias
- adding members, 247
  - creating, 247
  - deleting, 248
  - removing members, 248
- Alias server, 4
- AP route policy, 71
- assigning users to Admin Domains, 348
- AUTH policy, 143
- authenticating users, 82
- authentication
- configuring, 97
  - local, 113
- auto-leveling, FR4-18i blade, 200, 207

## B

- backbone fabric ID, 477
- backbone-to-edge routing, 472, 477
- backing up a configuration, 180
- base switches
  - about, 218
  - creating, 227
- blade swapping, 50
- blades
  - compatibility, 44, 47
  - disabling and enabling, 44
  - enabling exceptions for the FR4-18i, 49
  - port area ID, 40
  - port identification, 40
  - port indexing, 41
  - port numbering schemes, 40
  - powering off and on, 53
  - types of, 39
- boot PROM password, 93
- bottleneck detection, 297
- Broadcast server, 4
- broadcast zones, 244
- Brocade Network Advisor, 15, 514
- Brocade Vendor-Specific Attribute, 99
- browser and Java support, 120
- browser, configuration for certificates, 123
- buffer credit management, 455
- buffer credit recovery, 463
- buffer-to-buffer credits, 67, 455

## C

- certificate authorities (CA), 121
- certificates
  - browser, configuring, 123
  - CSR, certificate signing request, 122
  - HTTPS, 116
  - installing, 123
  - obtaining, 123
  - private key, 121
  - public key, 121
  - root, 121
  - root, configuring, 124
  - security, 116
  - SSH, 116
  - SSL, 116, 120, 121, 151
  - switch, 121, 151

- changing
    - an account password, 89
    - FID of logical switch, 232
    - logical switch to base switch, 232
    - RADIUS configuration, 113
    - RADIUS servers, 113
  - clearing performance monitor counters, 405
  - clearing zone configurations, 259
  - command line interface, 16
  - compression, in-flight, 309
  - configuration file
    - backing up, 180
    - chassis section, 179
    - configDownload, 182
    - configdownload in Admin Domain context, 364
    - configupload in Admin Domain context, 364
    - configUpload in interactive mode, 181
    - display settings, 177
    - format, 178
    - information not saved, 180
    - restoring, 181
    - save to a host, 177
    - switch section, 180
  - configuring
    - access methods, Web Tools, 15
    - authentication, 97
    - browser certificates, 123
    - certificates, 120
    - changing RADIUS servers, 113
    - date and time, 25
    - Enforce LSAN tag, 492
    - FibreAlliance MIB, 125
    - for interconnectivity, 510
    - HTTPS access, 120
    - IAS, 106
    - interfabric link, 478
    - LINUX RADIUS server, 103
    - NTP, 28
    - private key, 121
    - public key, 121
    - RADIUS server, 103
    - RADIUS, changing, 113
    - root certificates, 124
    - security levels, 127
    - SNMP, 127
    - SNMP traps, 125
    - Speed LSAN tag, 492
    - SSL, 120
    - switch, 111
    - switch, RADIUS client, 105
    - Windows RADIUS client, 105
    - zone, rules for, 243
  - connecting
    - Fabric OS and M-EOS SANs, 507
    - multiple EX\_Ports to an edge fabric, 475
    - to devices, 33
  - connection
    - restrictions, 83
    - serial, 17
    - telnet, 17
  - core/edge topology and ISL trunking, 437
  - CP blade, 384
    - access, 103
  - creating
    - accounts, 86
    - Admin Domains, 347
    - alias, 247
    - base switches, 227
    - logical switches, 227
    - TI zones, 285
    - zone configurations, 254, 255
    - zones, 249
  - CSR (certificate signing request), 121, 122
  - customizing the switch name, 28
- ## D
- date and time, 25
  - deactivating
    - Admin Domains, 351
    - TI zones, 289
  - default
    - IP Policy Rules, 158
    - logical switch, 212
    - zone mode, 252, 346
  - defined
    - AD configuration, 346
    - zone configuration, 242
  - deleting
    - accounts, 87
    - Admin Domains, 353, 354
    - alias, 248
    - end-to-end monitors, 404
    - frame monitors, 408
    - logical switches, 230
    - RADIUS configuration, 112
    - TI zones, 290
    - zone configurations, 257
    - zones, 251
  - detecting bottlenecks, 297
  - devices
    - proxy, 471

- dictionary.brocade, 101
- Directory server, 3
- disabled zone configuration, 242
- disabling, 42
  - bottleneck detection, 308
  - port, 42
  - RADIUS configuration, 112
  - Virtual Fabrics, 226
  - zone configurations, 257
- displaying
  - Admin Domain configuration, 359
  - configuration settings, 177
  - logical switch configuration, 231
  - LSAN tags, 493
  - monitor counters, 404
  - RADIUS configuration, 113
  - TI zones, 290
  - trunking information, 439
- Distributed Management Server
  - FCS policy, 5
  - management server database, 6
  - topology discovery, 9
  - well-known address, 4
- Distributed Management Server
  - well-known address, 5
- domain, phantom, 65
- DPS (dynamic path selection), 71
- dynamic PID binding, 35

## E

- E\_Port, 11
- edge-to-edge routing, 477
- EE monitors
  - about, 401
  - maximum number, 401
- effective AD configuration, 346
- effective zone configuration, 242
- enabling
  - bottleneck detection, 302
  - port, 42
  - Virtual Fabrics, 225
  - zone configurations, 256
- enabling and disabling ISL trunking, 438
- encryption using SSL, 120
- encryption, in-flight, 309

- end-to-end monitors
  - deleting, 404
  - restoring configuration, 415
  - saving configuration, 415
  - setting a mask, 403
- end-to-end performance monitoring, 401
- enforce LSAN tag, 490
- equipment status, 54
- events
  - date and time, 25
- EX\_Port, 500, 511
- EX\_Ports, 12
- extended fabrics
  - about, 451
  - buffer credit management, 455
  - buffer credit recovery, 463
  - buffer requirement calculation, 457
  - buffer-to-buffer credits, 455
  - device limitations, 452
  - extended ISLs, 453
  - F\_Port buffer credits, 460
  - ISL, 456
  - long-distance mode, 457
  - port buffer credit, 456
  - QoS buffer credit requirements, 462
  - time-division multiplexing, 454
- extended ISL, 218

## F

- F\_Port, 12
- fabric
  - parameters, 66
- fabric access, 129
- fabric addresses, 35
- fabric connectivity, 55
- Fabric controller, 3
- Fabric Login, 10
- Fabric Login server, 3
- Fabric OS
  - supported protocols, 115, 116
- Fabric Wide Consistency Policy, 476
- fabric-assigned PWWN, 329
- FA-PWWN, 329
- FC router, 142
- FC routing
  - concepts, 468
  - supported platforms, 466
- FC routing types, 472



- FCAP, 143
- FC-FC Routing, 142
- FC-FC Routing and Virtual Fabrics, 501
- FC-FC routing service, 465
- FCIP link, 509
- FCR and traffic isolation, 276
- FCS policy modifying, 135
- feature licenses, 367
- Fibre Channel NAT, 65
- Fibre Channel over IP, 478
- Fibre Channel protocol auto discovery process, 12
- Fibre Channel routing, 468
- Fibre Channel services, 3
- FICON-MIB, 126
- FIPS
  - certificates, installing, 526
  - firmwareDownload, 203
  - LDAP certificates, displaying and deleting, 526
- firmware download, 192
  - auto-leveling, 207
  - Backbones, 197
  - connected switches, 195
  - FICUN CUP considerations, 193
  - FIPS, 202
  - high availability synchronization, 193
  - obtaining firmware, 195
  - process overview, 196
  - protocol, FTP and SCP, 192
  - switches, 196
  - test and restore on Backbones, 206
  - test and restore on switches, 204
  - testing different firmware versions, 206
  - USB device, 201
  - validating, 208
  - verify progress, 192
- FL\_Port, 11
- FLOGI, 12
- frame monitors
  - deleting, 408
  - restoring configuration, 415
  - saving, 408
  - saving configuration, 415
- frame redirection, 78
- FreeRADIUS, 103

## G

- G\_Port, 11

- gateway links
  - buffer credits, 451

## H

- HA failover, 89, 103
- high availability (HA), 54
- home Admin Domain, 102, 342
- HTTPS, 120
  - certificates, security, 116

## I

- IAS
  - configuring, 106
  - remote access policies, 106
- ICLs
  - about Inter-Chassis Links, 393
  - triangular topology, 397
- IFL
  - about, 468
  - configuring, 478
- implementing Admin Domains, 346
- in-flight encryption and compression, 309
- ingress rate limiting, 418
- installing
  - certificates, 123
  - certificates for FIPS, 526
- installing a root certificate to the Java plug-in, 124
- Integrated Routing, 466
- interfabric link, *see IFL*
- Internet Explorer and SSL support, 120
- interswitch link, 34
- inter-switch link (ISL), 66
- IP Filter
  - supported services, 156
- IP-NAT, 65

## IPsec

- algorithms, 169
- Authentication Header protocol, 168
- configuration on the management interface, 166
- Encapsulating Security Payload protocol, 168
- flushing SAs, 175
- IKE policies, 170
- key management, 171
- manual key entry, 171
- policies, 170
- pre-shared key, 171
- sa-proposal, 169
- security association, 169
- security certificate, 171
- traffic selector, 170
- transform set, 170

ISL, 34

## J

Java support, SSL, 120

Java version, 120

## L

license ID, 383

licensed features, 367

licenses

- Extended Fabrics, 451
- license ID, 383
- overview, 367
- purchasing keys, 386
- remove feature, 384

limiting traffic from a device, 419

Linux, configuring RADIUS on, 103

LISL, 219

local authentication

- overview, 113

local clock, 28

LOCL, 28

logging timestamp, 25

logical fabrics

- about, 216
- changing context, 235

logical ISLs, 219

logical ports, 220

logical switches

- about, 212
- allowing XISL use, 234
- changing FID, 232
- changing to a base switch, 232
- creating, 227
- deleting, 230
- displaying configuration, 231
- moving ports, 230

login

- changing password, 87
- fails, 17
- with Admin Domains, 342

login sessions, maximum allowed, 83

lossless dynamic load sharing, 75

LSAN, 485

LSAN tags, 490

LSAN zone binding, 493

LSAN zones

- in Admin Domains, 363

LUN sharing, 509

## M

M\_Port, 12

making basic connections, 33

Management server, 4

managing

- accounts, 88
- zoning configurations in a fabric, 260

mask for end-to-end monitors

- setting, 403

matching fabric parameters, 475

members

- policy, 132

M-EOS SANs, connecting with Fabric OS SANs, 507

merging zones, 254

MIB, 125

modifying

- TI zones, 288
- zoning configurations, 254

modifying the FCS policy, 135

monitoring

- end-to-end performance, 401
- trunks, 415

monitors

- clearing counters, 405

Mozilla Firefox and SSL support, 120

## N

- NAT, 65
- network address translation, see NAT
- Network OS connectivity, 465
- network security, 117
- NPIV
  - 10-bit addressing mode, 324
  - disabling, 326
  - enabling, 326
  - viewing PID login information, 328
- NTP access, 28

## P

- password, 18
  - boot PROM, 93
  - changing, 88
  - changing defaults, 19
  - limits, 19
  - recovery string, 95
  - recovery string, boot PROM password, 93
  - rules, 87
- password expiration policy, 91
- password policies, 88
- password policy
  - account lockout, 91
- password strength policy, 89
- permissions and roles, 83
- phantom domains, 471, 473
- physical fabric administrator, 339
- PID
  - 10-bit addressing mode, 36
  - swapping port area IDs, 41
- PKI (public key infrastructure), 120
- platforms, FC routing supported, 466
- PLOGI, 12
- POD
  - activating, 387
  - enabling ports, 42
- policies, routing, 63
- policy
  - members, identifying, 132
  - password expiration, 91
  - password strength, 89
- port, 42
  - activating POD, 387
  - enabling, 42
- port index, 517

- Port Login, 10
- port mirroring, 12
- port type
  - E\_Port, 11
  - EX\_Port, 12
  - F\_Port, 12
  - FL\_Port, 11
  - G\_Port, 11
  - M\_Port, 12
  - U\_Port, 11
  - VE\_Port, 12
  - VEX\_Port, 12
- primary FCS, 5
- Principal ISLs, 64
- priority groups, 67
- private key, 121
- PRLI, 12
- protocols
  - secure, 115, 116
- proxy
  - devices, 471
- proxy PID, 469, 498
- public key, 121
- public key infrastructure encryption, 120

## Q

- QoS, 419
  - buffer credit requirement, 462
- QoS over FC routers, 426
- QoS zones, 424

## R

- RADIUS, 112, 113
  - ADList, 102
  - ContextRoleList, 102
  - homeAD, 102
  - Virtual Fabrics HomeContext, 102
- RADIUS client
  - Windows configuration, 105
- RADIUS clients
  - switch configuration, 105
- RADIUS server, 100
  - configuration, 103
  - LINUX configuration, 103
- RADIUS service
  - Windows configuration, 105

- RBAC, 82
- Registered State Change Notification, 12
- remote access policies, 106
- remove feature, 384
- removing
  - Admin Domain members, 352
  - Admin Domains from user accounts, 350
  - alias members, 248
  - frame monitors, 408
  - licensed feature, 384
  - LSAN tags, 493
  - members from a zone configuration, 256
  - ports from logical switches, 230
  - zone configurations, 256
  - zone members, 250
- renaming Admin Domains, 352
- requirements
  - Admin Domains, 339
- restoring monitor configuration, 415
- Role-Based Action Control. See RBAC.
- routing
  - dynamic load sharing, 73
  - exchange-based, 71, 74
  - frame order delivery, 74
  - frame redirection, 78
  - lossless dynamic load sharing, 75
  - out-of-order exchanges, 74
  - port-based, 70, 71, 74
  - Virtual Fabrics, 72
- routing policies, 63, 71
- RSCN, 30
- rules
  - configuring zones, for, 243
  - password, 87

## S

- saved zone configuration, 242
- saving monitor configuration, 415
- scalability, 509
- secure shell (ssh), 117
- secure sockets layer, 120

- security
  - AUTH policy, 143
  - Brocade MIB, 125
  - browsers, 120
  - certificates, 116
  - encryption and SSL, 120
  - FibreAlliance MIB, 125
  - HTTPS, certificate, 116
  - IAS remote access policies, 106
  - IP policy rules, 158
  - obtaining certificates, 123
  - policies, ACL, 131
  - secure protocols, supported, 115, 116
  - setting levels, 127
  - SNMP traps, 125
  - SSH certificate, 116
  - SSL certificate, 116
- security and zoning, 262
- serial connection, 16, 17
- sessions, maximum allowed, 83
- setting
  - changing passwords, 19
  - default zone mode, 346
  - mask for end-to-end monitors, 403
  - password, boot PROM, 93
  - security level, 127
  - switch date and time, 25
  - the IP address, 22
  - time zone, 27
  - time zones, 26
  - traffic prioritization, 429
  - traffic prioritization over FC routers, 431
- setting chassis configurations, 44, 45
- SID/DID traffic prioritization, 419
- SNMP, 125
  - ACL, 125
  - agent, 125
  - attributes, 127
  - configuration changes, 127
  - configuring, 127
  - password change, 87
  - v1, 125
  - v3, 125
- specifying frame order delivery, 74
- Speed LSAN tag, 490
- SSH certificates, 116
- SSL, 120, 121, 151
- SSL certificates, security, 116
- standby CP blade, 103
- State Change Registration, 10
- static PIDs, NPIV, 38

## support

- FC router, 142
- Java version, 120
- SNMPv3 and v1, 125

## SW-EXTTRAP, 126

## switch

- access methods, Web Tools, 15
- certificates, installing, 123
- certificates, installing for FIPS, 526
- configuring, 111
- deleting RADIUS configuration, 112
- disabling port, 42
- displaying RADIUS configuration, 113
- name limitations, 30
- RADIUS client, 105
- RADIUS configuration, disabling, 112
- user-defined accounts, 85

## switch access, 129

## switch firmware version, finding, 195

## switch names, 30

## switch WWN in Admin Domains, 344

## system-defined Admin Domains, 340

## T

## tags for LSAN zones, 490

## telnet connection, 17

## TI zones, 269

- activating, 289
- changing state, 289
- creating, 285
- creating in a base fabric, 287
- deactivating, 289
- deleting, 290
- displaying, 290
- modifying, 288
- with Virtual Fabrics, 284

## time and date, 25

## time zones, 25

## Top Talkers, 410, 417

## tracking and controlling switch changes, 55

## traffic isolation over FCR, 276

## traffic isolation over FCR with Virtual Fabrics, 284

## traffic patterns

- planning for, 437

## traffic prioritization, 419

## transaction model

- managing Admin Domains, 346

## traps

- MIB, 125
- SNMP, 125

## trunking

- with TI zones, 281

## U

## U\_Port, 11

## USB device, 201

## user accounts and removing Admin Domains, 350

## user databases, 88

## user-defined

- accounts, 85
- Admin Domains, 340

## users

- assigning to Admin Domains, 348
- authenticating, 82
- using security certificates, 120

## V

## validating Admin Domain members, 358

## VE\_Port, 12

## verification check, 475

## verify

- device connectivity, 33
- high availability (HA), 54

## VEX\_Port, 12

## VF mode

- definition, 225
- See also Virtual Fabrics, 225

## viewing

- alias, 249
- zones, 251

## virtual channels, 67

## Virtual Fabrics

- and FC-FC Routing, 501
  - and ingress rate limiting, 419
  - base switches, about, 218
  - base switches, creating, 227
  - ContextRoleList, 102
  - date settings, 25
  - default logical switch, 212
  - disabling, 226
  - enabling, 225
  - extended ISL (XISL), 218
  - F\_Port trunking, 447
  - FID, changing, 232
  - HomeContext, 102
  - logical fabric context change, 235
  - logical fabrics, about, 216
  - logical ISLs (LISL), 219
  - logical switch configuration, displaying, 231
  - logical switch to base switch change, 232
  - logical switches, about, 212
  - logical switches, creating, 227
  - logical switches, deleting, 230
  - overview, 211
  - platform services, 5
  - ports, moving, 230
  - restrictions, 224
  - supported platforms, 222
  - with traffic isolation over FCR, 284
  - XISL, allowing on logical switches, 234
- VSA, 99

## W

- Web Tools access methods, configuration, 15
- well-known addresses, 3
- Windows RADIUS, configuring, 105
- working with domain IDs, 28
- WWN, 384
  - format for logical ports, 220
- WWN-based PID assignment, 37
- WWNs
  - switch WWNs in Admin Domains, 344

## X

- XISL, about, 218
- xlate domains, 473

## Z

- zone
  - adding a new switch or fabric, 263
  - adding members, 250
  - administering security, 262
  - alias, adding members, 247
  - alias, deleting, 248
  - alias, removing members, 248
  - alias, viewing, 249
  - aliases, 241
  - aliases, creating and managing, 246
  - all access, 252
  - concepts, 238
  - configurations, 241
  - configurations, adding members, 255
  - configurations, creating and maintaining, 254
  - configurations, managing, 260
  - configuring rules, 243
  - creating, 249
  - creating a configuration, 255
  - database configurations, viewing, 259
  - database size, 254
  - default zone mode, 252, 346
  - defined zone configuration, 242
  - deleting, 251
  - deleting a configuration, 257
  - disabled zone configuration, 242
  - disabling a configuration, 257
  - effective zone configuration, 242
  - enabling a configuration, 256
  - enforcement, 242
  - merging, 254
  - no access, 252
  - objects, 240
  - optimizing resources, 238
  - removing members, 250
  - removing members from a configuration, 256
  - saved zone configuration, 242
  - schemes, 241
  - splitting a fabric, 265
  - terminology, 238
  - types, 239
  - viewing, 251
  - viewing configurations, 259
- zone configuration
  - clearing, 259

- zone configurations
  - creating, 255
  - deleting, 257
  - disabling, 257
  - enabling, 256
  - removing, 256
- zone database and Admin Domains, 362
- zone, broadcast, 244
- zones
  - QoS zones, 424
  - TI zones, 269

